

# SPHV Series

## 200W Discrete Unidirectional TVS Diode

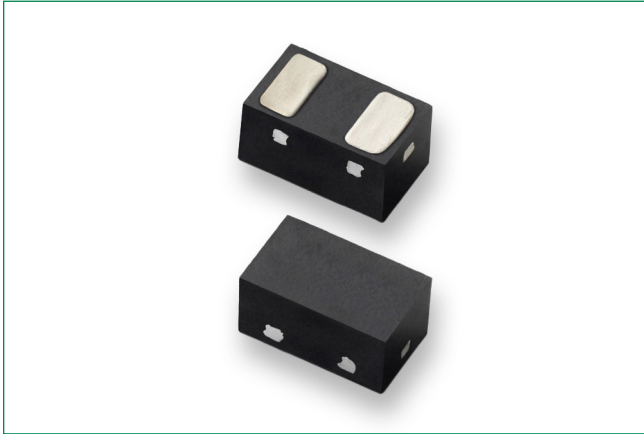

### Description

The unidirectional SPHV series is designed for use in portable applications, LED lighting modules, automotive applications, and low speed I/Os. It will protect sensitive equipment from damage due to electrostatic discharge (ESD) and other overvoltage transients.

The SPHV series can safely absorb repetitive ESD strikes above the maximum level of the IEC 61000-4-2 international standard (Level 4,  $\pm 8\text{kV}$  contact discharge) without performance degradation and safely dissipate up to 8A (SPHV12) of induced surge current (IEC 61000-4-5, 2nd Edition  $t_P=8/20\mu\text{s}$ ) with very low clamping voltages.

### Features

- ESD, IEC 61000-4-2,  $\pm 30\text{kV}$  contact,  $\pm 30\text{kV}$  air
- EFT, IEC 61000-4-4, 40A (5/50ns)
- Lightning, IEC 61000-4-5, 2nd Edition 8A ( $t_P=8/20\mu\text{s}$ , SPHV12)
- Low clamping voltage
- Low leakage current
- Small SOD882 packaging helps save board space
- AEC-Q101 qualifie
- Lead-free, Halogen-free, and RoHS Compliant

### Additional Information



Resources



Accessories



Samples

### Pinout

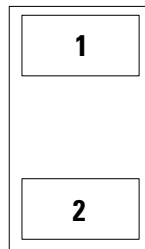

### Applications

- LED Lighting Modules
- Portable Instrumentation
- General Purpose I/O
- Mobile & Handhelds
- RS232 / RS485
- CAN and LIN Bus

### Functional Block Diagram

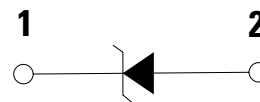

Life Support Note:

#### Not Intended for Use in Life Support or Life Saving Applications

The products shown herein are not designed for use in life sustaining or life saving applications unless otherwise expressly indicated.

# SPHV Series

## 200W Discrete Unidirectional TVS Diode

### Absolute Maximum Ratings

Symbol	Parameter	Value	Units
$P_{pk}$	Peak Pulse Power ( $t_p=8/20\mu s$ )	200	W
$T_{OP}$	Operating Temperature	-40 to 125	$^{\circ}C$
$T_{STOR}$	Storage Temperature	-55 to 150	$^{\circ}C$

**Caution:** Stresses above those listed in "Absolute Maximum Ratings" may cause permanent damage to the device. This is a stress only rating and operation of the device at these or any other conditions above those indicated in the operational sections of this specification is not implied.

### SPHV12 Electrical Characteristics (TOP=25 $^{\circ}C$ )

Parameter	Symbol	Test Conditions	Min	Typ	Max	Units
Reverse Standoff Voltage	$V_{RWM}$	$I_R \leq 1\mu A$			12.0	V
Breakdown Voltage	$V_{BR}$	$I_R = 1mA$	13.3			V
Reverse Leakage Current	$I_{LEAK}$	$V_R = 12V$			1.0	$\mu A$
Clamp Voltage <sup>1</sup>	$V_C$	$I_{PP} = 1A, t_p = 8/20\mu s, Fwd$			19.0	V
		$I_{PP} = 8A, t_p = 8/20\mu s, Fwd$			25.0	V
Dynamic Resistance <sup>2</sup>	$R_{DYN}$	TLP, $t_p = 100ns, I/O$ to GND		0.37		$\Omega$
Peak Pulse Current	$I_{PP}$	$t_p = 8/20\mu s$			8.0	A
ESD Withstand Voltage <sup>1</sup>	$V_{ESD}$	IEC61000-4-2 (Contact Discharge)	$\pm 30$			kV
		IEC61000-4-2 (Air Discharge)	$\pm 30$			kV
Diode Capacitance <sup>1</sup>	$C_{I/O-GND}$	Reverse Bias=0V, f=1MHz			60	pF

**Note:**

- Parameter is guaranteed by design and/or device characterization.
- Transmission Line Pulse (TLP) with 100ns width and 200ps rise time.

### SPHV15 Electrical Characteristics (TOP=25 $^{\circ}C$ )

Parameter	Symbol	Test Conditions	Min	Typ	Max	Units
Reverse Standoff Voltage	$V_{RWM}$	$I_R \leq 1\mu A$			15.0	V
Breakdown Voltage	$V_{BR}$	$I_R = 1mA$	16.7			V
Reverse Leakage Current	$I_{LEAK}$	$V_R = 15V$			1.0	$\mu A$
Clamp Voltage <sup>1</sup>	$V_C$	$I_{PP} = 1A, t_p = 8/20\mu s, Fwd$			22.0	V
		$I_{PP} = 5A, t_p = 8/20\mu s, Fwd$			28.0	V
Dynamic Resistance <sup>2</sup>	$R_{DYN}$	TLP, $t_p = 100ns, I/O$ to GND		0.40		$\Omega$
Peak Pulse Current	$I_{PP}$	$t_p = 8/20\mu s$			5.0	A
ESD Withstand Voltage <sup>1</sup>	$V_{ESD}$	IEC61000-4-2 (Contact Discharge)	$\pm 30$			kV
		IEC61000-4-2 (Air Discharge)	$\pm 30$			kV
Diode Capacitance <sup>1</sup>	$C_{I/O-GND}$	Reverse Bias=0V, f=1MHz			46	pF

**Note:**

- Parameter is guaranteed by design and/or device characterization.
- Transmission Line Pulse (TLP) with 100ns width and 200ps rise time.

# SPHV Series

## 200W Discrete Unidirectional TVS Diode

### SPHV24 Electrical Characteristics (TOP=25°C)

Parameter	Symbol	Test Conditions	Min	Typ	Max	Units
Reverse Standoff Voltage	$V_{RWM}$	$I_R \leq 1 \mu A$			24.0	V
Breakdown Voltage	$V_{BR}$	$I_R = 1 mA$	26.7			V
Reverse Leakage Current	$I_{LEAK}$	$V_R = 24V$			1.0	$\mu A$
Clamp Voltage <sup>1</sup>	$V_C$	$I_{PP} = 1A, t_p = 8/20\mu s, Fwd$			36.0	V
		$I_{PP} = 3A, t_p = 8/20\mu s, Fwd$			50.0	V
Dynamic Resistance <sup>2</sup>	$R_{DYN}$	TLP, $t_p = 100ns, I/O$ to GND		0.56		$\Omega$
Peak Pulse Current	$I_{PP}$	$t_p = 8/20\mu s$			3.0	A
ESD Withstand Voltage <sup>1</sup>	$V_{ESD}$	IEC61000-4-2 (Contact Discharge)	$\pm 24$			kV
		IEC61000-4-2 (Air Discharge)	$\pm 30$			kV
Diode Capacitance <sup>1</sup>	$C_{I/O-GND}$	Reverse Bias=0V, f=1MHz			32	pF

**Note:**

- Parameter is guaranteed by design and/or device characterization.
- Transmission Line Pulse (TLP) with 100ns width and 200ps rise time.

### SPHV36 Electrical Characteristics (TOP=25°C)

Parameter	Symbol	Test Conditions	Min	Typ	Max	Units
Reverse Standoff Voltage	$V_{RWM}$	$I_R \leq 1 \mu A$			36.0	V
Breakdown Voltage	$V_{BR}$	$I_R = 1 mA$	40.0			V
Reverse Leakage Current	$I_{LEAK}$	$V_R = 36V$			1.0	$\mu A$
Clamp Voltage <sup>1</sup>	$V_C$	$I_{PP} = 1A, t_p = 8/20\mu s, Fwd$			52.0	V
		$I_{PP} = 2A, t_p = 8/20\mu s, Fwd$			60.0	V
Dynamic Resistance <sup>2</sup>	$R_{DYN}$	TLP, $t_p = 100ns, I/O$ to GND		1.28		$\Omega$
Peak Pulse Current	$I_{PP}$	$t_p = 8/20\mu s$			2.0	A
ESD Withstand Voltage <sup>1</sup>	$V_{ESD}$	IEC61000-4-2 (Contact Discharge)	$\pm 15$			kV
		IEC61000-4-2 (Air Discharge)	$\pm 20$			kV
Diode Capacitance <sup>1</sup>	$C_{I/O-GND}$	Reverse Bias=0V, f=1MHz			25	pF

**Note:**

- Parameter is guaranteed by design and/or device characterization.
- Transmission Line Pulse (TLP) with 100ns width and 200ps rise time.

### Non-Repetitive Peak Pulse Power vs. Pulse Time

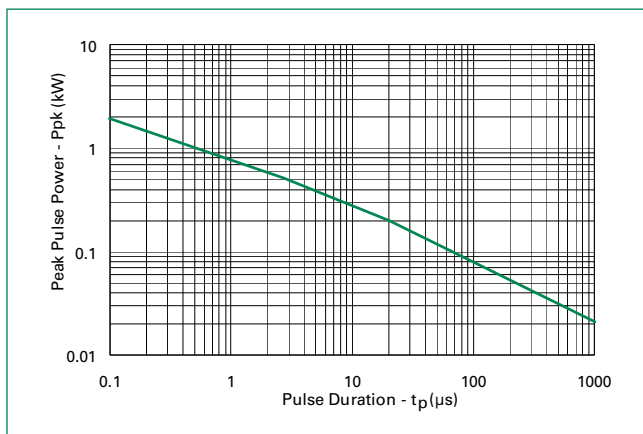

### Power Derating Curve

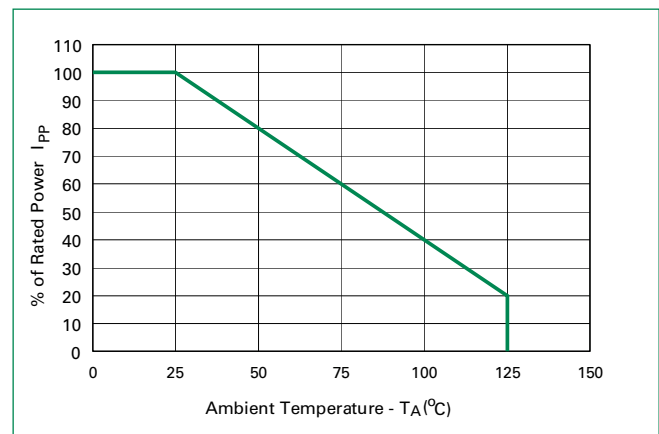

# SPHV Series

## 200W Discrete Unidirectional TVS Diode

8/20μs Pulse Waveform

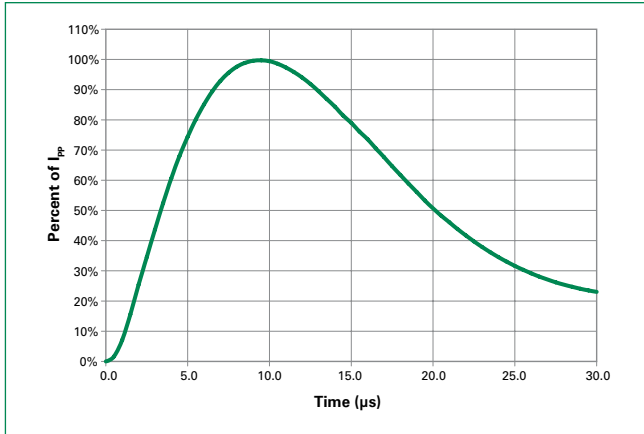

SPHV12 Transmission Line Pulsing(TLP) Plot

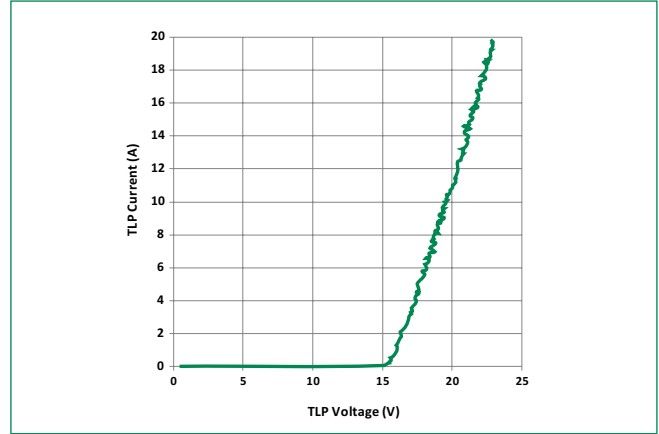

SPHV15 Transmission Line Pulsing(TLP) Plot

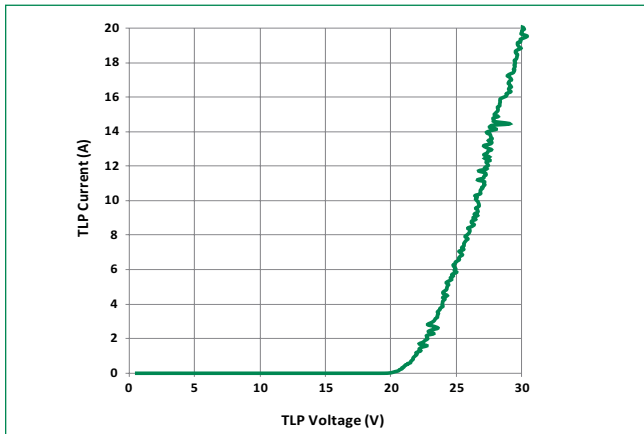

SPHV24 Transmission Line Pulsing(TLP) Plot

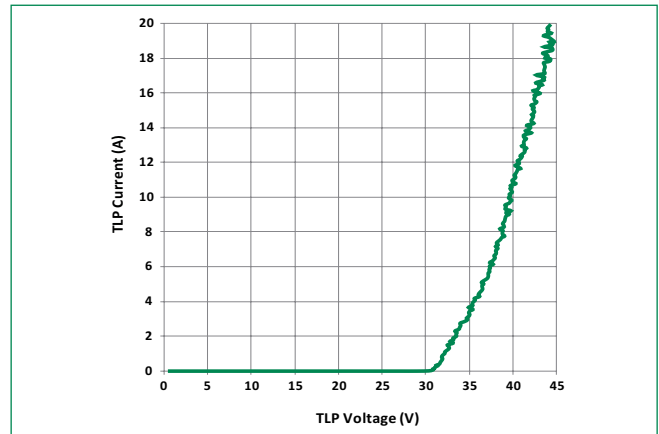

SPHV36 Transmission Line Pulsing(TLP) Plot

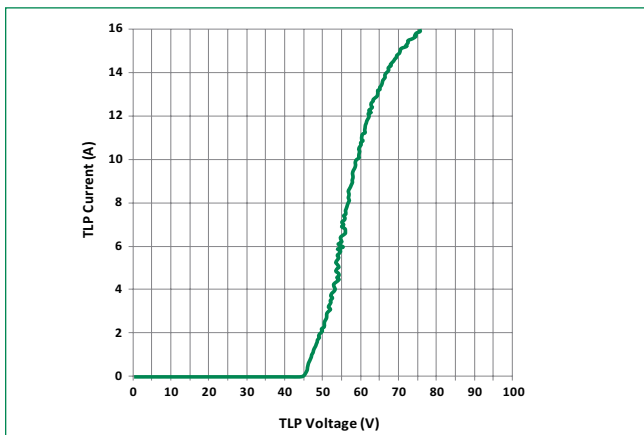

**SPHV Series****200W Discrete Unidirectional TVS Diode****Soldering Parameters**

<b>Reflow Condition</b>		Pb – Free assembly
<b>Pre Heat</b>	- Temperature Min ( $T_{s(min)}$ )	150°C
	- Temperature Max ( $T_{s(max)}$ )	200°C
	- Time (min to max) ( $t_s$ )	60 – 180 secs
<b>Average ramp up rate (Liquidus) Temp (<math>T_L</math>) to peak</b>		3°C/second max
<b><math>T_{s(max)}</math> to <math>T_L</math> - Ramp-up Rate</b>		3°C/second max
<b>Reflow</b>	- Temperature ( $T_L$ ) (Liquidus)	217°C
	- Temperature ( $t_L$ )	60 – 150 seconds
<b>Peak Temperature (<math>T_p</math>)</b>		260 <sup>+0/-5</sup> °C
<b>Time within 5°C of actual peak Temperature (<math>t_p</math>)</b>		20 – 40 seconds
<b>Ramp-down Rate</b>		6°C/second max
<b>Time 25°C to peak Temperature (<math>T_p</math>)</b>		8 minutes Max.
<b>Do not exceed</b>		260°C

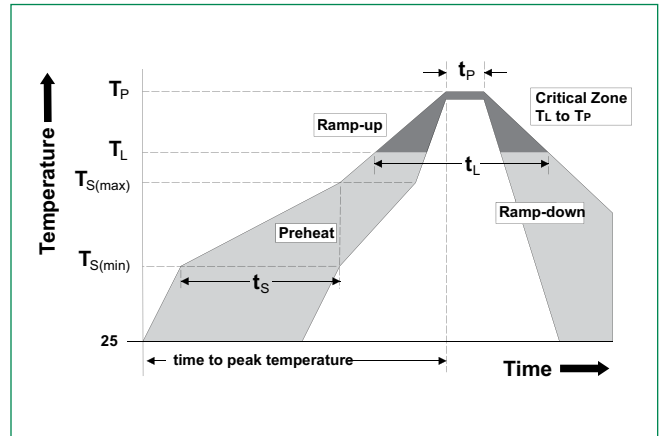
**Product Characteristics**

<b>Lead Plating</b>	Matte Tin, Pre-Plated Frame
<b>Lead Material</b>	Copper Alloy
<b>Substitute Material</b>	Silicon
<b>Body Material</b>	Molded Compound
<b>Flammability</b>	UL Recognized compound meeting flammability rating V-0

**Ordering Information**

Part Number	Package	Marking	Min. Order Qty.
SPHV12-01ETG	SOD882	U2	10000
SPHV15-01ETG		U5	
SPHV24-01ETG		U4	
SPHV36-01ETG		U6	

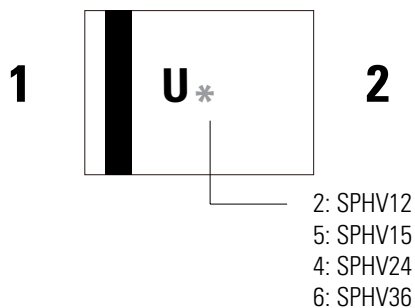
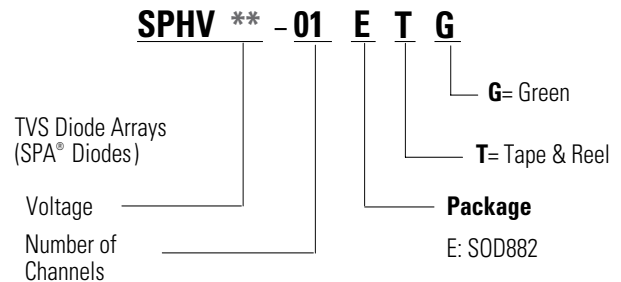
**Part Marking System****Part Numbering System**

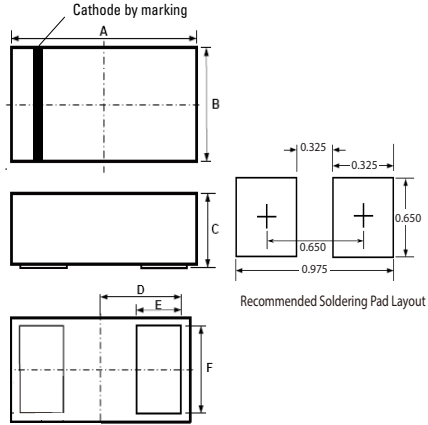
**SPHV Series****200W Discrete Unidirectional TVS Diode****Package Dimensions — SOD882(SPHVxx-01ETG)**

Symbol	Package JEDEC	SOD882				
		MO-236				
	Millimeters			Inches		
	Min	Typ	Max	Min	Typ	Max
<b>A</b>	0.90	1.00	1.10	0.037	0.039	0.041
<b>B</b>	0.50	0.60	0.70	0.022	0.024	0.026
<b>C</b>	0.40	0.50	0.60	0.016	0.020	0.024
<b>D</b>		0.45		0.018		
<b>E</b>	0.20	0.25	0.35	0.008	0.010	0.012
<b>F</b>	0.45	0.50	0.55	0.018	0.020	0.022

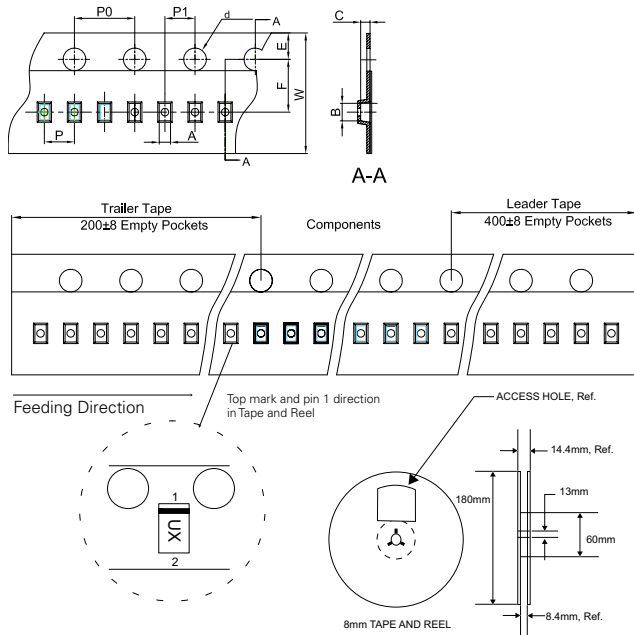
**Embossed Carrier Tape & Reel Specification**

Symbol	Millimeters
<b>A</b>	0.70+/-0.045
<b>B</b>	1.10+/-0.045
<b>C</b>	0.65+/-0.045
<b>d</b>	1.55+/-0.10
<b>E</b>	1.75+/-0.05
<b>F</b>	3.50+/-0.05
<b>P</b>	2.00+/-0.10
<b>P0</b>	4.00+/-0.10
<b>P1</b>	2.00+/-0.10
<b>W</b>	8.00 + 0.30 -0.10

**Disclaimer Notice** - Information furnished is believed to be accurate and reliable. However, users should independently evaluate the suitability of and test each product selected for their own applications. Littelfuse products are not designed for, and may not be used in, all applications. Read complete Disclaimer Notice at <http://www.littelfuse.com/disclaimer-electronics>.