

# TP1.5KE Series

## Axial Leaded – 1500W

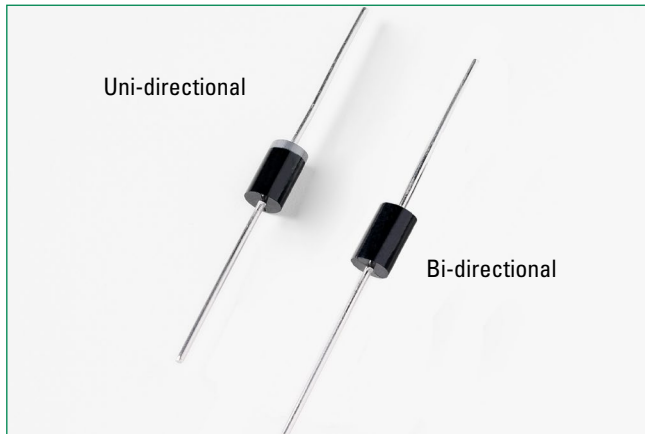

### Additional Information



Resources



Accessories



Samples

### Agency Approvals

Agency	Agency File Number
	E230531

### Maximum Ratings and Thermal Characteristics ( $T_A=25^\circ\text{C}$ unless otherwise noted)

Parameter	Symbol	Value	Unit
Peak Pulse Power Dissipation by 10/1000 $\mu\text{s}$ Test Waveform (Fig.2)(Note 1)	$P_{PPM}$	1500	W
Steady State Power Dissipation on Infinite Heat Sink at $T_c=75^\circ\text{C}$	$P_D$	6.5	W
Peak Forward Surge Current, 8.3ms Single Half Sine Wave Unidirectional Only (Note 2)	$I_{FSM}$	200	A
Maximum Instantaneous Forward Voltage at 100A for Unidirectional Only (Note 3)	$V_F$	3.5	V
Operating Junction Temperature Range	$T_J$	-55 to 175	$^\circ\text{C}$
Storage Temperature Range	$T_{STG}$	-55 to 175	$^\circ\text{C}$
Typical Thermal Resistance Junction to Lead	$R_{\theta JL}$	15	$^\circ\text{C/W}$
Typical Thermal Resistance Junction to Ambient	$R_{\theta JA}$	75	$^\circ\text{C/W}$

#### Notes:

- Non-repetitive current pulse, per Fig. 4 and derated above  $T_J$  (initial) =  $25^\circ\text{C}$  per Fig. 3.
- Measured on 8.3ms single half sine wave or equivalent square wave, duty cycle=4 per minute maximum.



### Description

The TP1.5KE Series is designed specifically to protect sensitive electronic equipment from voltage transients induced by lightning and other transient voltage events.

### Features & Benefits

- High reliability application and automotive grade AEC-Q101 rev D qualified
- Glass passivated chip junction in DO-201 Package
- 1500W peak pulse capability at 10/1000 $\mu\text{s}$  waveform, repetition rate (duty cycles):0.01%
- Fast response time: typically less than 1.0ps from 0 Volts to BV min
- Excellent clamping capability
- Typical failure mode is short from over-specified voltage or current
- Whisker test is conducted based on JEDEC JESD201A per its table 4a and 4c
- IEC 61000-4-2 ESD 30kV(Air), 30kV (Contact)
- ESD protection of data lines in accordance with IEC 61000-4-2
- EFT protection of data lines in accordance with IEC 61000-4-4
- Low incremental surge resistance
- High temperature to reflow soldering guaranteed: 260 $^\circ\text{C}$ /10sec / 0.375"(9.5mm) lead length, 5 lbs., (2.3kg) tension
- $V_{BR} @ T_J = V_{BR} @ 25^\circ\text{C} \times (1 + \alpha T \times (T_J - 25))$  ( $\alpha T$ : Temperature Coefficient, typical value is 0.1%)
- Plastic package is flammability rated V-0 per Underwriters Laboratories
- Matte tin lead-free plated
- Halogen free and RoHS compliant
- Pb-free E3 means 2nd level interconnect is Pb-free and the terminal finish material is tin(Sn) (IPC/JEDEC J-STD-609A.01)

### Applications

TVS devices are ideal for the protection of I/O interfaces,  $V_{CC}$  bus and other vulnerable circuits used in telecom, computer, industrial and consumer electronic applications.

### Functional Diagram

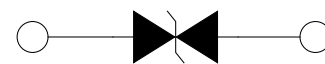

Bi-directional



Uni-directional

# TP1.5KE Series

## Axial Leaded – 1500W

### Electrical Characteristics ( $T_A=25^\circ\text{C}$ unless otherwise noted)

Part Number (Uni)	Part Number (Bi)	Reverse Stand off Voltage $V_R$ (Volts)	Breakdown Voltage $V_{BR}$ (Volts) @ $I_T$		Test Current $I_T$ (mA)	Maximum Clamping Voltage $V_C$ @ $I_{PP}$ (Volts)	Maximum Peak Pulse Current $I_{PP}$ (A)	Maximum Reverse Leakage $I_R$ @ $V_R$ ( $\mu\text{A}$ )	Agency Approval 
			MIN	MAX					
TP1.5KE12A	TP1.5KE12CA	10.20	11.40	12.60	1	16.7	91.0	5	X
TP1.5KE13A	TP1.5KE13CA	11.10	12.40	13.70	1	18.2	83.5	1	X
TP1.5KE15A	TP1.5KE15CA	12.80	14.30	15.80	1	21.2	71.7	1	X
TP1.5KE16A	TP1.5KE16CA	13.60	15.20	16.80	1	22.5	67.6	1	X
TP1.5KE18A	TP1.5KE18CA	15.30	17.10	18.90	1	25.2	60.3	1	X
TP1.5KE20A	TP1.5KE20CA	17.10	19.00	21.00	1	27.7	54.9	1	X
TP1.5KE22A	TP1.5KE22CA	18.80	20.90	23.10	1	30.6	49.7	1	X
TP1.5KE24A	TP1.5KE24CA	20.50	22.80	25.20	1	33.2	45.8	1	X
TP1.5KE27A	TP1.5KE27CA	23.10	25.70	28.40	1	37.5	40.5	1	X
TP1.5KE30A	TP1.5KE30CA	25.60	28.50	31.50	1	41.4	36.7	1	X
TP1.5KE33A	TP1.5KE33CA	28.20	31.40	34.70	1	45.7	33.3	1	X
TP1.5KE36A	TP1.5KE36CA	30.80	34.20	37.80	1	49.9	30.5	1	X
TP1.5KE39A	TP1.5KE39CA	33.30	37.10	41.00	1	53.9	28.2	1	X
TP1.5KE43A	TP1.5KE43CA	36.80	40.90	45.20	1	59.3	25.6	1	X
TP1.5KE47A	TP1.5KE47CA	40.20	44.70	49.40	1	64.8	23.5	1	X

### I-V Curve Characteristics

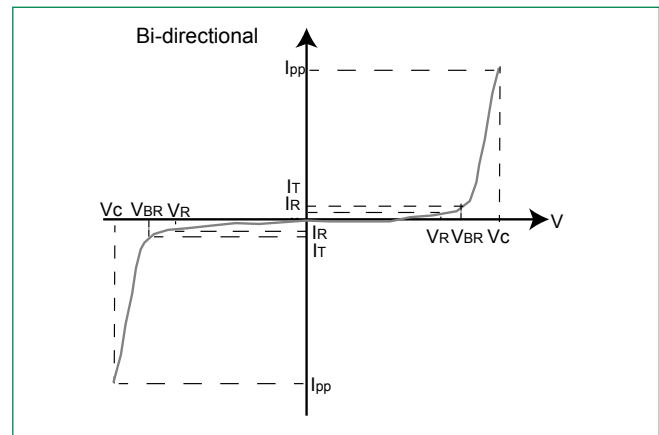
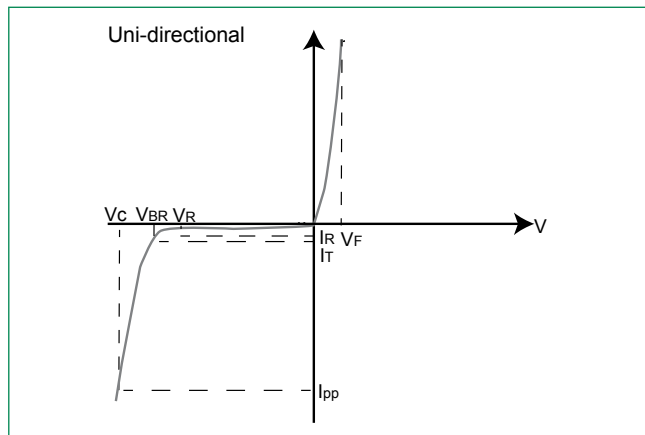

$P_{PPM}$  **Peak Pulse Power Dissipation** -- Max power dissipation

$V_R$  **Stand-off Voltage** -- Maximum voltage that can be applied to the TVS without operation

$V_{BR}$  **Breakdown Voltage** -- Maximum voltage that flows through the TVS at a specified test current ( $I_T$ )

$V_C$  **Clamping Voltage** -- Peak voltage measured across the TVS at a specified  $I_{PPM}$  (peak impulse current)

$I_R$  **Reverse Leakage Current** -- Current measured at  $V_R$

$V_F$  **Forward Voltage Drop for Uni-directional**

# TP1.5KE Series

## Axial Leaded – 1500W

### Ratings and Characteristic Curves ( $T_A=25^\circ\text{C}$ unless otherwise noted)

Figure 1 - TVS Transients Clamping Waveform

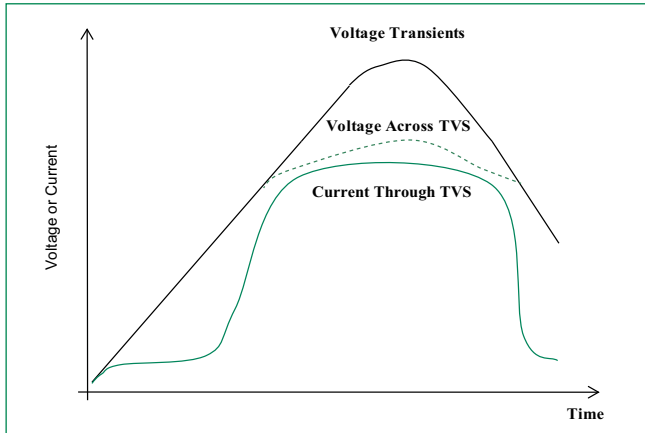

Figure 2 - Peak Pulse Power Rating

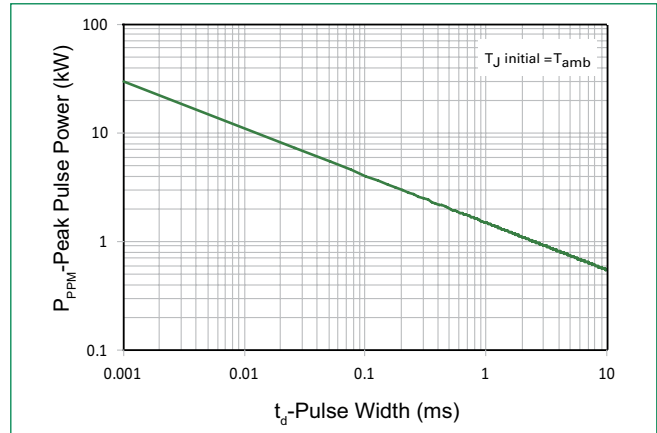

Figure 3 - Peak Pulse Power Derating Curve

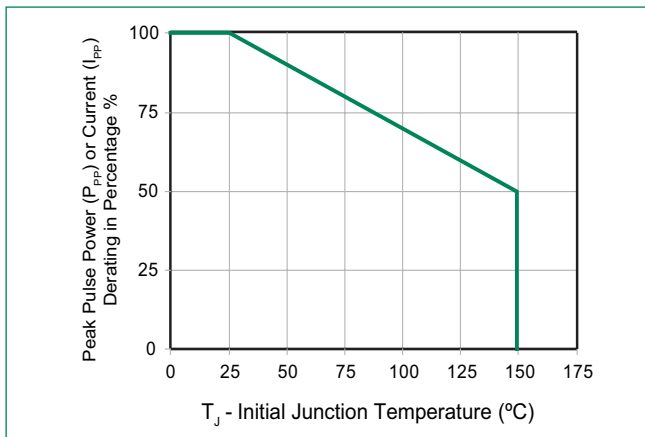

Figure 4 - Pulse Waveform

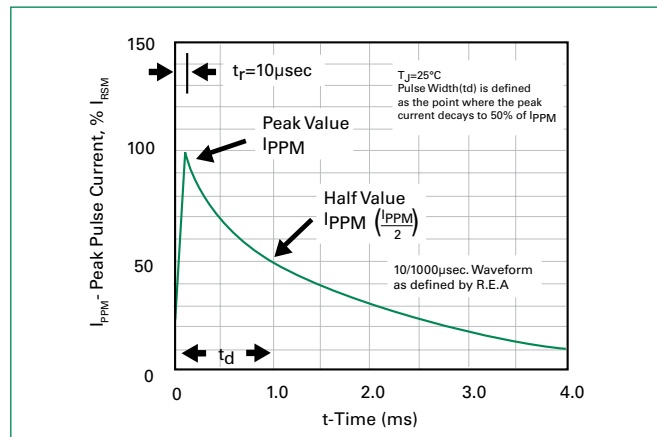

Figure 5 - Typical Junction Capacitance

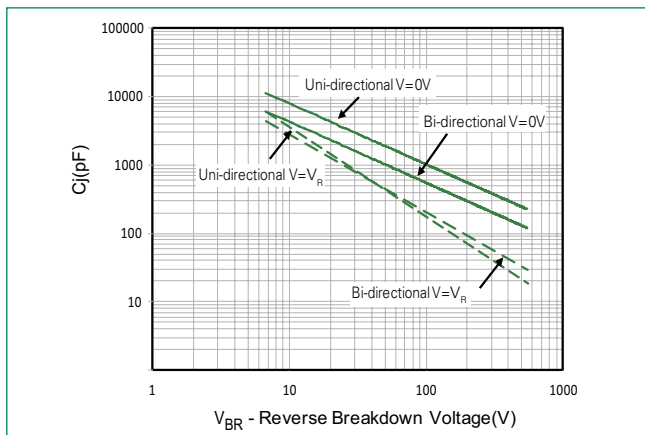
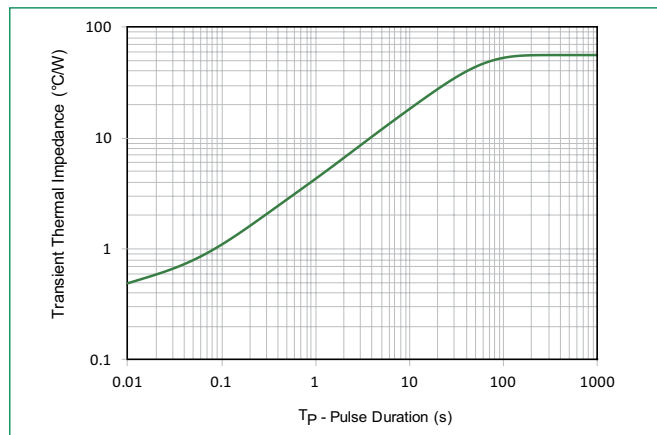

Figure 6 - Typical Transient Thermal Impedance



# TP1.5KE Series

## Axial Leaded – 1500W

### Ratings and Characteristic Curves ( $T_A=25^\circ\text{C}$ unless otherwise noted) (Continued)

Figure 7 - Maximum Non-Repetitive Peak Forward Surge Current Uni-Directional Only

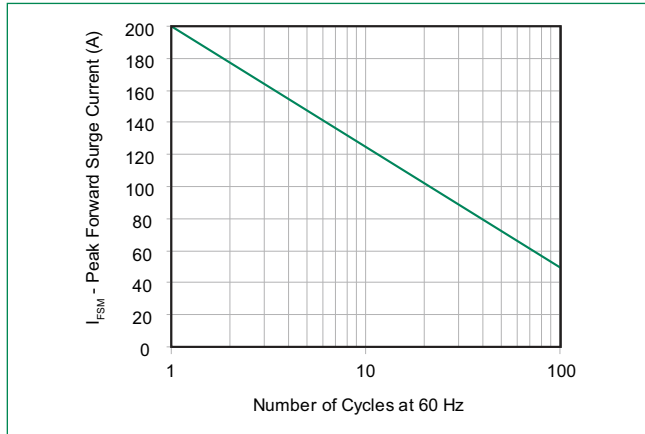
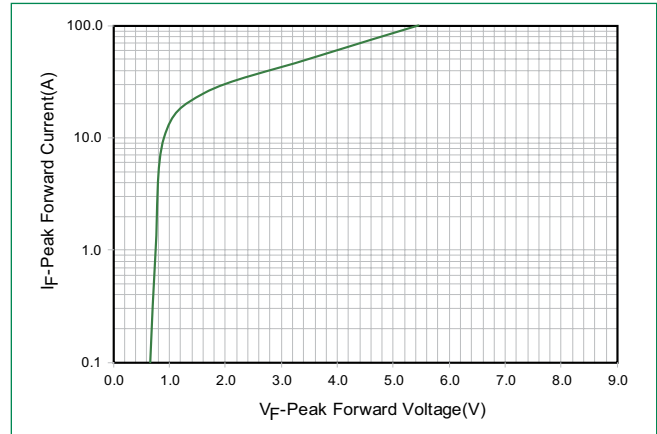
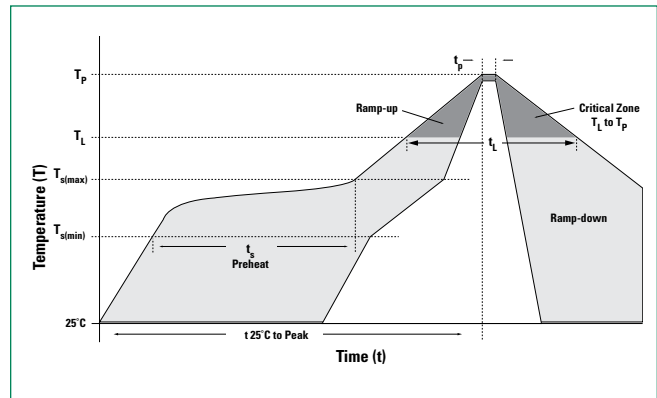

Figure 8 - Peak Forward Voltage Drop vs Peak Forward Current (Typical Values)



### Soldering Parameters

<b>Reflow Condition</b>		Lead-free assembly
<b>Pre Heat</b>	- Temperature Min ( $T_{s(\min)}$ )	150°C
	- Temperature Max ( $T_{s(\max)}$ )	200°C
	- Time (min to max) ( $t_p$ )	60 – 120 secs
<b>Average ramp up rate (Liquidus Temp (<math>T_L</math>) to peak)</b>		3°C/second max
<b><math>T_{s(\max)}</math> to <math>T_L</math> - Ramp-up Rate</b>		3°C/second max
<b>Reflow</b>	- Temperature ( $T_L$ ) (Liquidus)	217°C
	- Time (min to max) ( $t_L$ )	60 – 150 seconds
<b>Peak Temperature (<math>T_p</math>)</b>		260 <sup>+0/-5</sup> °C
<b>Time within 5°C of actual peak Temperature (<math>t_p</math>)</b>		30 seconds max
<b>Ramp-down Rate</b>		6°C/second max
<b>Time 25°C to peak Temperature (<math>T_p</math>)</b>		8 minutes max.
<b>Do not exceed</b>		260°C



### Physical Specifications

<b>Weight</b>	0.045oz., 1.2g
<b>Case</b>	JEDEC DO-201 molded plastic body over passivated junction.
<b>Polarity</b>	Color band denotes the cathode except Bipolar.
<b>Terminal</b>	Matte Tin axial leads, solderable per JESD22-B102.

### Environmental Specifications

<b>High Temp. Storage</b>	JESD22-A103
<b>HTRB</b>	JESD22-A108
<b>Temperature Cycling</b>	JESD22-A104
<b>H3TRB</b>	JESD22-A101
<b>RSH</b>	JESD22-B106

### Flow/Wave Soldering (Solder Dipping)

<b>Peak Temperature :</b>	265°C
<b>Dipping Time :</b>	10 seconds
<b>Soldering :</b>	1 time

# TP1.5KE Series

## Axial Leaded – 1500W

### Dimensions

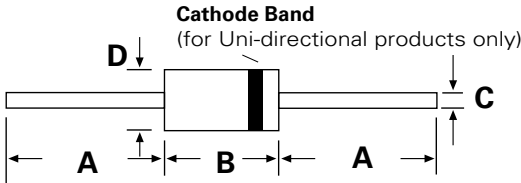

Dimensions	Inches		Millimeters	
	Min	Max	Min	Max
<b>A</b>	1.000	-	25.40	-
<b>B</b>	0.285	0.375	7.20	9.50
<b>C</b>	0.038	0.042	0.96	1.07
<b>D</b>	0.190	0.210	4.80	5.30

### Part Numbering System

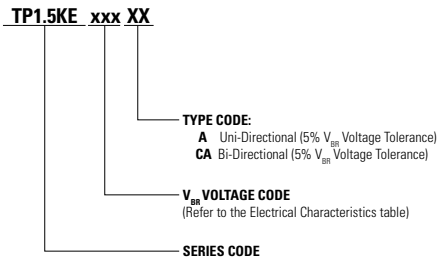

### Part Marking System

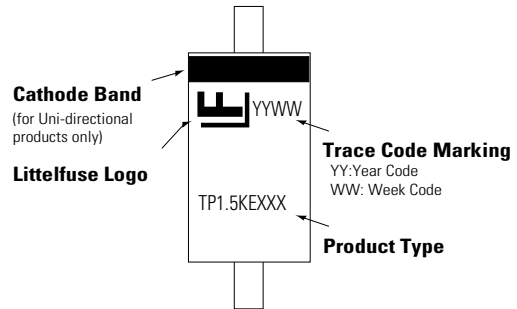

### Packaging

Part Number	Component Package	Quantity	Packaging Option	Packaging Specification
TP1.5KExxxXX	DO-201	1200	Tape & Reel	EIA STD RS-296

### Tape and Reel Specification

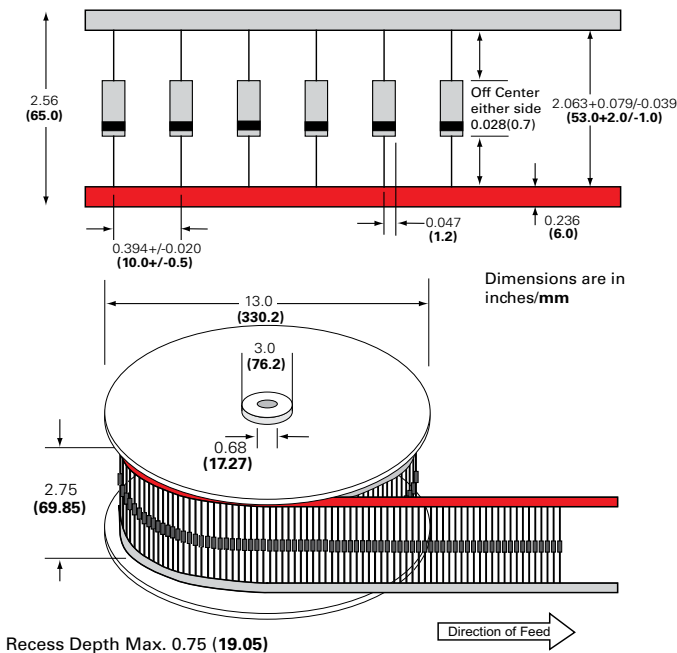

**Disclaimer Notice** - Information furnished is believed to be accurate and reliable. However, users should independently evaluate the suitability of and test each product selected for their own applications. Littelfuse products are not designed for, and may not be used in, all applications. Read complete Disclaimer Notice at: [www.littelfuse.com/disclaimer-electronics](http://www.littelfuse.com/disclaimer-electronics)