

PART NUMBER	UPC CODE
LDM3CU02	07945831140

REVISION		
REV	DATE	DESCRIPTION
A	5/5/23	526436GCP - RELEASE MRY

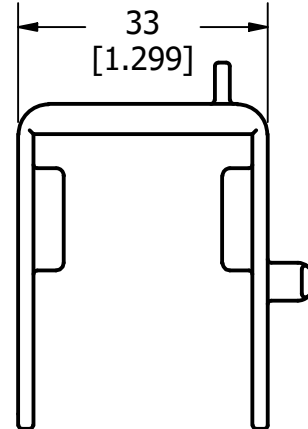
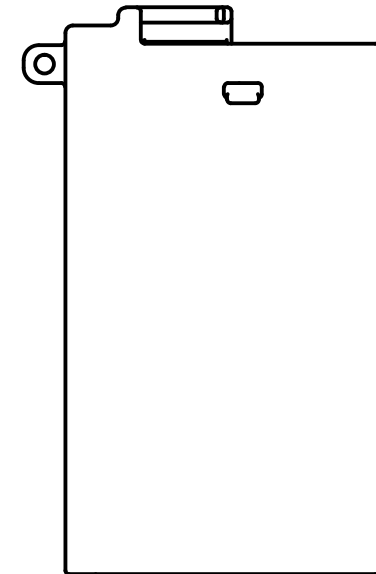
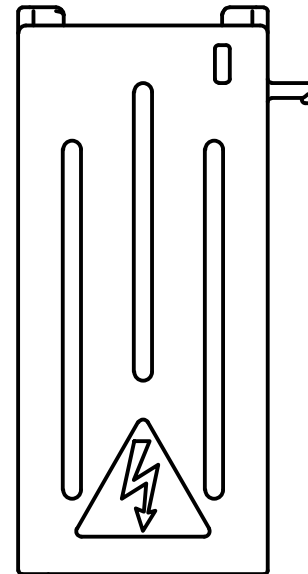
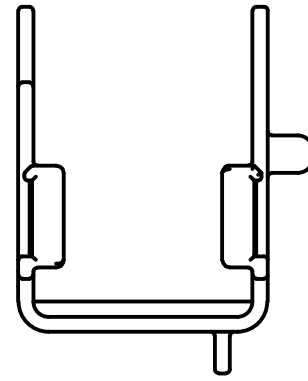
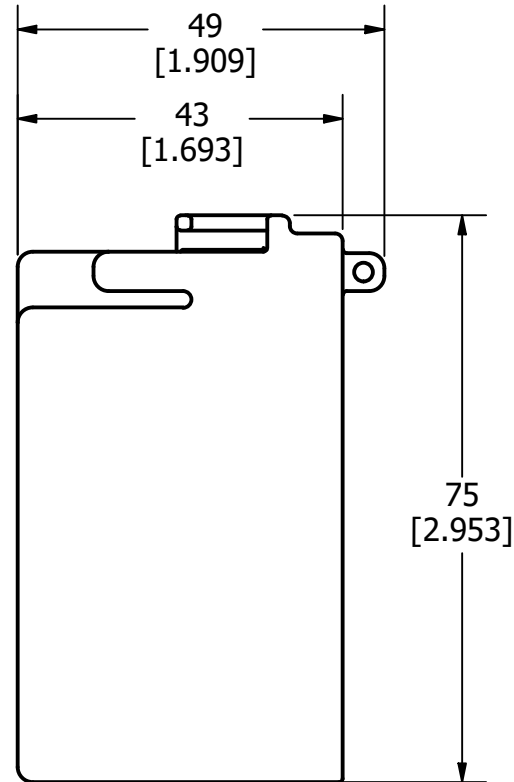

1	NO	COMPONENT NO	DESCRIPTION	QTY/M	U/M
---	----	--------------	-------------	-------	-----

BILL OF MATERIAL

<S>	CRITICAL CHARACTERISTIC FOR PART SAFETY/COMPLIANCE
●	DENOTES CRITICAL CHARACTERISTICS.
CPK	DENOTES CPK DIMENSIONS, -MINIMUM CPK VALUE
⊠	DENOTES A CHARACTERISTIC THAT PROVIDES AN INDICATION OF PROCESS PERFORMANCE. PROCEDURE FOR MEASUREMENT AND TRACKING TO BE DEFINED IN LITTELFUSE INSPECTION INSTRUCTIONS.
CP	DENOTES CP DIMENSIONS, -MINIMUM CP VALUE MUST BE WITHIN THE DIMENSIONAL LIMITATIONS SHOWN ON DRAWING AND INITIALLY LOCATED TO ALLOW FOR MAXIMUM TOOL LIFE.

B

MATL SPEC	FINISH		
DRW myork	DATE 1/10/2023	SCALE NTS	FINISH GOOD WT GRAMS/PIECE

UNLESS OTHERWISE SPECIFIED, DIMENSIONS ARE IN MILLIMETERS, DIMENSIONS IN BRACKETS [] ARE INCHES DIMENSIONING AND DO NOT INCLUDE PLATING. TOLERANCING TO BE INTERPRETED IN ACCORDANCE WITH ANSI Y14.5M-1994

3RD ANGLE PROJECTION	
----------------------	--

TITLE TERMINAL SHROUD 3P 60A OUTLINE

Littelfuse CHICAGO, ILLINOIS 60631	REVISION A	DRWG NO. OL-LDM3CU02	SHEET 1 OF 1
--	---------------	-------------------------	--------------