

MM	IN
0.50	0.020
1.52	0.060
2.74	0.108
3.42	0.135
4.75	0.187
5.58	0.219
7.14	0.281
9.39	0.370
16.66	0.656
26.92	1.060
35.05	1.380
38.35	1.510
52.57	2.070

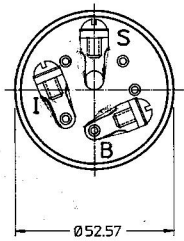
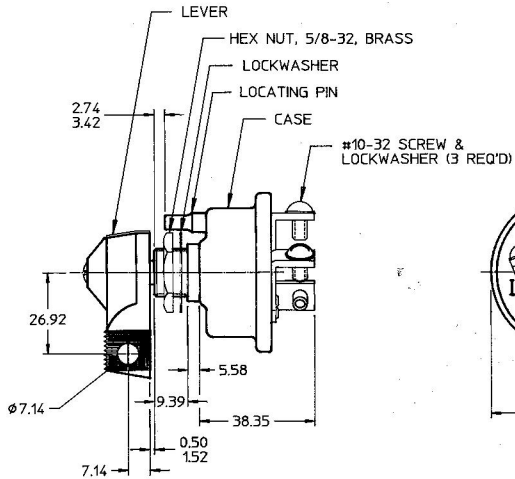
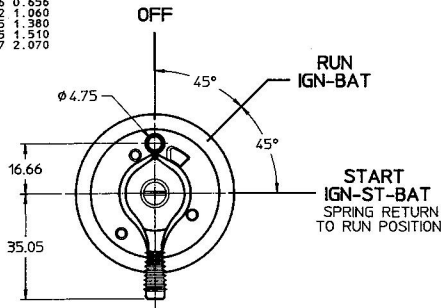

APPLICABLE SAE STANDARD OR RECOMMENDED PRACTICE SAE 259

S	START
B	BATTERY
I	IGNITION
LEGEND	

Confidential Property of Cole Hersee

- NOTES:
1. SILVER LAMINATED CONTACT SURFACES AT START POSITION
 2. RATING: 70 AMPS @ 12VDC (COMBINED LOAD)
 3. DESIGNED FOR MAX. OF 70 AMPS AT START CIRCUIT (MAY PERMIT ELIMINATION OF SOLENOID)
 4. *O* RING SEALED AT MOUNTING STEM
 5. ALL STEEL PARTS PLATED
 6. ALL DIMENSIONS REF. ONLY

DO NOT SCALE

METRIC

LET.	WAS	DATE	BY	LET.	WAS	DATE	BY	MATERIAL	DRAWN	CHK	APVD	SCALE	EX25279	DATE DRAWN
								FRESH	BL			1:1		6/1/93
												Cole Hersee Co.		DATE BLUEPRINTED
										28 OLD COLONY AVENUE, BOSTON, MA., U.S.A., 02127		SWITCH, ROTARY 3 POS		95521-08
								TOLERANCES DECIMAL ± ANGLE ±						
								A ECJ 01041		1-17-91		PTE		
								ISSUED		4/2/93		AF		