

1. COMPUTER TO RELAY CONNECTION

Connect the SE-145 to the network using a standard Ethernet patch cable. Use of a crossover cable to connect the SE-145 directly to the computer running SE-MON-GFGC is not recommended. A typical router will assign an IP address to all connected computers that are using DHCP. The SE-145 does not support the use of DHCP.

If the SE-145 is being set-up for first time, it is recommended to only have one SE-145 connected to the network to prevent communication errors.

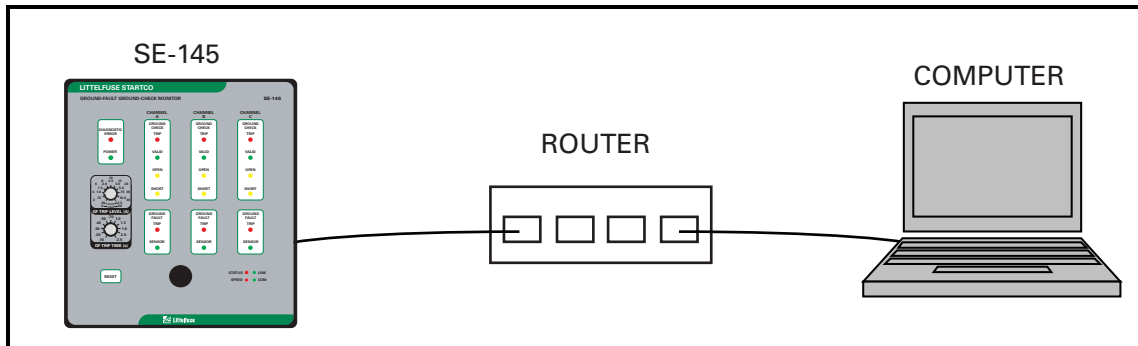

FIGURE 1. Computer to Relay Connection.