

**High Voltage
XPT™ IGBT
w/ Diode**
**IXYT12N250CV1HV
IXYH12N250CV1HV**

$$V_{CES} = 2500V$$

$$I_{C110} = 12A$$

$$V_{CE(sat)} \leq 4.50V$$

$$t_{fi(typ)} = 136ns$$



Symbol	Test Conditions	Maximum Ratings	
V_{CES}	$T_J = 25^\circ C$ to $175^\circ C$	2500	V
V_{CGR}	$T_J = 25^\circ C$ to $175^\circ C$, $R_{GE} = 1M\Omega$	2500	V
V_{GES}	Continuous	± 20	V
V_{GEM}	Transient	± 30	V
I_{C25}	$T_C = 25^\circ C$	28	A
I_{C110}	$T_C = 110^\circ C$	12	A
I_{F110}	$T_C = 110^\circ C$	14	A
I_{CM}	$T_C = 25^\circ C$, 1ms	80	A
SSOA (RBSOA)	$V_{GE} = 15V$, $T_{VJ} = 150^\circ C$, $R_G = 10\Omega$ Clamped Inductive Load	$I_{CM} = 48$ 1500	A V
P_C	$T_C = 25^\circ C$	310	W
T_J		-55 ... +175	$^\circ C$
T_{JM}		175	$^\circ C$
T_{stg}		-55 ... +175	$^\circ C$
T_L	Maximum Lead Temperature for Soldering	300	$^\circ C$
T_{SOLD}	1.6 mm (0.062in.) from Case for 10s	260	$^\circ C$
M_d	Mounting Torque (TO-247HV)	1.13/10	Nm/lb.in.
Weight	TO-268HV	4	g
	TO-247HV	6	g

TO-268HV (IXYT)

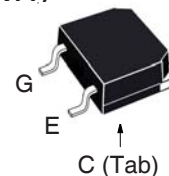

TO-247HV (IXYH)

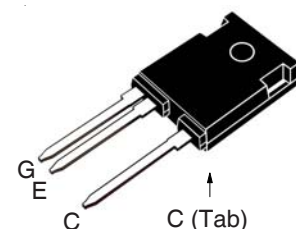

G = Gate C = Collector
E = Emitter Tab = Collector

Features

- High Voltage Packages
- High Blocking Voltage
- High Peak Current Capability
- Low Saturation Voltage

Advantages

- Low Gate Drive Requirement
- High Power Density

Applications

- Switch-Mode and Resonant-Mode Power Supplies
- Uninterruptible Power Supplies (UPS)
- Laser Generators
- Capacitor Discharge Circuits
- AC Switches

Symbol	Test Conditions ($T_J = 25^\circ C$, Unless Otherwise Specified)	Characteristic Values		
		Min.	Typ.	Max.
BV_{CES}	$I_C = 250\mu A$, $V_{GE} = 0V$	2500		V
$V_{GE(th)}$	$I_C = 250\mu A$, $V_{CE} = V_{GE}$	3.0		5.0 V
I_{CES}	$V_{CE} = V_{CES}$, $V_{GE} = 0V$			25 μA
	$V_{CE} = 0.8 \cdot V_{CES}$, $V_{GE} = 0V$ $T_J = 150^\circ C$			3.5 mA
I_{GES}	$V_{CE} = 0V$, $V_{GE} = \pm 20V$			± 100 nA
$V_{CE(sat)}$	$I_C = 12A$, $V_{GE} = 15V$, Note 1 $T_J = 150^\circ C$	3.70		V
		5.55		V

Symbol Test Conditions		Characteristic Values		
(T _J = 25°C Unless Otherwise Specified)		Min.	Typ.	Max.
g_{fs}	I _C = 12A, V _{CE} = 10V, Note 1	7	12	S
R_{Gi}	Gate Input Resistance		7.5	Ω
C_{ies}	V _{CE} = 25V, V _{GE} = 0V, f = 1MHz		1370	pF
C_{oes}			65	pF
C_{res}			16	pF
Q_{g(on)}	I _C = 12A, V _{GE} = 15V, V _{CE} = 0.5 • V _{CES}		56	nC
Q_{ge}			6	nC
Q_{gc}			28	nC
t_{d(on)}	Inductive load, T_J = 25°C I _C = 12A, V _{GE} = 15V V _{CE} = 0.5 • V _{CES} , R _G = 10Ω Note 2		12	ns
t_{ri}			16	ns
E_{on}			3.56	mJ
t_{d(off)}			167	ns
t_{fi}			136	ns
E_{off}			1.70	mJ
t_{d(on)}	Inductive load, T_J = 150°C I _C = 12A, V _{GE} = 15V V _{CE} = 0.5 • V _{CES} , R _G = 10Ω Note 2		12	ns
t_{ri}			20	ns
E_{on}			4.78	mJ
t_{d(off)}			195	ns
t_{fi}			138	ns
E_{off}			1.95	mJ
R_{thJC}				0.48 °C/W
R_{thCS}	TO-247HV	0.21		°C/W

Reverse Diode (FRED)

Symbol Test Conditions		Characteristic Value		
(T _J = 25°C, Unless Otherwise Specified)		Min.	Typ.	Max.
V_F	I _F = 12A, V _{GE} = 0V, Note 1		4.2	4.5 V
I_{RM}	I _F = 12A, V _{GE} = 0V, -di _F /dt = 500A/μs, V _R = 1200V, T _J = 150°C		22	A
t_{rr}			165	ns
R_{thJC}				0.80 °C/W

Notes:

1. Pulse test, t ≤ 300μs, duty cycle, d ≤ 2%.
2. Switching times & energy losses may increase for higher V_{CE}(clamp), T_J or R_G.

ADVANCE TECHNICAL INFORMATION

The product presented herein is under development. The Technical Specifications offered are derived from a subjective evaluation of the design, based upon prior knowledge and experience, and constitute a "considered reflection" of the anticipated result. IXYS reserves the right to change limits, test conditions, and dimensions without notice.

IXYS Reserves the Right to Change Limits, Test Conditions, and Dimensions.

IXYS MOSFETs and IGBTs are covered by one or more of the following U.S. patents:	4,835,592	4,931,844	5,049,961	5,237,481	6,162,665	6,404,065 B1	6,683,344	6,727,585	7,005,734 B2	7,157,338B2
	4,860,072	5,017,508	5,063,307	5,381,025	6,259,123 B1	6,534,343	6,710,405 B2	6,759,692	7,063,975 B2	
	4,881,106	5,034,796	5,187,117	5,486,715	6,306,728 B1	6,583,505	6,710,463	6,771,478 B2	7,071,537	

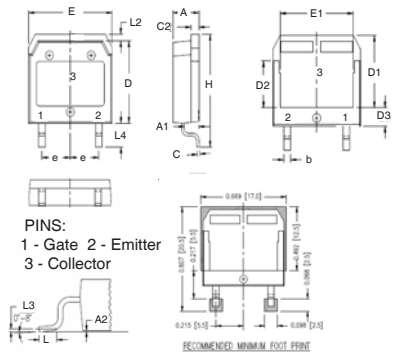
TO-268HV Outline

PINS:
 1 - Gate 2 - Emitter
 3 - Collector

SYM	INCHES		MILLIMETER	
	MIN	MAX	MIN	MAX
A	.193	.201	4.90	5.10
A1	.106	.114	2.70	2.90
A2	.001	.010	0.02	0.25
b	.045	.057	1.15	1.45
C	.016	.026	0.40	0.65
C2	.057	.063	1.45	1.60
D	.543	.551	13.80	14.00
D1	.465	.476	11.80	12.10
D2	.295	.307	7.50	7.80
D3	.114	.126	2.90	3.20
E	.624	.632	15.85	16.05
E1	.524	.535	13.30	13.60
e	.215	BSC	5.45	BSC
H	.736	.752	18.70	19.10
L	.067	.079	1.70	2.00
L2	.039	.045	1.00	1.15
L3	.010	BSC	0.25	BSC
L4	.150	.161	3.80	4.10

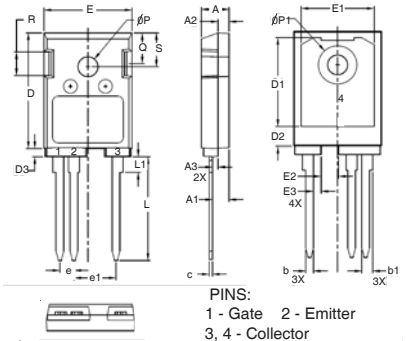
TO-247HV Outline

PINS:
 1 - Gate 2 - Emitter
 3, 4 - Collector

SYM	INCHES		MILLIMETERS	
	MIN	MAX	MIN	MAX
A	.193	.201	4.90	5.10
A1	.114	.122	2.90	3.10
A2	.075	.083	1.90	2.10
A3	.035	.043	0.90	1.10
b	.053	.059	1.35	1.50
b1	.075	.083	1.90	2.10
c	.022	.030	0.55	0.75
D	.819	.843	20.80	21.40
D1	.638	.646	16.20	16.40
D2	.134	.146	3.40	3.70
D3	.055	.063	1.40	1.60
E	.622	.638	15.80	16.20
E1	.520	.528	13.20	13.40
E2	.118	.126	3.00	3.20
E3	.051	.059	1.30	1.50
e	.100	BSC	2.54	BSC
e1	.300	BSC	7.62	BSC
L	.732	.748	18.60	19.00
L1	.106	.118	2.70	3.00
øP	.138	.142	3.50	3.60
øP1	.272	.280	6.90	7.10
Q	.216	.224	5.50	5.70
R	.165	.169	4.20	4.30
S	.240	.248	6.10	6.30

Fig. 1. Output Characteristics @ $T_J = 25^\circ\text{C}$

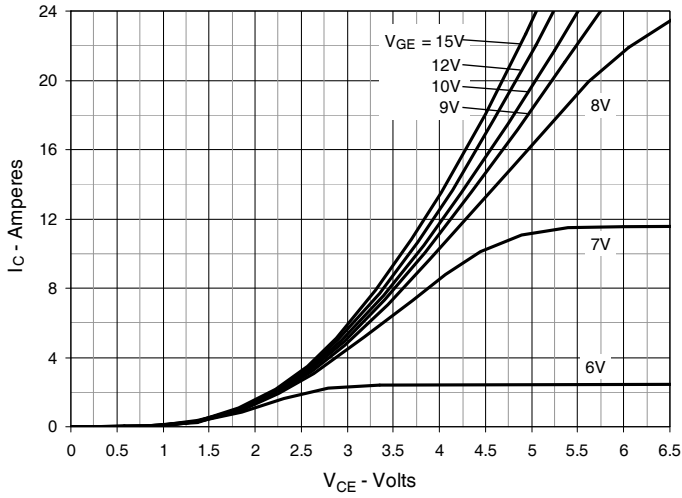

Fig. 2. Extended Output Characteristics @ $T_J = 25^\circ\text{C}$

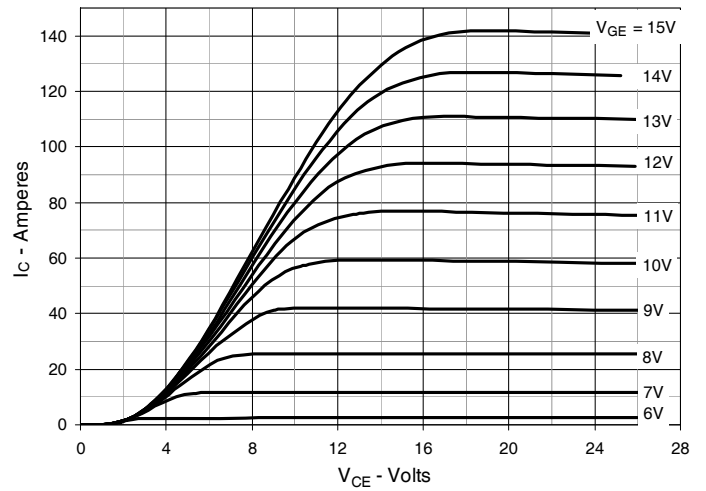

Fig. 3. Output Characteristics @ $T_J = 150^\circ\text{C}$

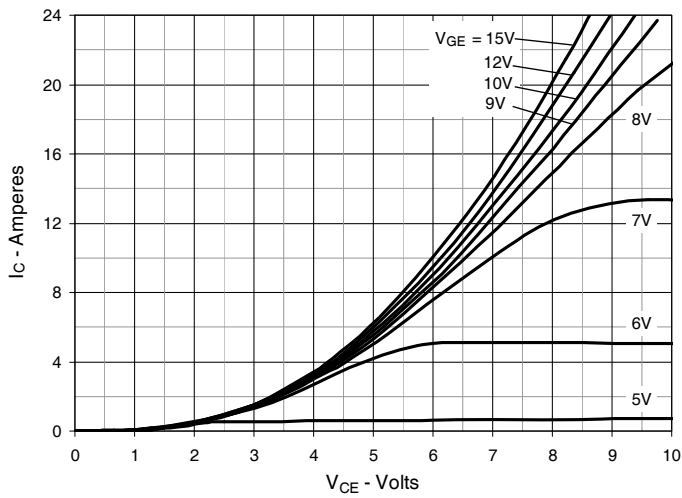

Fig. 4. Dependence of $V_{CE(sat)}$ on Junction Temperature

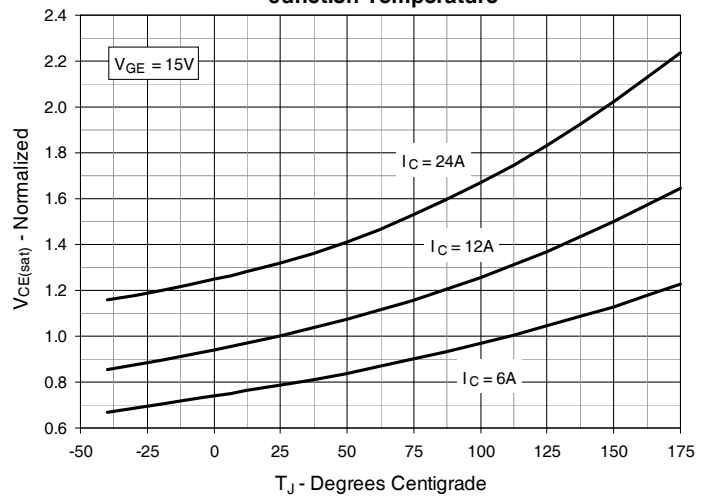

Fig. 5. Collector-to-Emitter Voltage vs. Gate-to-Emitter Voltage

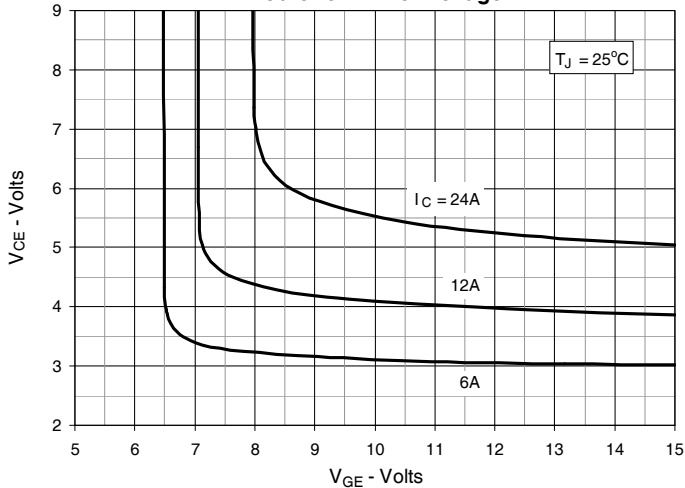

Fig. 6. Input Admittance

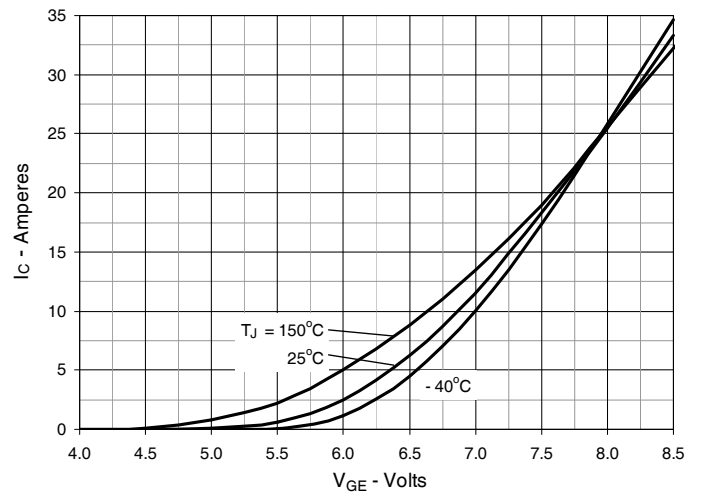

Fig. 7. Transconductance

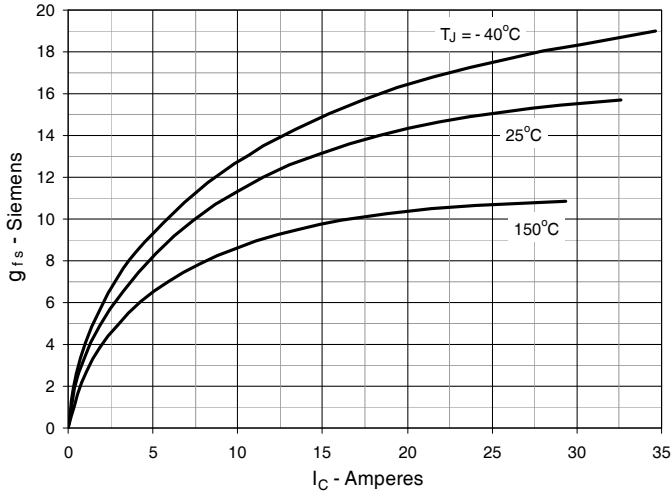

Fig. 8. Gate Charge

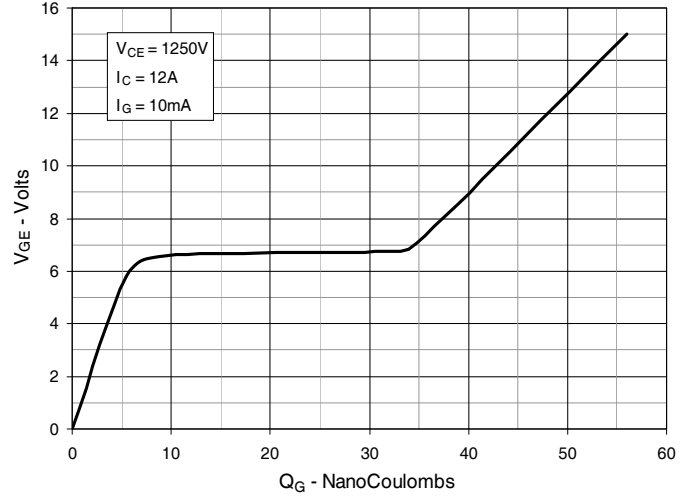

Fig. 9. Capacitance

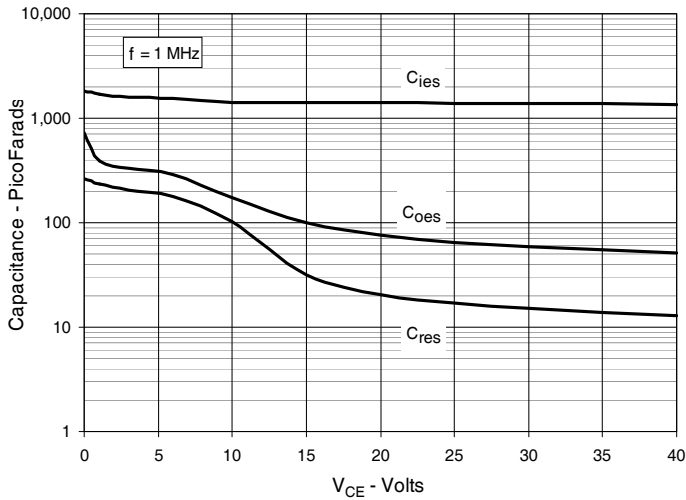

Fig. 10. Reverse-Bias Safe Operating Area

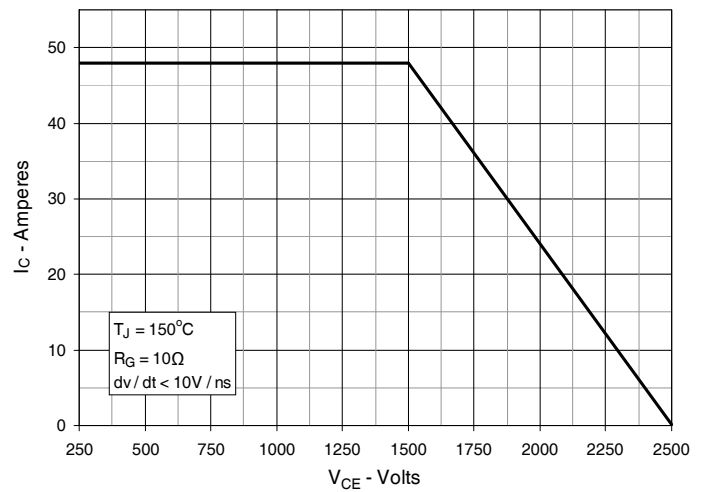

Fig. 11. Maximum Transient Thermal Impedance (IGBT)

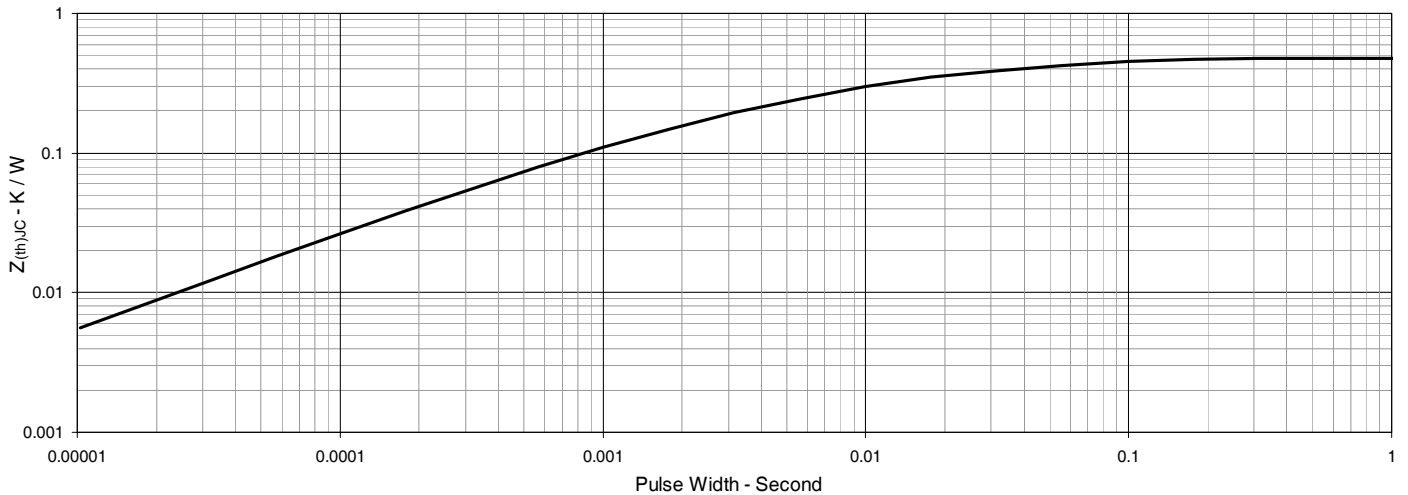

Fig. 12. Inductive Switching Energy Loss vs. Gate Resistance

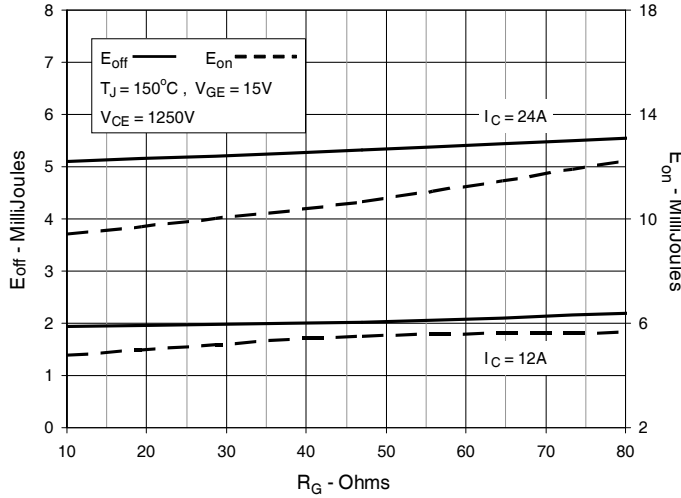

Fig. 13. Inductive Switching Energy Loss vs. Collector Current

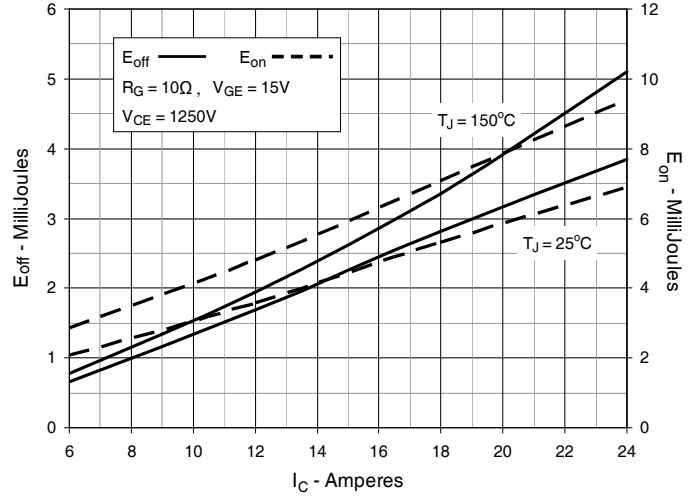

Fig. 14. Inductive Switching Energy Loss vs. Junction Temperature

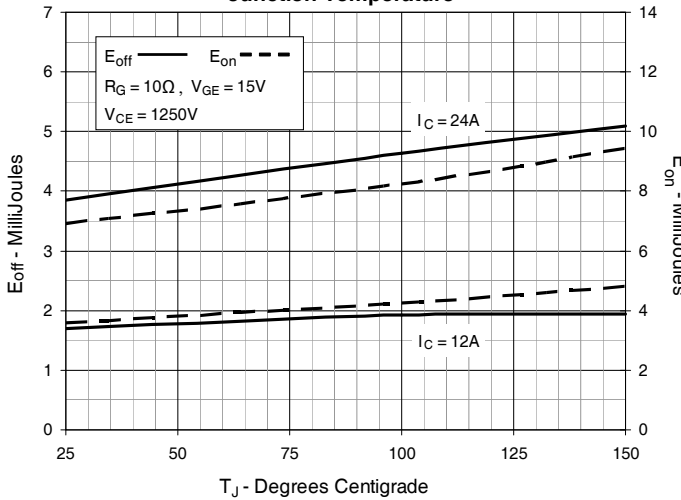

Fig. 15. Inductive Turn-off Switching Times vs. Gate Resistance

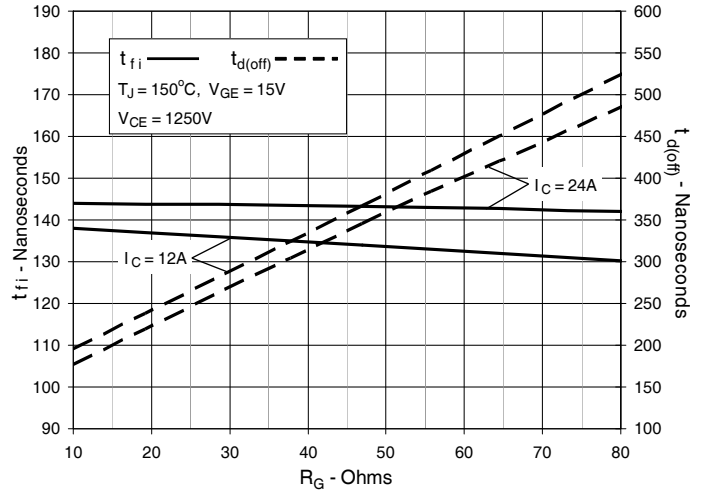

Fig. 16. Inductive Turn-off Switching Times vs. Collector Current

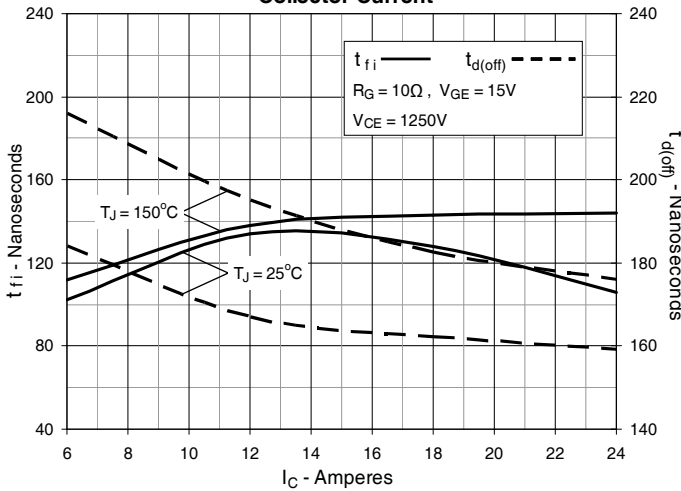

Fig. 17. Inductive Turn-off Switching Times vs. Junction Temperature

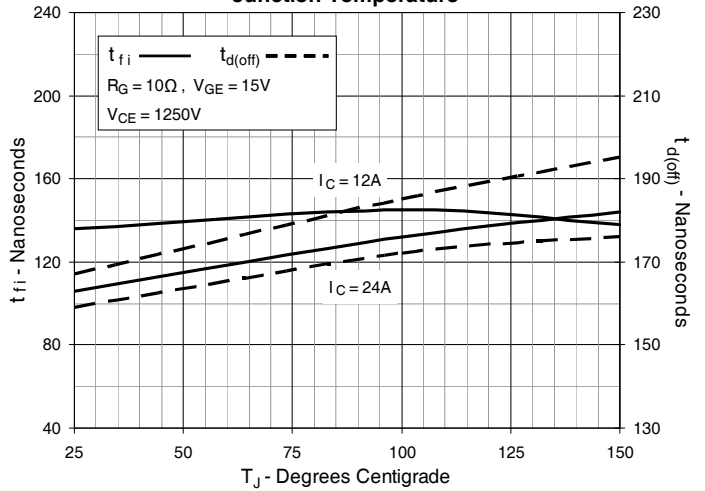

Fig. 18. Inductive Turn-on Switching Times vs. Gate Resistance

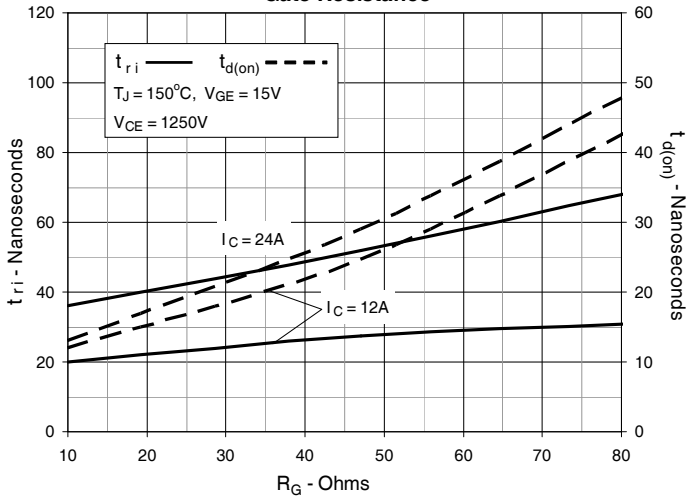

Fig. 19. Inductive Turn-on Switching Times vs. Collector Current

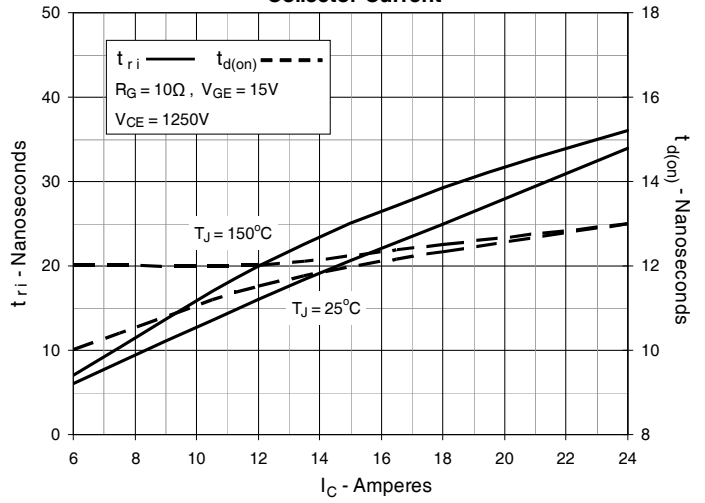

Fig. 20. Inductive Turn-on Switching Times vs. Junction Temperature

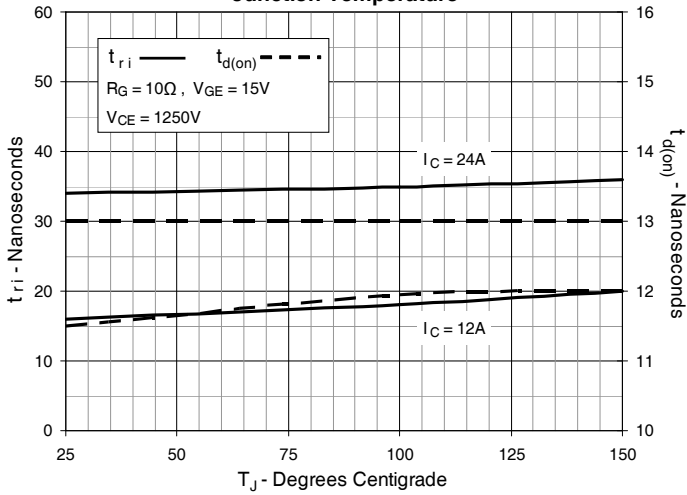

Fig. 21. Diode Forward Characteristics

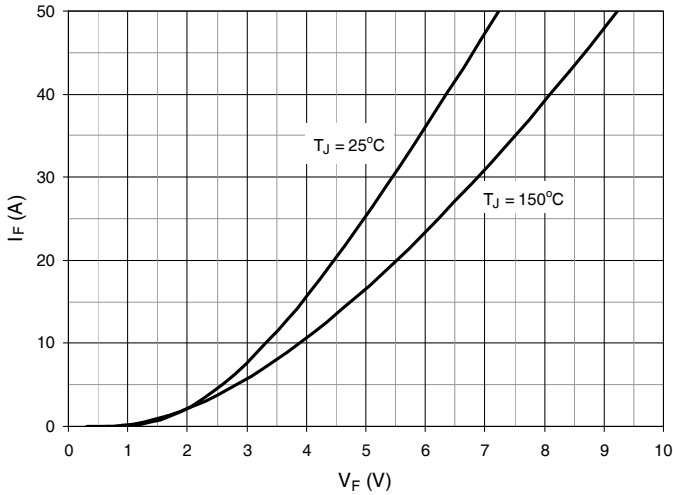

Fig. 22. Reverse Recovery Charge vs. $-di_F/dt$

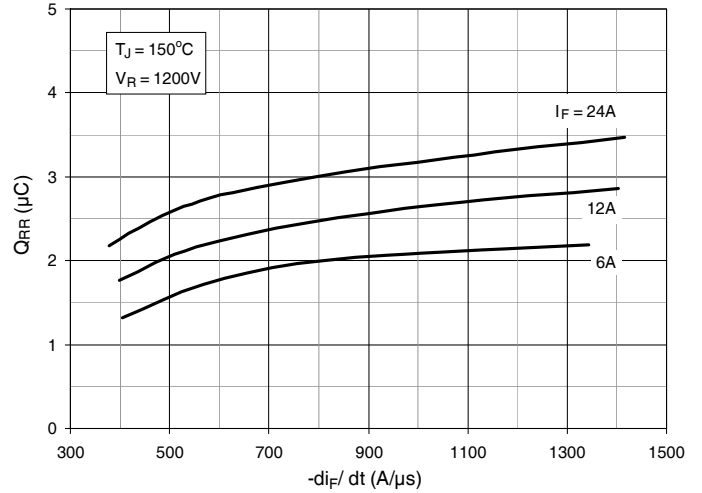

Fig. 23. Reverse Recovery Current vs. $-di_F/dt$

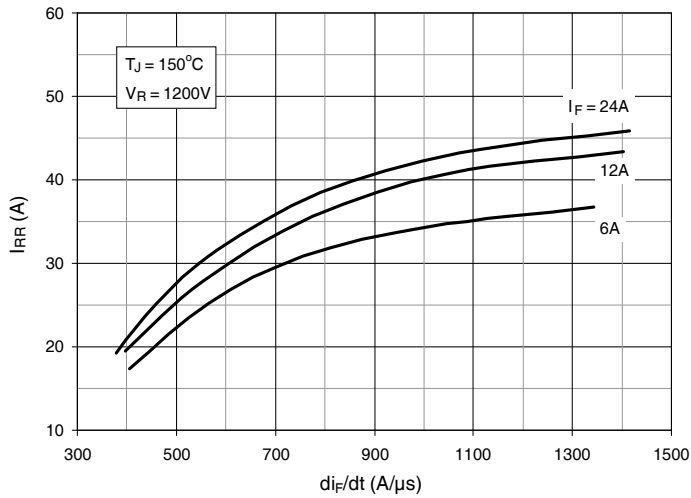

Fig. 24. Reverse Recovery Time vs. $-di_F/dt$

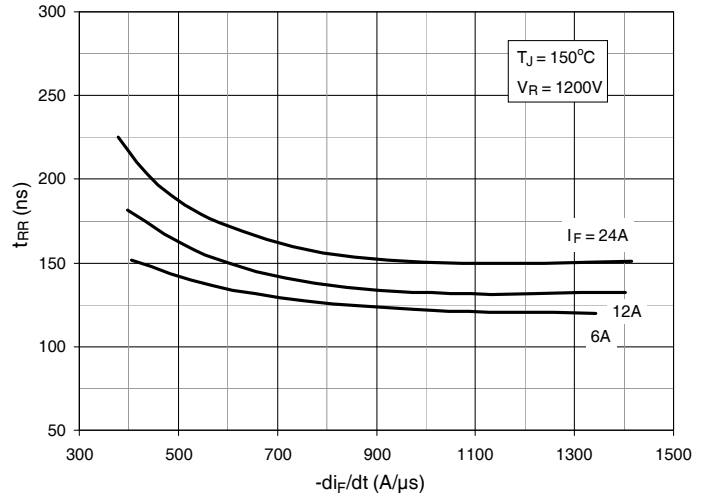

Fig. 25. Dynamic Parameters Q_{RR} , I_{RR} vs. Junction Temperature

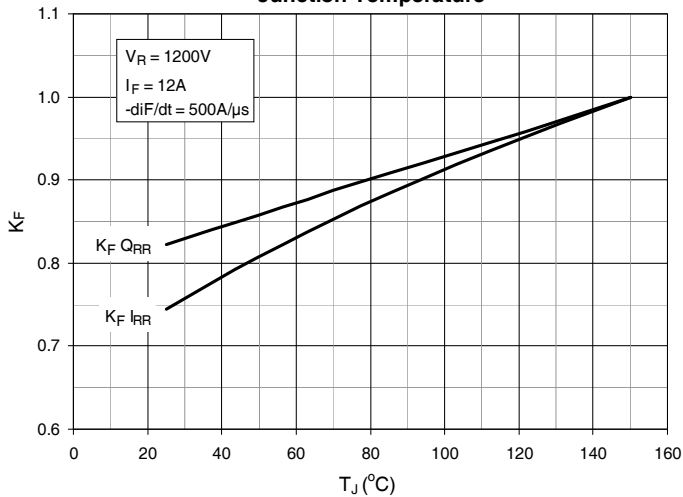
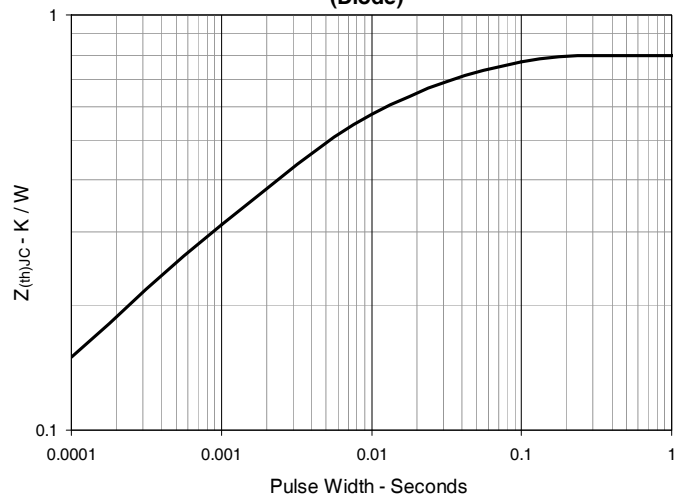

Fig. 26. Maximum Transient Thermal Impedance (Diode)





Disclaimer Notice - Information furnished is believed to be accurate and reliable. However, users should independently evaluate the suitability of and test each product selected for their own applications. Littelfuse products are not designed for, and may not be used in, all applications. Read complete Disclaimer Notice at www.littelfuse.com/disclaimer-electronics.