

IGBT Trench Module

$V_{CES} = 1700\text{ V}$
 $I_{C25} = 400\text{ A}$
 $V_{CE(sat)} = 2\text{ V}$

Boost/Brake Chopper + free wheeling Diode + NTC

Part number

MITA300RF1700PTED

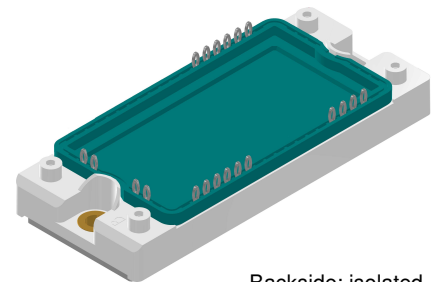

Backside: isolated

E72873

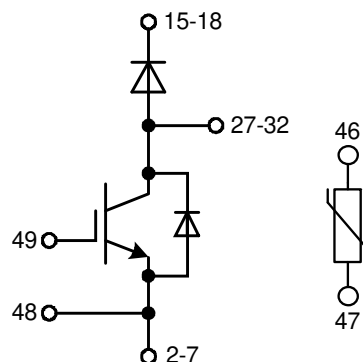

Features / Advantages:

- Brake with Infineon IGBT³

Applications:

- AC motor drives
- Solar inverter
- Medical equipment
- Uninterruptible power supply
- Air-conditioning systems
- Welding equipment
- Switched-mode and resonant-mode power supplies
- Inductive heating, cookers
- Pumps, Fans

Package: E2-Pack

- Isolation Voltage: 3600 V~
- Industry standard outline
- RoHS compliant
- PressFit-Pins for PCB mounting
- Height: 17 mm
- Base plate: Copper internally DCB isolated
- Advanced power cycling
- Phase Change Material available

Terms and Conditions of Usage

The data contained in this product data sheet is exclusively intended for technically trained staff. The user will have to evaluate the suitability of the product for the intended application and the completeness of the product data with respect to his application. The specifications of our components may not be considered as an assurance of component characteristics. The information in the valid application- and assembly notes must be considered. Should you require product information in excess of the data given in this product data sheet or which concerns the specific application of your product, please contact your local sales office.

Due to technical requirements our product may contain dangerous substances. For information on the types in question please contact your local sales office.

Should you intend to use the product in aviation, in health or life endangering or life support applications, please notify. For any such application we urgently recommend

- to perform joint risk and quality assessments;

- the conclusion of quality agreements;

- to establish joint measures of an ongoing product survey, and that we may make delivery dependent on the realization of any such measures.

| Free Wheeling Diode FWD | | | | Ratings | | | |
|-------------------------|----------------------------------------------|--------------------------------------------------------------------|------------------------------|---------|------|---------------|---|
| Symbol | Definition | Conditions | min. | typ. | max. | Unit | |
| V_{RSM} | max. non-repetitive reverse blocking voltage | | | | 1700 | V | |
| V_{RRM} | max. repetitive reverse blocking voltage | | | | 1700 | V | |
| I_R | reverse current, drain current | $V_R = 1700\text{ V}$ | | | 100 | μA | |
| | * not applicable, see Ices at IGBT | $V_R = 1700\text{ V}$ | | | 0.8 | mA | |
| V_F | forward voltage drop | $I_F = 40\text{ A}$ | | | 2.20 | V | |
| | | $I_F = 80\text{ A}$ | | | 2.75 | V | |
| | | $I_F = 40\text{ A}$ | $T_{VJ} = 125^\circ\text{C}$ | | | 2.30 | V |
| | | $I_F = 80\text{ A}$ | | | | 3.15 | V |
| I_{FAV} | average forward current | $T_C = 80^\circ\text{C}$ rectangular $d = 0.5$ | | | 40 | A | |
| V_{F0} | threshold voltage | } for power loss calculation only | | | 1.35 | V | |
| r_F | slope resistance | | | | 23 | m Ω | |
| R_{thJC} | thermal resistance junction to case | | | | 1 | K/W | |
| R_{thCH} | thermal resistance case to heatsink | | | 0.30 | | K/W | |
| P_{tot} | total power dissipation | | | | 125 | W | |
| I_{FSM} | max. forward surge current | $t = 10\text{ ms}; (50\text{ Hz}), \text{ sine}; V_R = 0\text{ V}$ | | | 300 | A | |
| C_J | junction capacitance | $V_R = 900\text{ V}$ $f = 1\text{ MHz}$ | | | 14 | pF | |

| Boost IGBT | | | | Ratings | | | |
|-----------------------|--------------------------------------|------------------------------------------------------------------------------|------|---------|------|------|--|
| Symbol | Definition | Conditions | min. | typ. | max. | Unit | |
| V_{CES} | collector emitter voltage | | | | 1700 | V | |
| V_{GES} | max. DC gate voltage | | | | ±20 | V | |
| V_{GEM} | max. transient gate emitter voltage | | | | ±30 | V | |
| I_{C25} | collector current | | | | 400 | A | |
| I_{C80} | | | | | 280 | A | |
| P_{tot} | total power dissipation | | | | 1390 | W | |
| $V_{CE(sat)}$ | collector emitter saturation voltage | $I_C = 300A; V_{GE} = 15V$ | | | 2 | V | |
| | | | | | 2.4 | V | |
| $V_{GE(th)}$ | gate emitter threshold voltage | $I_C = 12mA; V_{GE} = V_{CE}$ | 5.2 | 5.8 | 6.4 | V | |
| I_{CES} | collector emitter leakage current | $V_{CE} = V_{CES}; V_{GE} = 0V$ | | | 1.2 | mA | |
| | | | | | 1.4 | mA | |
| I_{GES} | gate emitter leakage current | $V_{GE} = ±20V$ | | | 800 | nA | |
| $Q_{G(on)}$ | total gate charge | $V_{CE} = 900V; V_{GE} = 15V; I_C = 300A$ | | 3400 | | nC | |
| $t_{d(on)}$ | turn-on delay time | inductive load $V_{CE} = 900V; I_C = 300A$ $V_{GE} = ±15V; R_G = 4.7Ω$ | | 340 | | ns | |
| t_r | current rise time | | | 90 | | ns | |
| $t_{d(off)}$ | turn-off delay time | | | 800 | | ns | |
| t_f | current fall time | | | 400 | | ns | |
| E_{on} | turn-on energy per pulse | | | 100 | | mJ | |
| E_{off} | turn-off energy per pulse | | | 75 | | mJ | |
| RBSOA | reverse bias safe operating area | $V_{GE} = ±15V; R_G = 4.7Ω$ | | | | | |
| I_{CM} | | $V_{CEmax} = 1700V$ | | | 600 | A | |
| SCSOA | short circuit safe operating area | $V_{CEmax} = 1700V$ | | | | | |
| t_{SC} | short circuit duration | $V_{CE} = 900V; V_{GE} = ±15V$ | | | 10 | μs | |
| I_{SC} | short circuit current | $R_G = 4.7Ω; \text{non-repetitive}$ | | 1600 | | A | |
| R_{thJC} | thermal resistance junction to case | | | | 0.09 | K/W | |
| R_{thCH} | thermal resistance case to heatsink | | | | 0.03 | K/W | |
| Boost Diode BD | | | | | | | |
| V_{RRM} | max. repetitive reverse voltage | | | | 1700 | V | |
| I_{F25} | forward current | | | | 400 | A | |
| I_{F80} | | | | | 300 | A | |
| V_F | forward voltage | $I_F = 300A$ | | | 2.20 | V | |
| | | | | | 2.00 | V | |
| I_R | reverse current | $V_R = V_{RRM}$ | | | 1.2 | mA | |
| | | | | | 1.2 | mA | |
| Q_{rr} | reverse recovery charge | $V_R = 900V$ $-di_F/dt = 3000A/μs$ $I_F = 300A; V_{GE} = 0V$ | | 80 | | μC | |
| I_{RM} | max. reverse recovery current | | | 300 | | A | |
| t_{rr} | reverse recovery time | | | 950 | | ns | |
| E_{rec} | reverse recovery energy | | | 40 | | mJ | |
| R_{thJC} | thermal resistance junction to case | | | | 0.14 | K/W | |
| R_{thCH} | thermal resistance case to heatsink | | | | 0.05 | K/W | |

| Package E2-Pack | | Ratings | | | | |
|-----------------|--------------------------------------------------------------|-----------------------------------------------------------------------------|------|------|------|------|
| Symbol | Definition | Conditions | min. | typ. | max. | Unit |
| I_{RMS} | RMS current | per terminal | | | 30 | A |
| T_{VJ} | virtual junction temperature | | -40 | | 150 | °C |
| T_{op} | operation temperature | | -40 | | 125 | °C |
| T_{stg} | storage temperature | | -40 | | 125 | °C |
| Weight | | | | 176 | | g |
| M_D | mounting torque | | 3 | | 6 | Nm |
| $d_{Spp/App}$ | creepage distance on surface / striking distance through air | terminal to terminal | 6.0 | | | mm |
| $d_{Spb/Apb}$ | | terminal to backside | 12.0 | | | mm |
| V_{ISOL} | isolation voltage | t = 1 second 50/60 Hz, RMS; $I_{ISOL} \leq 1$ mA t = 1 minute | 3600 | | | V |
| | | | 3000 | | | V |
| $R_{pin-chip}$ | resistance pin to chip | $V = V_{CEsat} + 2 \cdot R \cdot I_C$ resp. $V = V_F + 2 \cdot R \cdot I_F$ | | 2.5 | | mΩ |

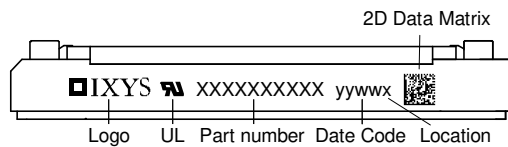

Part description

- M = Module
- I = IGBT
- T = IGBT Trench
- A = Gen 3 / std
- 300 = Current Rating [A]
- RF = Boost/Brake Chopper + free wheeling Diode
- 1700 = Reverse Voltage [V]
- PT = PressFit-Pin, Thermistor
- ED = E2-Pack
- = Hyphen
- PC = Phase Change Material

| Ordering | Ordering Number | Marking on Product | Delivery Mode | Quantity | Code No. |
|-------------|----------------------|--------------------|---------------|----------|----------|
| Standard | MITA300RF1700PTED | MITA300RF1700PTED | Blister | 28 | 516670 |
| Alternative | MITA300RF1700PTED-PC | MITA300RF1700PTED | Blister | 28 | 515402 |

Temperature Sensor NTC

| Symbol | Definition | Conditions | min. | typ. | max. | Unit |
|-------------|-------------------------|---------------------|------|------|------|------|
| R_{25} | resistance | $T_{VJ} = 25^\circ$ | 4.85 | 5 | 5.15 | kΩ |
| $B_{25/50}$ | temperature coefficient | | | 3375 | | K |

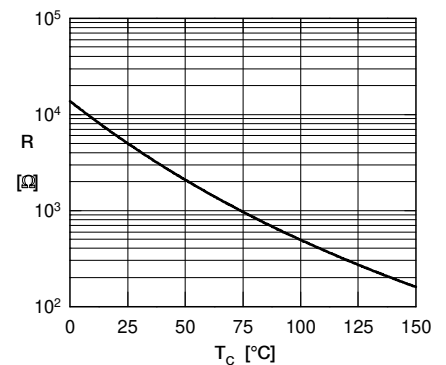

Outlines E2-Pack

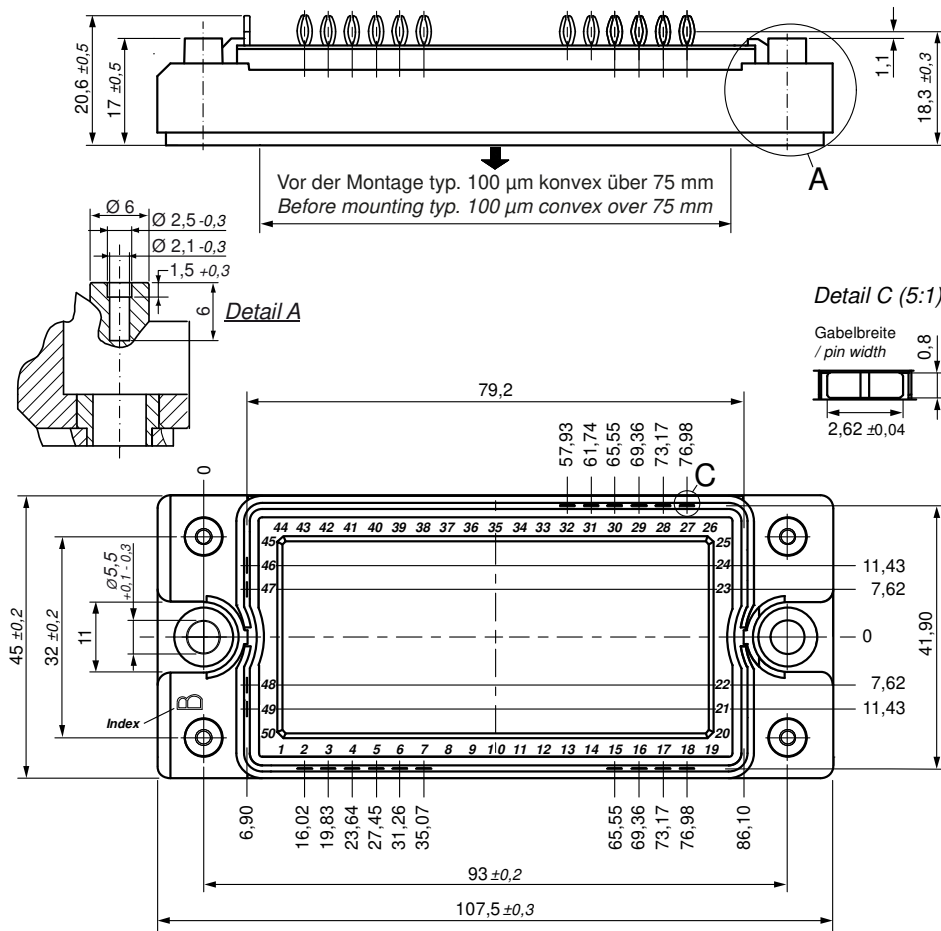

Bemerkung / Note:

- Nicht tolerierte Maße nach / Measure without tolerances according DIN ISO 2768-T1-m
- PCB-Lochmuster / PCB hole pattern: **see pin position**
- Toleranz Pin-Position und PCB-Lochmuster / Tolerance of pin position and PCB hole pattern: $\oplus 0.1$
- Bohrlochdurchmesser / Diameter of drill: **Ø 2.35 mm**
- Endlochdurchmesser / Diameter of plated holes: **Ø 2.14 - 2.29 mm** (Cu thickness in via typ. 50 µm)
- Beschichtung / Plating: **chem. Sn max. 15 µm**
- Einpresskraft / Insert Force: per terminal with a typ. insert speed of 7 mm/s: **typ. 90 N**
- Weitere Angaben / Further information: www.ixys.com **Application note IXAN0077**
- Montageanleitung / Mounting instruction: www.ixys.com **Application note IXAN0024**

Detail A: PCB-Montage / Mounting on PCB^L

- Empfohlene, selbstschneidende Schraube / Recommended, self-tapping screw: **EJOT PT®** (Größe / size: **K25**)^L
- Max. Schraubenlänge / Max. screw length: **PCB-Dicke / thickness + 6 mm** (max. Lochtiefe / hole depth)^L
- Empfohlenes Drehmoment / Recommended mounting torque: **1.5 Nm**

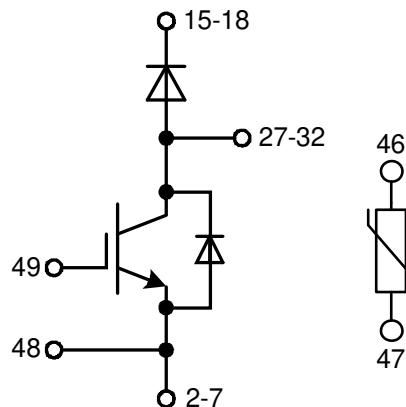

Boost IGBT

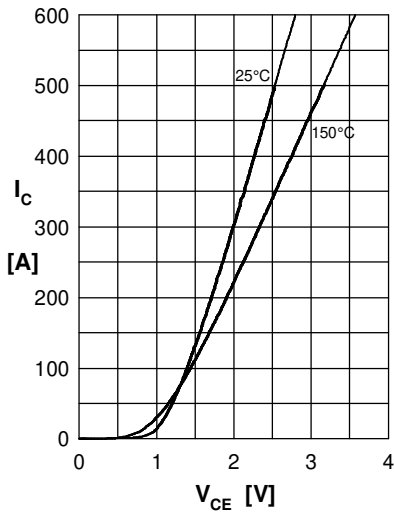

Fig. 1 Typ. output characteristics IGBT

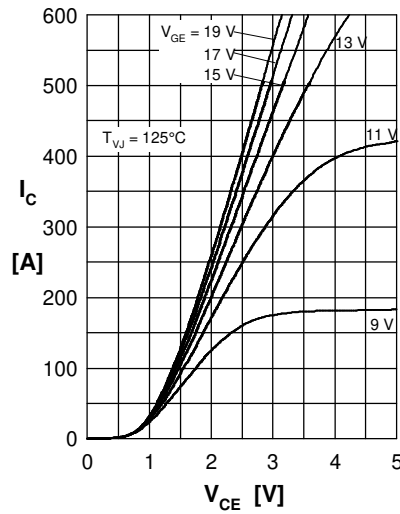

Fig. 2 Typ. output characteristics IGBT

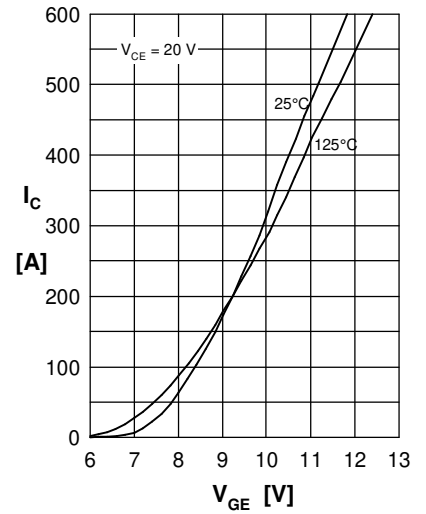

Fig. 3 Typ. transfer charact. IGBT

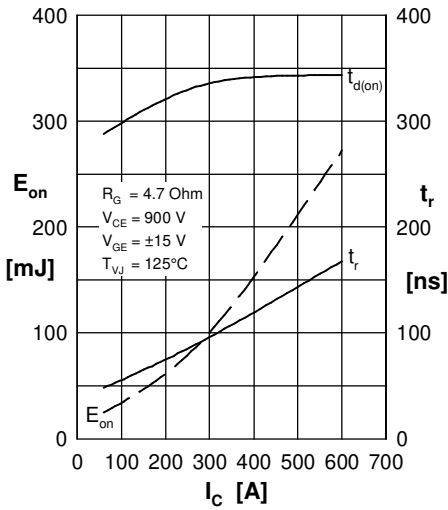

Fig. 4 Typ. turn-on energy & switch times vs. collector current

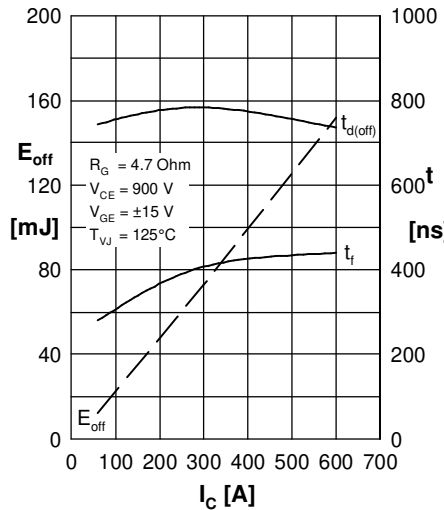

Fig. 5 Typ. turn-off energy & switch times vs. collector current

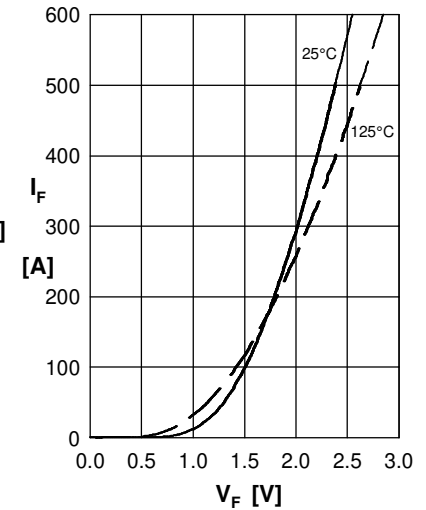

Fig. 6 Typ. forward characteristics Diode

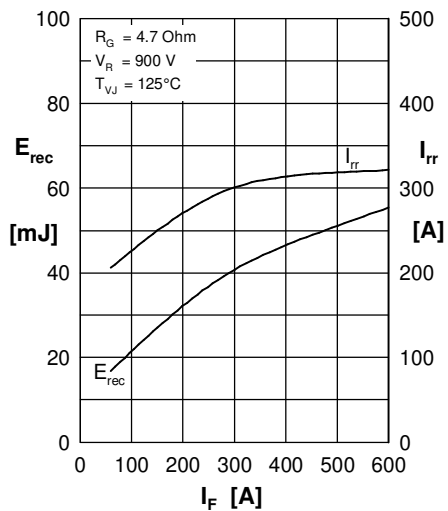

Fig. 7 Typ. reverse recovery characteristics Diode

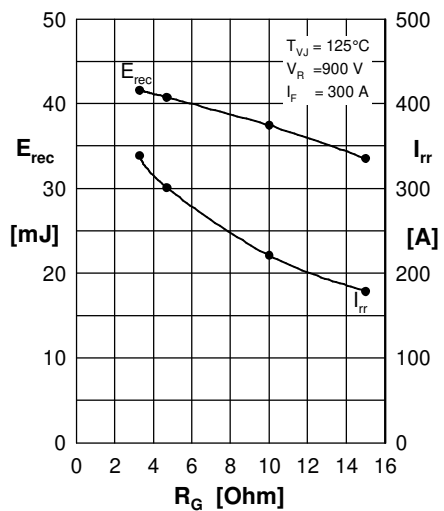

Fig. 8 Typ. reverse recovery characteristics Diode

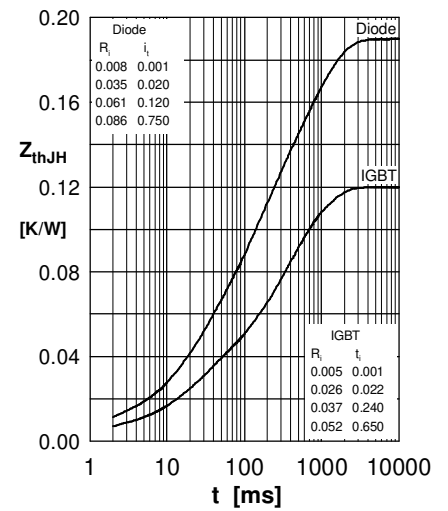

Fig. 9 Typ. transient thermal resistance junction to heatsink