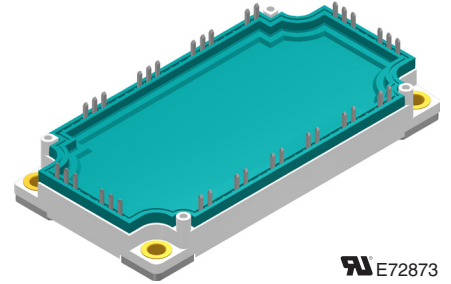



X2PT IGBT Module

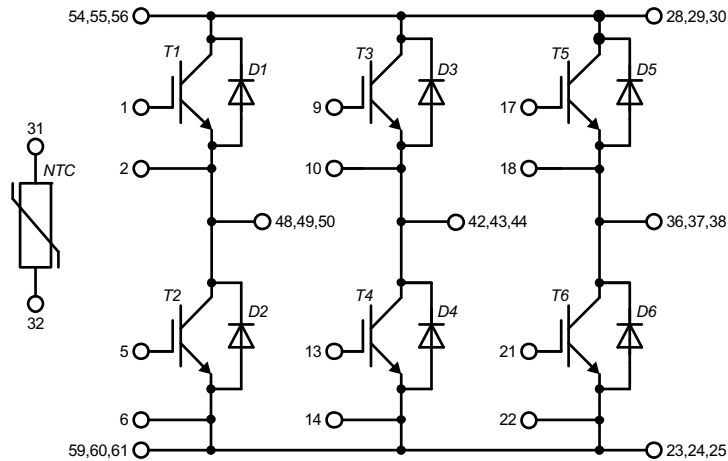
$V_{CES} = 1200 \text{ V}$
 $I_{C25} = 186 \text{ A}$
 $V_{CE(sat)} = 1.7 \text{ V}$

6-Pack + NTC

Part number
 MIXG120W1200TEH



 E72873



Features / Advantages:

- X2PT - 2nd generation Xtreme light Punch Through
- $T_{vjm} = 175^\circ\text{C}$
- Easy paralleling due to the positive temperature coefficient of the on-state voltage
- Rugged X2PT design results in:
 - short circuit rated for 10 μsec .
 - very low gate charge
 - low EMI
 - square RBSOA @ 2x I_c
- Low $V_{CE(sat)}$ and low thermal resistance
- SONIC™ diode
 - fast and soft reverse recovery
 - low operating forward voltage

Applications:

- AC motor drives
- Solar inverter
- Medical equipment
- Uninterruptible power supply
- Air-conditioning systems
- Welding equipment
- Switched-mode and resonant-mode power supplies
- Inductive heating, cookers
- Pumps, Fans

Package: E3-Pack

- Isolation Voltage: 3600 V~
- Industry standard outline
- RoHS compliant
- Base plate: Copper internally DCB isolated
- Advanced power cycling

Option:

- Phase Change Material printed on base plate

Disclaimer Notice

Information furnished is believed to be accurate and reliable. However, users should independently evaluate the suitability of and test each product selected for their own applications. Littelfuse products are not designed for, and may not be used in, all applications. Read complete Disclaimer Notice Disclaimer Notice at www.littelfuse.com/disclaimer-electronics.



Inverter IGBT				Ratings		
Symbol	Definitions	Conditions	min.	typ.	max.	
V_{CES}	collector emitter voltage	$T_{VJ} = 25^{\circ}\text{C}$			1200	V
V_{GES}	max. DC gate voltage		-20		+20	V
V_{GEM}	max. transient gate emitter voltage		-30		+30	V
I_{C25}	collector current	$T_C = 25^{\circ}\text{C}$			186	A
I_{C80}		$T_C = 80^{\circ}\text{C}$			140	A
I_{C100}		$T_C = 100^{\circ}\text{C}$			120	A
P_{tot}	total power dissipation	$T_C = 25^{\circ}\text{C}$			625	W
$V_{CE(sat)}$	collector emitter saturation voltage	$I_C = 100\text{ A}; V_{GE} = 15\text{ V}$		1.7 2.0	2.0	V V
$V_{GE(th)}$	gate emitter threshold voltage	$I_C = 4\text{ mA}; V_{GE} = V_{GE}$	6		7	V
I_{CES}	collector emitter leakage current	$V_{CE} = V_{CES}; V_{GE} = 0\text{ V}$		2		mA mA
I_{GES}	gate emitter leakage current	$V_{GE} = \pm 20\text{ V}$			500	nA
R_G	internal gate resistance			3.9		Ω
C_{iss}	input capacitance	$V_{CE} = 100\text{ V}; V_{GS} = 0\text{ V}; f = 1\text{ MHz}$		5.8		nF
C_{oss}	output capacitance					pF
C_{rss}	reverse transfer (Miller) capacitance					pF
Q_g	total gate charge	$V_{CE} = 600\text{ V}; V_{GE} = 0/15\text{ V}; I_C = 100\text{ A}$		340		nC
Q_{gs}	gate source charge					nC
Q_{gd}	gate drain (Miller) charge					nC
$t_{d(on)}$	turn-on delay time	Inductive switching $V_{CE} = 600\text{ V}; I_C = 100\text{ A}$ $V_{GE} = \pm 15\text{ V}; R_G = 6.8\ \Omega$ (external) $T_{VJ} = 25^{\circ}\text{C}$		140		ns
t_r	current rise time			50		ns
$t_{d(off)}$	turn-off delay time			260		ns
t_f	current fall time			170		ns
E_{on}	turn-on energy per pulse			7.5		mJ
E_{off}	turn-off energy per pulse			8.4		mJ
$E_{rec(off)}$	reverse recovery losses at turn-off		3.3		mJ	
$t_{d(on)}$	turn-on delay time	Inductive switching $V_{CE} = 600\text{ V}; I_C = 100\text{ A}$ $V_{GE} = \pm 15\text{ V}; R_G = 6.8\ \Omega$ (external) $T_{VJ} = 150^{\circ}\text{C}$		145		ns
t_r	current rise time			58		ns
$t_{d(off)}$	turn-off delay time			330		ns
t_f	current fall time			275		ns
E_{on}	turn-on energy per pulse			10.9		mJ
E_{off}	turn-off energy per pulse			12.0		mJ
$E_{rec(off)}$	reverse recovery losses at turn-off		6.7		mJ	
RBSOA	reverse bias safe operating area	$V_{GE} = \pm 15\text{ V}; R_G = 6.8\ \Omega$ $V_{CEmax} = 1200\text{ V}$			200	A
SCSOA	short circuit safe operating area	$V_{CEmax} = 1200\text{ V}$ $V_{CE} = 800\text{ V}; V_{GE} = \pm 15\text{ V}$ non-repetitive			10	μs
t_{sc}	short circuit duration		400			A
I_{sc}	short circuit current					
R_{thJC}	thermal resistance junction to case			0.3	0.24	K/W
R_{thJH}	thermal resistance junction to heatsink	with heatsink compound; IXYS test setup				K/W

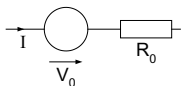
Inverter Diode				Ratings		
Symbol	Definitions	Conditions	min.	typ.	max.	
V_{RRM}	max. repetitive reverse voltage				1200	V
I_{F25}	forward current				161	A
I_{F80}					117	A
I_{F100}					100	A
V_F	forward voltage	$I_F = 100$ A		1.7	2.0	V
				1.7		V
I_R	reverse current * not applicable, see Ices at IGBT	$V_R = V_{RRM}$		*	*	mA mA
Q_{RM}	reverse recovery charge	Inductive switching $V_{CE} = 600$ V; $I_C = 100$ A IGBT gate drive: $V_{GE} = \pm 15$ V; $R_G = 6.8$ Ω (external)		8.2		μ C
I_{RM}	max. reverse recovery current		$T_{VJ} = 25^\circ\text{C}$	65		A
t_{rr}	reverse recovery time			400		ns
dI_F/dt	current slew rate			2190		A/ μ s
Q_{RM}	reverse recovery charge	Inductive switching $V_{CE} = 600$ V; $I_C = 100$ A IGBT gate drive: $V_{GE} = \pm 15$ V; $R_G = 6.8$ Ω (external)		16.4		μ C
I_{RM}	max. reverse recovery current		$T_{VJ} = 150^\circ\text{C}$	84		A
t_{rr}	reverse recovery time			520		ns
dI_F/dt	current slew rate			1840		A/ μ s
R_{thJC}	thermal resistance junction to case				0.4	K/W
R_{thJH}	thermal resistance junction to heatsink	with heatsink compound; IXYS test setup		0.5		K/W

Temperature Sensor NTC

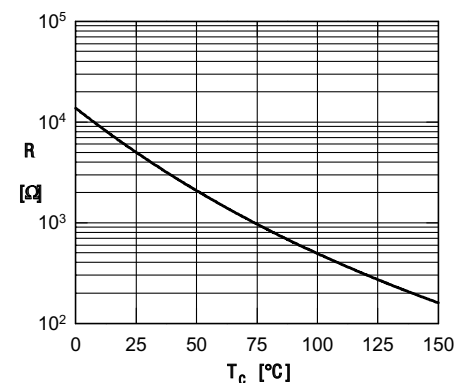
Symbol	Definitions	Conditions	min.	typ.	max.	Unit
R_{25}	resistance	$T_C = 25^\circ\text{C}$	4.75	5.0	5.25	k Ω
$B_{25/50}$	temperature coefficient			3375		K

Equivalent Circuits for Simulation

* on die level

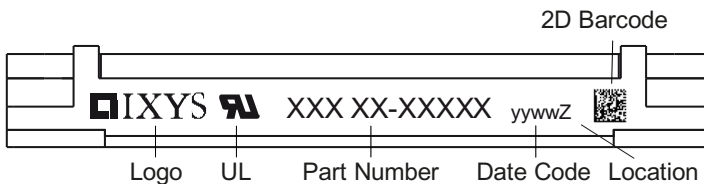

IGBT
Diode

V_0	threshold voltage	$T_{VJ} =$				V
R_0	slope resistance *	125 $^\circ\text{C}$				m Ω
V_0	threshold voltage	$T_{VJ} =$	1.2	1.2		V
R_0	slope resistance *	175 $^\circ\text{C}$	11.6	7		m Ω



Typ. NTC resistance vs. temperature

Package E3-Pack			Ratings			
Symbol	Definitions	Conditions	min.	typ.	max.	Unit
I_{RMS}	RMS current	per terminal		50		A
T_{stg}	storage temperature		-40		125	°C
T_{op}	operation temperature		-40		150	°C
T_{vJ}	virtual junction temperature		-40		175	°C
Weight				305		g
M_D	mounting torque		3		6	Nm
d_{Spp}	creepage distance on surface	terminal to terminal	6			mm
d_{Spb}		terminal to backside	12			mm
d_{App}	striking distance through air	terminal to terminal	6			mm
d_{Appb}		terminal to backside	12			mm
V_{ISOL}	isolation voltage	50/60 Hz, RMS; $I_{ISOL} \leq 1$ mA	$t = 1$ second $t = 1$ minute	4300 3600		V V
$R_{pin-chip}$	resistance pin to chip	$V = V_{CEsat} + 2 \cdot R \cdot I_C$ resp. $V = V_F + 2 \cdot R \cdot I_F$		2.3		mΩ

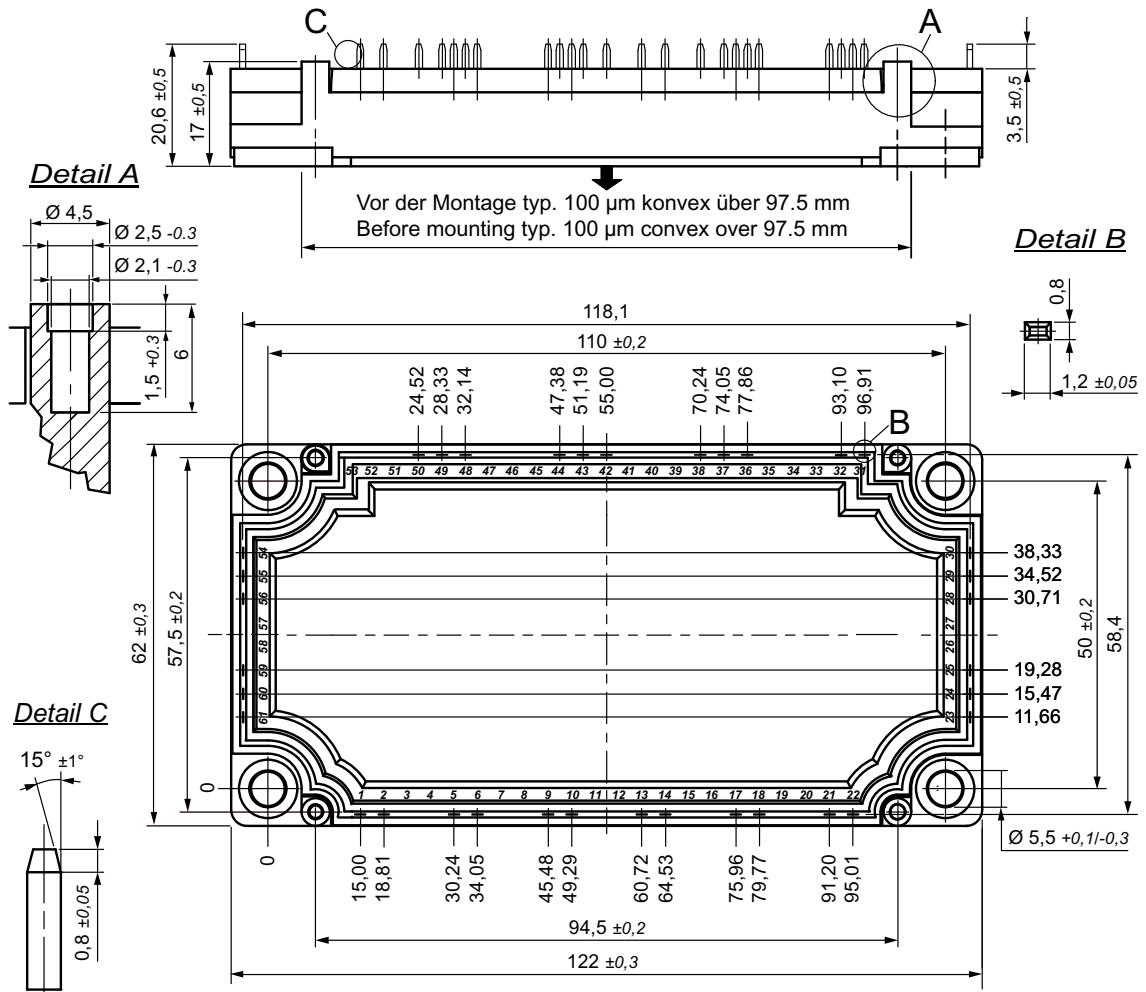

Part number

- M = Module
- I = IGBT
- X = XPT IGBT
- G = Gen 2 / std
- 120 = Current Rating [A]
- W = 6-pack
- 1200 = Reverse Voltage [V]
- T = Thermistor
- EH = E3-Pack
- = Hyphen
- PC = Phase Change Material

Ordering	Part Name	Marking on Product	Delivering Mode	Base Qty	Ordering Code
Standard	MIXG120W1200TEH	MIXG120W1200TEH	Box	5	MIXG120W1200TEH
with Phase Change Material	MIXG120W1200TEH-PC ¹⁾	MIXG120W1200TEH	Blister	24	

Similar Part	Package	Voltage class
MIXG120W1200PTEH ²⁾	E3- Pack, press fit pin	1200

Options: ¹⁾ phase change material and ²⁾ press fit pin
 Please contact Littelfuse - IXYS sales office for availability

Outlines E3-Pack

Bemerkung / Note:

- Nichttolerierete Maße nach / Measure without tolerances according DIN ISO 2768-T1-m

- PCB-Lochmuster / PCB hole pattern: **see pin position**

- Toleranz Pin-Position und PCB-Lochmuster / Tolerance of pin position and PCB hole pattern: $\oplus 0,1$

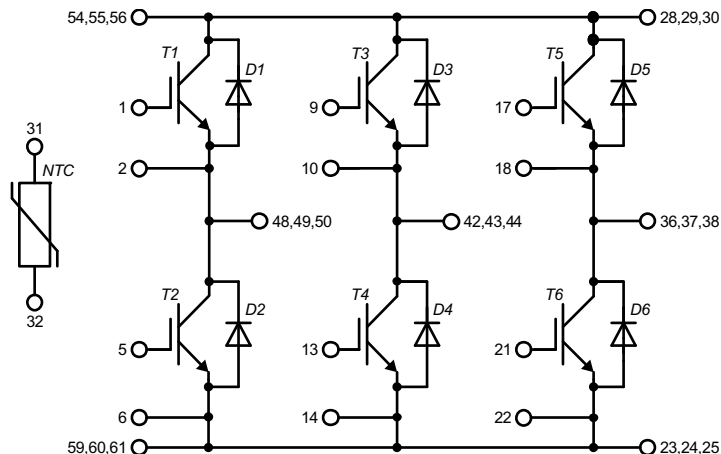
- Montageanleitung / Mounting instruction: www.ixys.com **Application note IXAN0024**

Detail A: PCB-Montage / Mounting on PCB

- Empfohlene, selbstschneidende Schraube / Recommended, self-tapping screw: **EJOT PT®** (Größe / size: **K25**)

- Max. Schraubenlänge / Max. screw length: **PCB-Dicke / thickness + 6 mm** (max. Lochtiefe / hole depth)

- Empfohlenes Drehmoment / Recommended mounting torque: **1.5 Nm**



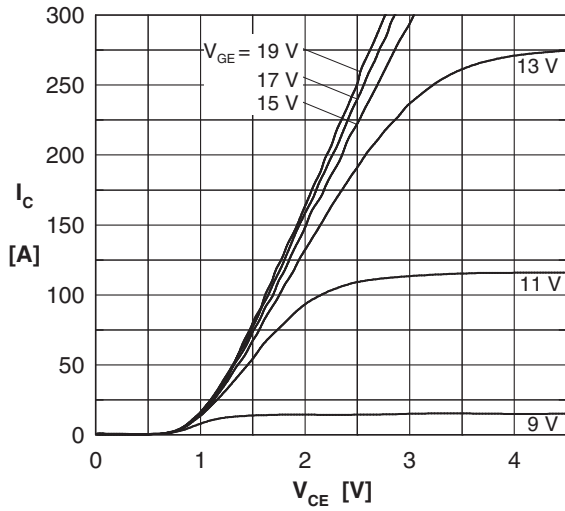
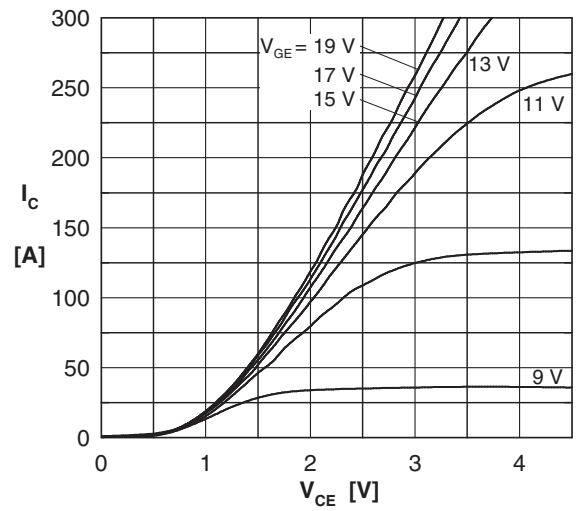
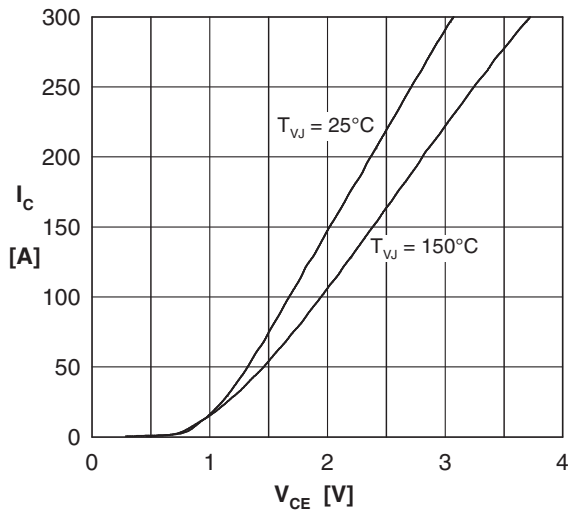
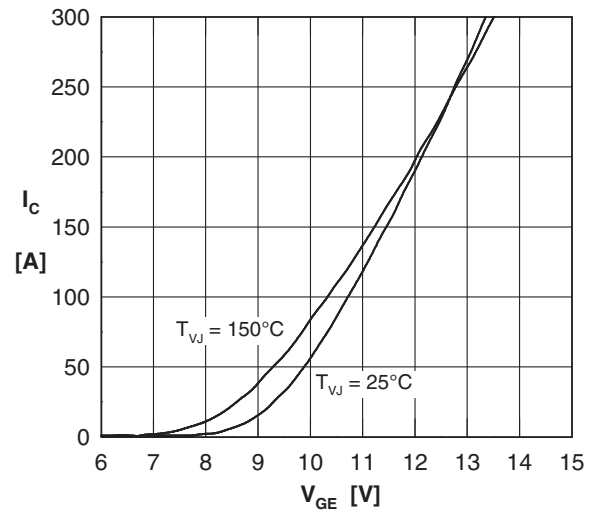
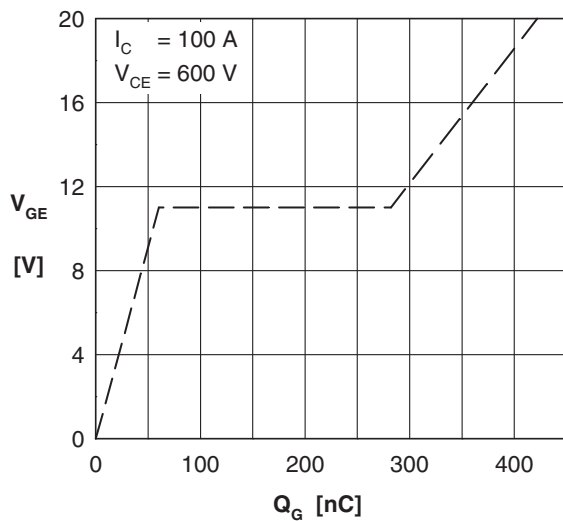
IGBTs T1 - T6

 Fig. 1 Typ. output characteristics ($T_{VJ} = 25^{\circ}\text{C}$)

 Fig. 2 Typ. output characteristics ($T_{VJ} = 150^{\circ}\text{C}$)

 Fig. 3 Typ. output characteristics ($V_{GE} = 15\text{V}$)

 Fig. 4 Typ. transfer characteristics ($V_{CE} = 20\text{V}$)


Fig. 5 Typ. turn-on gate charge 0/20V

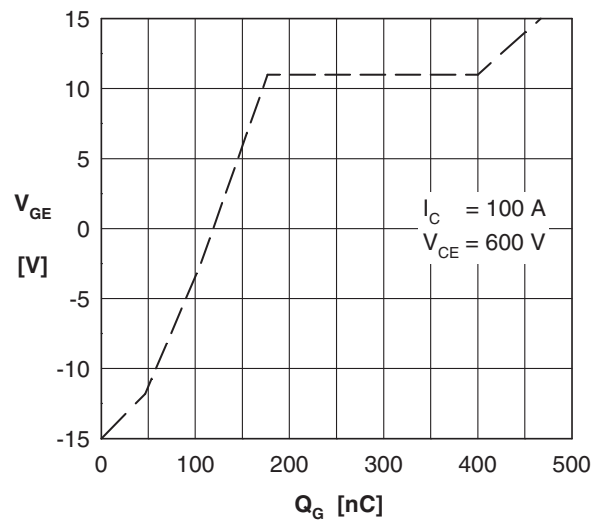


Fig. 6 Typ. turn-on gate charge -15/+15V

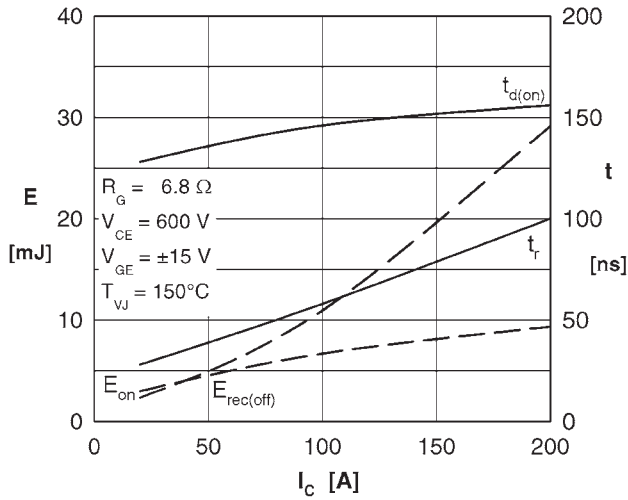
IGBTs T1 - T6


Fig. 7 Typ. switching energy versus collector current (turn on)

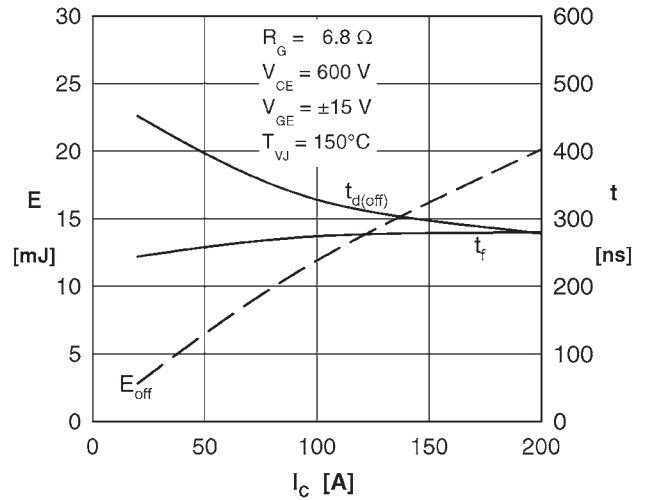


Fig. 8 Typ. switching energy versus collector current (turn off)

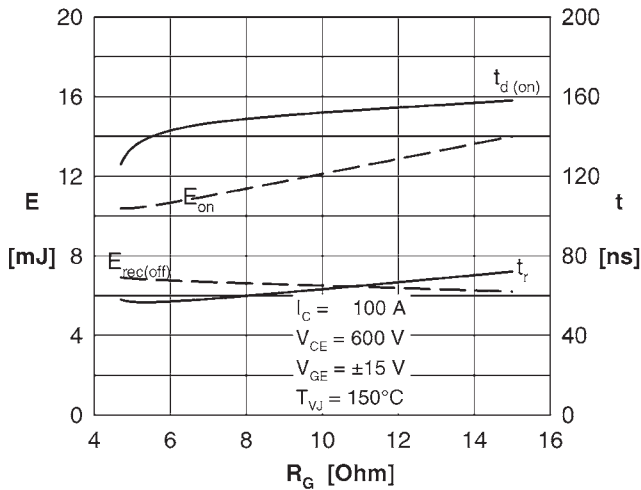


Fig. 9 Typ. switching energy versus gate resistor (turn on)

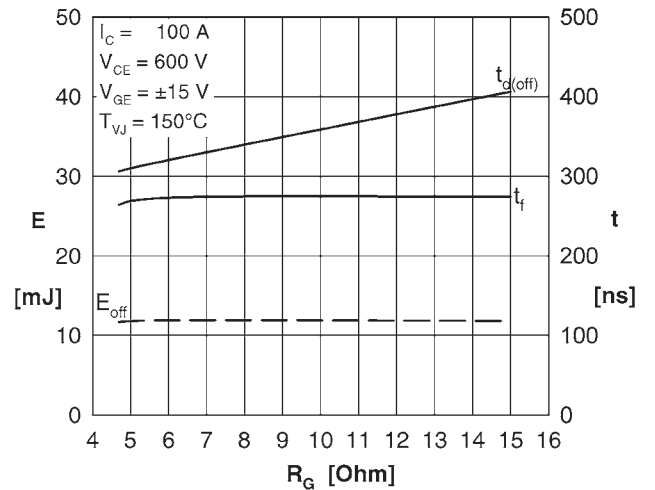


Fig. 10 Typ. switching energy versus gate resistor (turn off)

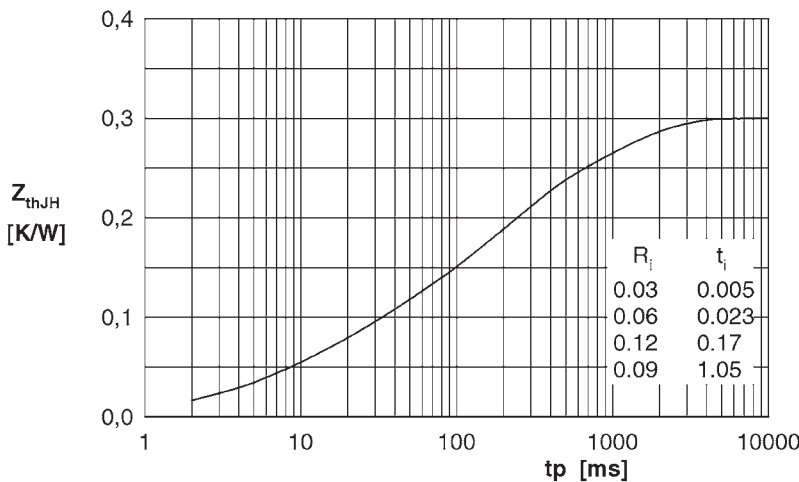


Fig. 11 IGBT: Typ. transient thermal impedance to heat sink

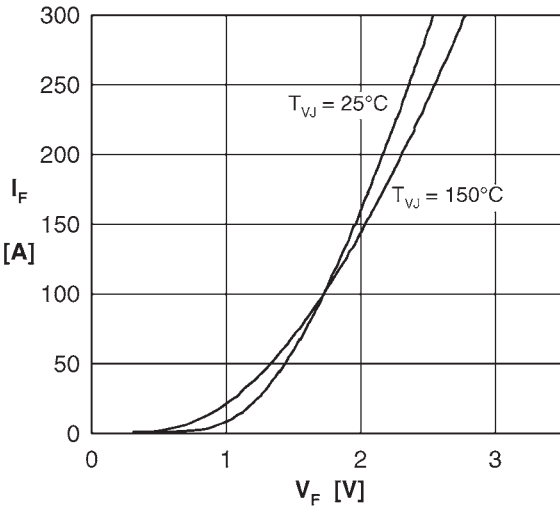
Diodes D1 - D6


Fig. 12 Typ. forward characteristics FWD

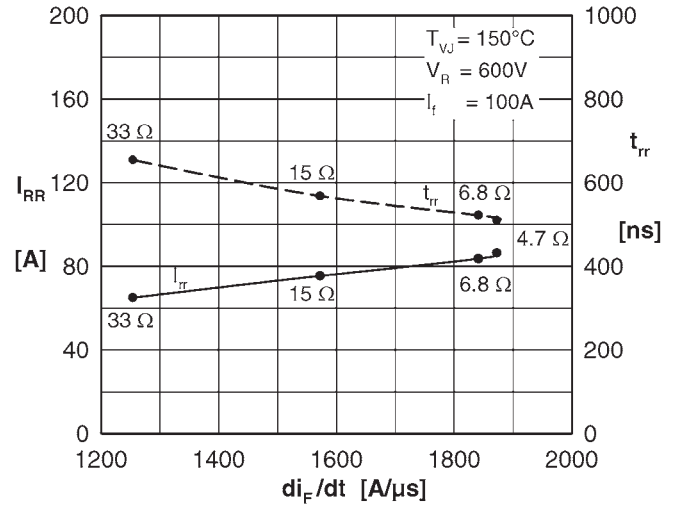
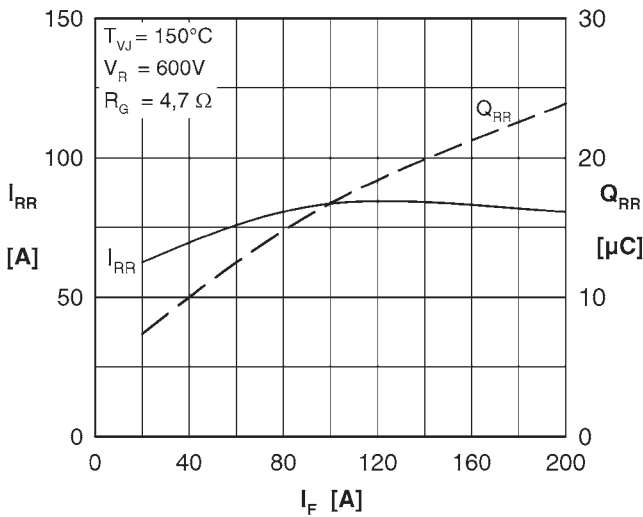

 Fig. 13 Typ. recovery energy $E_{rec(off)}$ versus $-di/dt$ and gate resistor R_G


Fig. 14 typ. reverse recovery characteristics

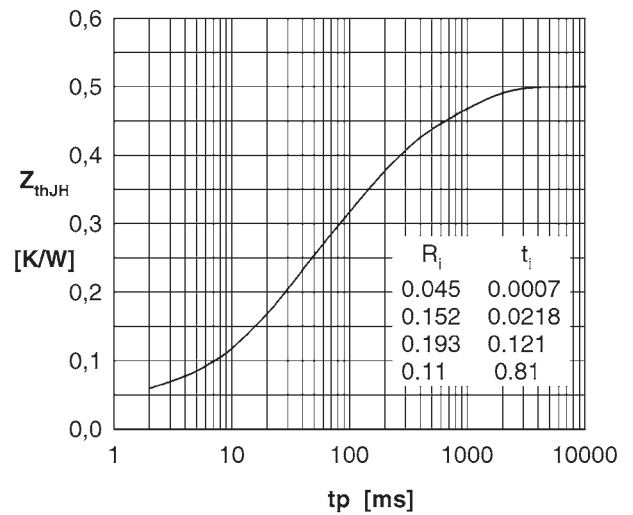


Fig. 15 Diode: Typ. transient thermal impedance junction to heat sink