

SRUK208x Series

RoHS

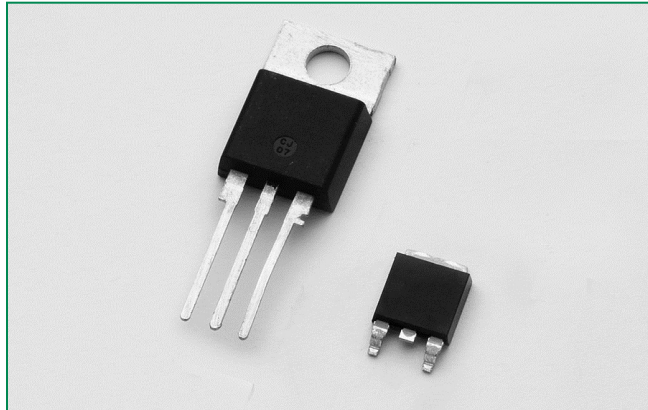

Description

The SRUK208x SCR series is specifically designed for high voltage capacitor discharge application

Features & Benefits

- High forward blocking voltage of 1200V
- High pulse current handling capability
- High di/dt of 350A/μs
- Reverse direction not design to function

Main Features

Symbol	Value	Unit
$I_{T(RMS)}$	8	A
V_{DRM}	1200	V
V_{RRM}	N/A	V
I_{GT}	15	mA

Applications

Typical applications are high voltage pulse generation by capacitor discharge for electric fences, CEWs (contact electric weapon) and high-power strobe lights.

Schematic Symbol

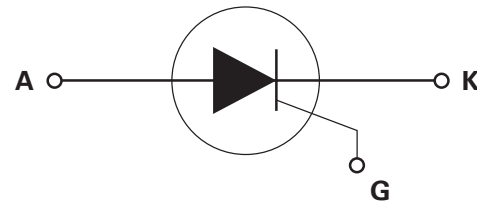

Absolute Maximum Ratings – Standard SCRs

Symbol	Parameter	Test Conditions	Value	Unit
V_{DSM}	Non-repetitive peak off-state voltage	$T_J = 25^\circ\text{C}$	1400	V
$I_{T(RMS)}$	RMS on-state current	SRUK208R $T_C = 105^\circ\text{C}$	8	A
$I_{T(AV)}$	Average on-state current	SRUK208D $T_C = 110^\circ\text{C}$	5.1	A
I_{TSM}	Peak non-repetitive surge current	single half cycle; $f = 50\text{Hz}$; T_J (initial) = 25°C	83	A
		single half cycle; $f = 60\text{Hz}$; T_J (initial) = 25°C	100	
I_{TRM}	Peak Repetitive Pulse Current	Double-exponential, $1.7\mu\text{s} \times 7\mu\text{s}$, $f = 44\text{Hz}$, $T_A = 50^\circ\text{C}$	400	A
I^2t	I^2t Value for fusing	$t_p = 8.3\text{ ms}$	41	A^2s
di/dt	Critical rate-of-rise of on-state current	$T_J = 50^\circ\text{C}$	350	$\text{A}/\mu\text{s}$
I_{GM}	Peak gate current	$T_p = 10\mu\text{s}$, $T_J = 125^\circ\text{C}$	3	A
$P_{G(AV)}$	Average gate power dissipation	$T_J = 125^\circ\text{C}$	0.5	W
T_{stg}	Storage temperature range		-40 to 150	$^\circ\text{C}$
T_J	Operating junction temperature range		-40 to 125	$^\circ\text{C}$

Electrical Characteristics ($T_J = 25^\circ\text{C}$, unless otherwise specified)

Symbol	Test Conditions		Value	Unit
I_{GT}	$V_D = 12\text{V}$ $R_L = 60\ \Omega$	MIN.	5	mA
		MAX.	15	
V_{GT}		MAX.	1.5	V
dv/dt	$V_D = V_{DRM}$; gate open; $T_J = 125^\circ\text{C}$	MIN.	100	V/ μs
V_{GD}	$V_D = V_{DRM}$ $R_L = 3.3\ \text{k}\Omega$ $T_J = 125^\circ\text{C}$	MIN.	0.2	V
I_H	$I_T = 200\text{mA}$ (initial)	MIN.	10	mA
		MAX.	30	
t_q	$I_T = 0.5\text{A}$; $t_p = 50\ \mu\text{s}$; $dv/dt = 5\text{V}/\mu\text{s}$; $di/dt = -30\text{A}/\mu\text{s}$	TYP.	40	μs
t_{gt}	$I_G = 2 \times I_{GT}$ $PW = 15\ \mu\text{s}$ $I_T = 16\text{A}$	TYP.	1	μs

Static Characteristics

Symbol	Test Conditions		Value	Unit
V_{TM}	$I_T = 16\text{A}$; $t_p = 380\ \mu\text{s}$	MAX.	1.6	V
I_{DRM}	V_{DRM}	$T_J = 25^\circ\text{C}$	10	μA
		$T_J = 125^\circ\text{C}$	4	mA

Thermal Resistances

Symbol	Parameter		Value	Unit
$R_{\theta(J-C)}$	Junction to case (AC)	SRUK208R	1.8	$^\circ\text{C}/\text{W}$
		SRUK208D	1.5	

Figure 1: Normalized DC Gate Trigger Current vs. Junction Temperature

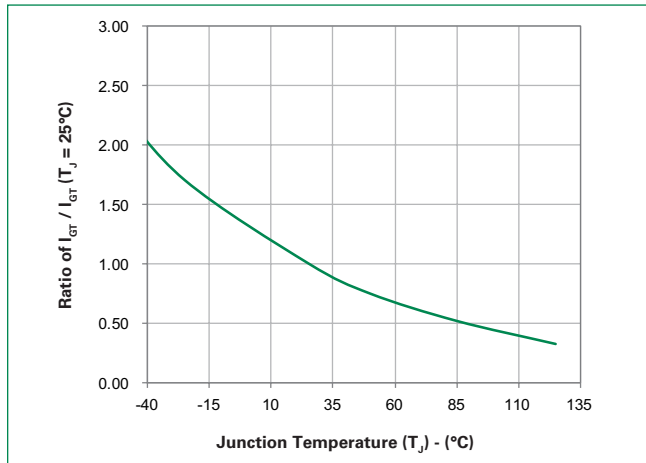

Figure 2: Normalized DC Gate Trigger Voltage vs. Junction Temperature

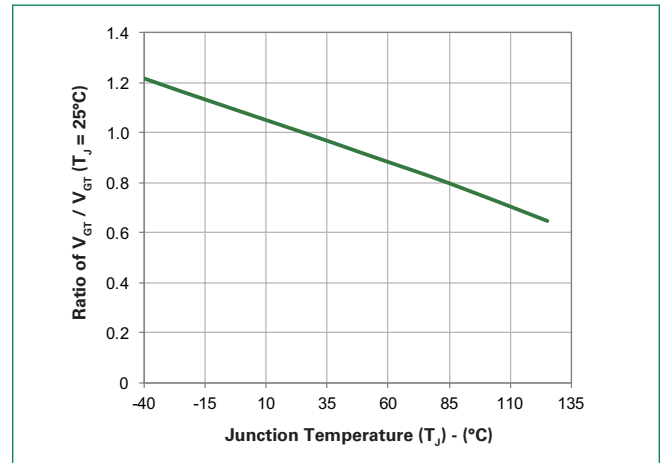

Figure 3: Normalized DC Holding Current vs. Junction Temperature

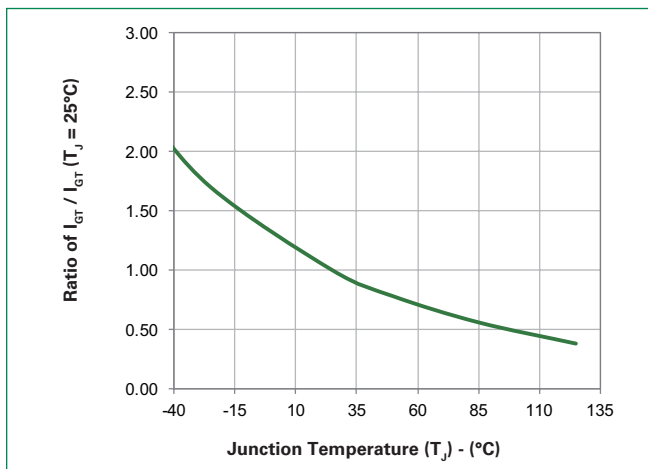

Figure 4: On-State Current vs. On-State Voltage (Typical)

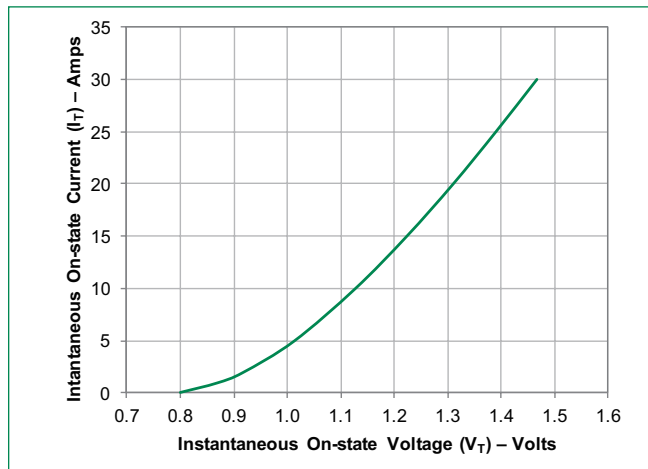

Figure 5: Power Dissipation (Typical) vs. RMS On-State Current

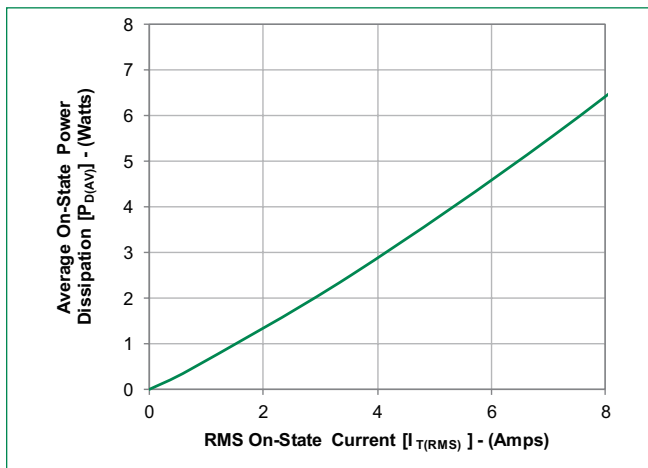

Figure 6: Maximum Allowable Case Temperature vs. RMS On-State Current

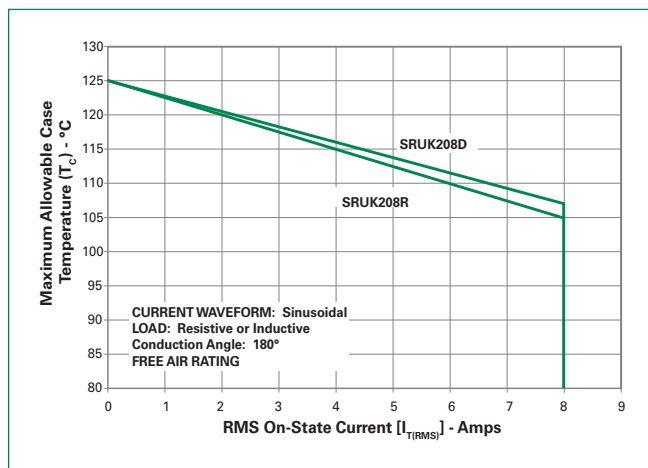

Figure 7: Maximum Allowable Case Temperature vs. Average On-State Current

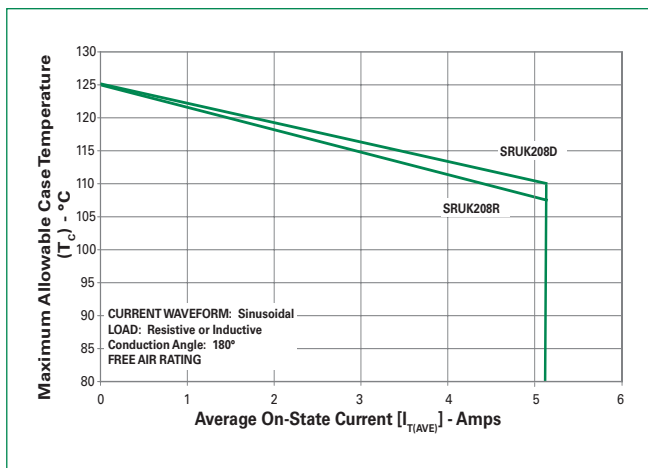

Figure 8: Peak Capacitor Discharge Current

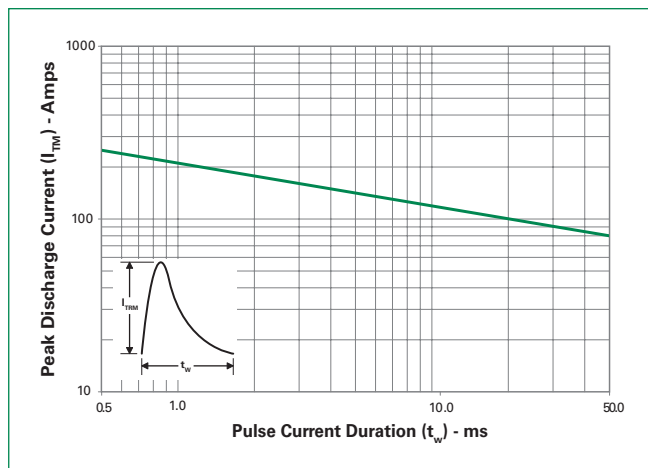

Figure 9: Peak Capacitor Discharge Current Derating

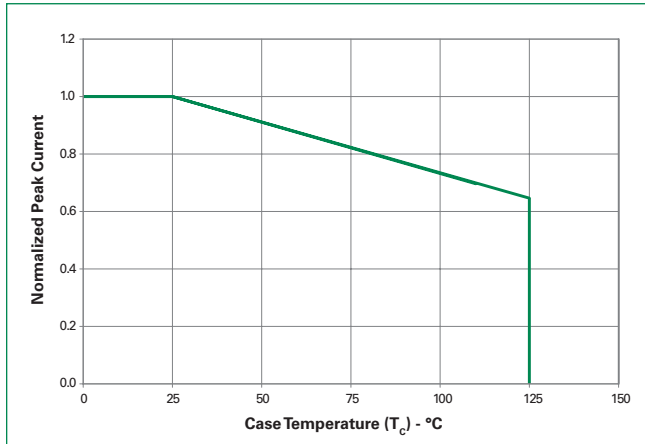
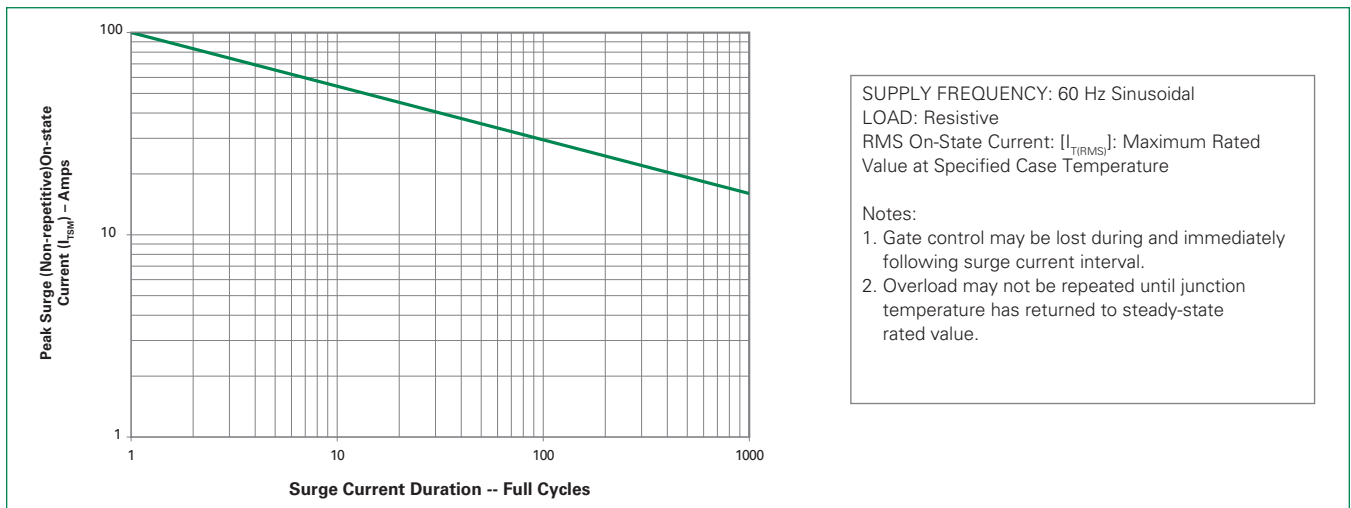
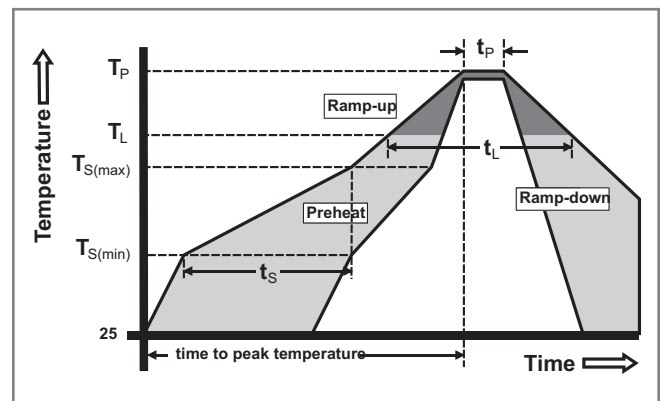

Figure 10: Surge Peak On-State Current vs. Number of Cycles



Soldering Parameters

Reflow Condition	Pb – Free assembly	
Pre Heat	- Temperature Min ($T_{s(min)}$)	150°C
	- Temperature Max ($T_{s(max)}$)	200°C
	- Time (min to max) (t_s)	60 – 180 secs
Average ramp up rate (Liquidus Temp (T_L) to peak)	5°C/second max	
$T_{s(max)}$ to T_L - Ramp-up Rate	5°C/second max	
Reflow	- Temperature (T_L) (Liquidus)	217°C
	- Time (t_L)	60 – 150 seconds
Peak Temperature (T_p)	260 ^{+0/-5} °C	
Time within 5°C of actual peak Temperature (t_p)	20 – 40 seconds	
Ramp-down Rate	5°C/second max	
Time 25°C to peak Temperature (T_p)	8 minutes Max.	
Do not exceed	280°C	



Physical Specifications

Terminal Finish	100% Matte Tin-plated
Body Material	UL Recognized epoxy meeting flammability rating V-0
Lead Material	Copper Alloy

Design Considerations

Careful selection of the correct component for the application's operating parameters and environment will go a long way toward extending the operating life of the Thyristor. Good design practice should limit the maximum continuous current through the main terminals to 75% of the component rating. Other ways to ensure long life for a power discrete semiconductor are proper heat sinking and selection of voltage ratings for worst case conditions. Overheating, overvoltage (including dv/dt), and surge currents are the main killers of semiconductors. Correct mounting, soldering, and forming of the leads also help protect against component damage.

Environmental Specifications

Test	Specifications and Conditions
AC Blocking	Rectified Peak AC voltage@125°C for 96 hours
DC Blocking	96hours; DC 1200V@85°C
Temperature/Humidity	96hours; 320V –DC; 85°C 85% rel humidity
Temperature Cycling	100cycles; -40°C to +125°C; 15-min dwell-time
Resistance to Solder Heat	MIL-STD-750 Method 2031
Solderability	ANSI/J-STD-002, category 3, Test A

Dimensions — TO-220AB (R-Package) — Non-Isolated Mounting Tab Common with Center Lead

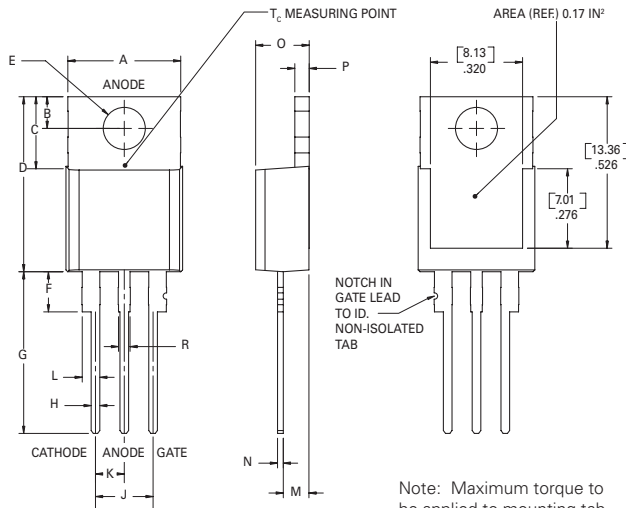

Dimension	Inches		Millimeters	
	Min	Max	Min	Max
A	0.380	0.420	9.65	10.67
B	0.105	0.115	2.67	2.92
C	0.230	0.250	5.84	6.35
D	0.590	0.620	14.99	15.75
E	0.142	0.147	3.61	3.73
F	0.110	0.130	2.79	3.30
G	0.540	0.575	13.72	14.61
H	0.025	0.035	0.64	0.89
J	0.195	0.205	4.95	5.21
K	0.095	0.105	2.41	2.67
L	0.060	0.075	1.52	1.91
M	0.085	0.095	2.16	2.41
N	0.018	0.024	0.46	0.61
O	0.178	0.188	4.52	4.78
P	0.045	0.060	1.14	1.52
R	0.038	0.048	0.97	1.22

Dimensions — TO-252AA (D-Package) — D-PAK Surface Mount

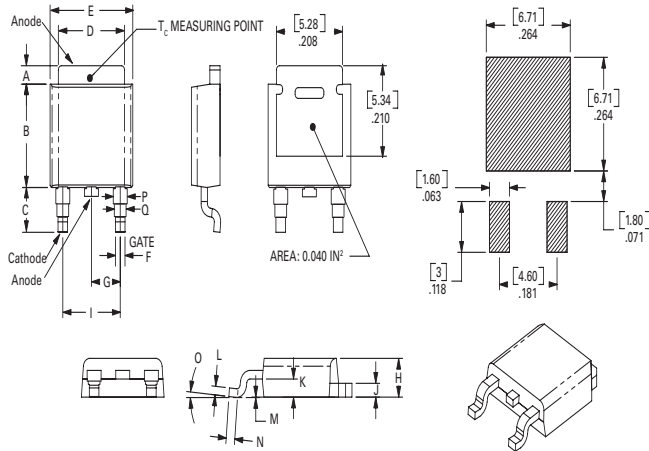

Dimension	Inches			Millimeters		
	Min	Typ	Max	Min	Typ	Max
A	0.037	0.040	0.043	0.94	1.01	1.09
B	0.235	0.243	0.245	5.97	6.16	6.22
C	0.106	0.108	0.113	2.69	2.74	2.87
D	0.205	0.208	0.213	5.21	5.29	5.41
E	0.255	0.262	0.265	6.48	6.65	6.73
F	0.027	0.031	0.033	0.69	0.80	0.84
G	0.087	0.090	0.093	2.21	2.28	2.36
H	0.085	0.092	0.095	2.16	2.33	2.41
I	0.176	0.179	0.184	4.47	4.55	4.67
J	0.018	0.020	0.023	0.46	0.51	0.58
K	0.035	0.037	0.039	0.90	0.95	1.00
L	0.018	0.020	0.023	0.46	0.51	0.58
M	0.000	0.000	0.004	0.00	0.00	0.10
N	0.021	0.026	0.027	0.53	0.67	0.69
O	0°	0°	5°	0°	0°	5°
P	0.042	0.047	0.052	1.06	1.20	1.32
Q	0.034	0.039	0.044	0.86	1.00	1.11

Packing Options

Part Number	Marking	Package	Type	Weight	Packing Mode	Base Quantity
SRUK208RTP	SRUK208R	TO-220R	Standard SCR	2.2 g	Tube	500
SRUK208DRP	SRUK208D	TO-252	Standard SCR	0.3 g	Embossed Carrier	2500

Part Numbering System

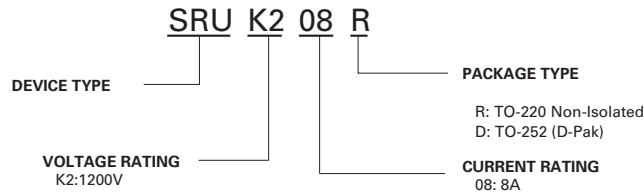

Part Marking System

TO-220 AB - (R Package) TO-252AA - (D Package)

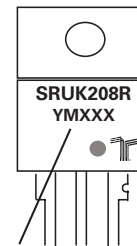

Date Code Marking
Y: Year Code
M: Month Code
XXX: Lot Trace Code

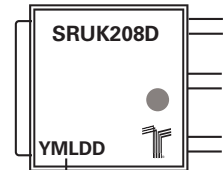

Date Code Marking
Y: Year Code
M: Month Code
L: Location Code
DD: Calendar Code

TO-252 Embossed Carrier Reel Pack (RP) Specifications

Meets all EIA-481-2 Standards

