

PolarHV™ HiPerFET IXFR 80N50P

Power MOSFET

ISOPLUS247™

(Electrically Isolated Back Surface)

N-Channel Enhancement Mode
Avalanche Rated
Fast Intrinsic Diode

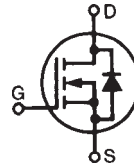

$$V_{DSS} = 500 \text{ V}$$

$$I_{D25} = 45 \text{ A}$$

$$R_{DS(on)} \leq 72 \text{ m}\Omega$$

$$t_{rr} \leq 200 \text{ ns}$$

Symbol	Test Conditions	Maximum Ratings	
V_{DSS}	$T_J = 25^\circ\text{C}$ to 150°C	500	V
V_{DGR}	$T_J = 25^\circ\text{C}$ to 150°C ; $R_{GS} = 1 \text{ M}\Omega$	500	V
V_{GSM}	Transient	± 40	V
V_{GSM}	Continuous	± 30	V
I_{D25}	$T_C = 25^\circ\text{C}$	45	A
I_{DM}	$T_C = 25^\circ\text{C}$, pulse width limited by T_{JM}	200	A
I_{AR}	$T_C = 25^\circ\text{C}$	80	A
E_{AR}	$T_C = 25^\circ\text{C}$	80	mJ
E_{AS}	$T_C = 25^\circ\text{C}$	3.5	J
dv/dt	$I_S \leq I_{DM}$, $di/dt \leq 100 \text{ A}/\mu\text{s}$, $V_{DD} \leq V_{DSS}$, $T_J \leq 150^\circ\text{C}$, $R_G = 2 \Omega$	20	V/ns
P_D	$T_C = 25^\circ\text{C}$	360	W
T_J		-55 ... +150	$^\circ\text{C}$
T_{JM}		150	$^\circ\text{C}$
T_{stg}		-55 ... +150	$^\circ\text{C}$
T_L	Maximum lead temperature for soldering	300	$^\circ\text{C}$
F_C	Mounting force	20..120/4.5..25	N/lb
V_{ISOL}	50/60 Hz, RMS, 1 minute	2500	V~
Weight		5	g

ISOPLUS247 (IXFR)
E153432

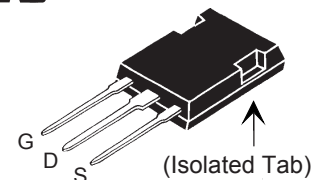

G = Gate D = Drain
S = Source

Features

- 1 Silicon chip on Direct-Copper-Bond substrate
- High power dissipation
- Isolated mounting surface
- 2500V electrical isolation
- 1 Low drain to tab capacitance (<30pF)
- 1 Low $R_{DS(on)}$ HDMOS™ process
- 1 Rugged polysilicon gate cell structure
- 1 Rated for Unclamped Inductive Load Switching (UIS)
- 1 Fast intrinsic Rectifier

Applications

- 1 DC-DC converters
- 1 Battery chargers
- 1 Switched-mode and resonant-mode power supplies
- 1 DC choppers
- 1 AC motor control

Advantages

- 1 Easy assembly
- 1 Space savings
- 1 High power density

Symbol	Test Conditions ($T_J = 25^\circ\text{C}$ unless otherwise specified)	Characteristic Values		
		Min.	Typ.	Max.
BV_{DSS}	$V_{GS} = 0 \text{ V}$, $I_D = 500 \mu\text{A}$	500		V
$V_{GS(th)}$	$V_{DS} = V_{GS}$, $I_D = 8 \text{ mA}$	3.0		5.0 V
I_{GSS}	$V_{GS} = \pm 30 \text{ V}_{DC}$, $V_{DS} = 0$			$\pm 200 \text{ nA}$
I_{DSS}	$V_{DS} = V_{DSS}$, $V_{GS} = 0 \text{ V}$, $T_J = 125^\circ\text{C}$			25 μA 2 mA
$R_{DS(on)}$	$V_{GS} = 10 \text{ V}$, $I_D = 40 \text{ A}$			72 m Ω

Symbol	Test Conditions	Characteristic Values		
		(T _J = 25° C unless otherwise specified)		
		Min.	Typ.	Max.
g_{fs}	V _{DS} = 20 V; I _D = 40 A, I _{D25} , Note 1	45	70	S
C_{iss}			12.7	nF
C_{oss}	V _{GS} = 0 V, V _{DS} = 25 V, f = 1 MHz		1280	pF
C_{rss}			120	pF
t_{d(on)}			25	ns
t_r	V _{GS} = 10 V, V _{DS} = 0.5 V _{DSS} , I _D = 40 A		27	ns
t_{d(off)}	R _G = 1 Ω (External)		70	ns
t_f			16	ns
Q_{g(on)}			197	nC
Q_{gs}	V _{GS} = 10 V, V _{DS} = 0.5 V _{DSS} , I _D = 40 A		70	nC
Q_{gd}			64	nC
R_{thJC}				0.35° C/W
R_{thCS}		0.15		° C/W

Source-Drain Diode

Symbol	Test Conditions	Characteristic Values		
		(T _J = 25° C unless otherwise specified)		
		Min.	Typ.	Max.
I_S	V _{GS} = 0 V			80 A
I_{SM}	Repetitive			200 A
V_{SD}	I _F = I _S , V _{GS} = 0 V,			1.5 V
t_{rr}	I _F = 25 A, -di/dt = 100 A/μs			200 ns
Q_{RM}	V _R = 100 V, V _{GS} = 0 V		0.6	μC
I_{RM}			6	A

Notes:

1. Pulse test, t ≤ 300 μs, duty cycle d ≤ 2 %

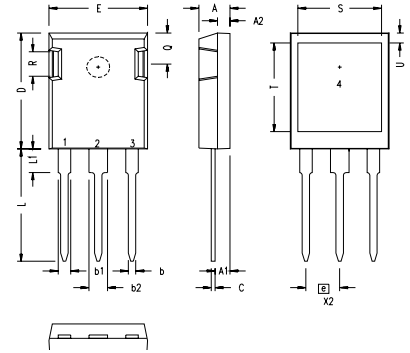
ISOPLUS247™ Outline

SYM	INCHES		MILLIMETERS	
	MIN	MAX	MIN	MAX
A	.190	.205	4.83	5.21
A1	.090	.100	2.29	2.54
A2	.075	.085	1.91	2.16
b	.045	.055	1.14	1.40
b1	.075	.084	1.91	2.13
b2	.115	.123	2.92	3.12
C	.024	.031	0.61	0.80
D	.819	.840	20.80	21.34
E	.620	.635	15.75	16.13
e	.215 BSC		5.45 BSC	
L	.780	.800	19.81	20.32
L1	.150	.170	3.81	4.32
Q	.220	.244	5.59	6.20
R	.170	.190	4.32	4.83
S	.520	.540	13.21	13.72
T	.620	.640	15.75	16.26
U	.065	.080	1.65	2.03

- 1 - GATE
- 2 - DRAIN (COLLECTOR)
- 3 - SOURCE (EMITTER)
- 4 - NO CONNECTION

NOTE: This drawing will meet all dimensions requirement of JEDEC outline TO-247AD except screw hole.

Fig. 1. Output Characteristics @ 25°C

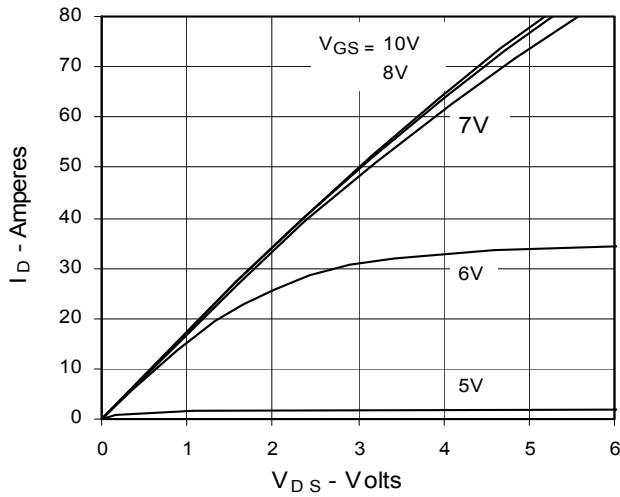

Fig. 2. Extended Output Characteristics @ 25°C

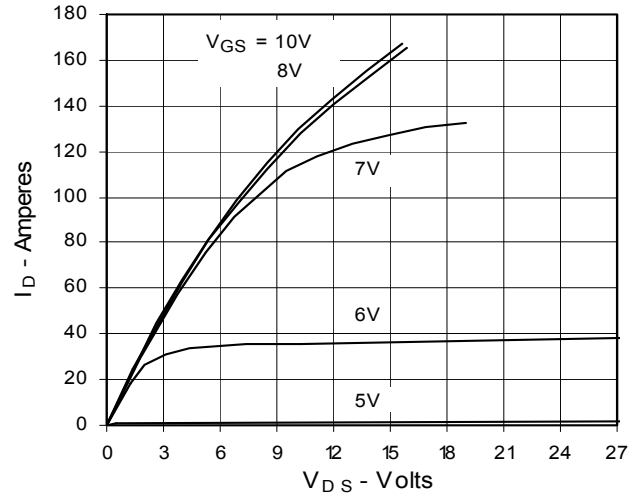

Fig. 3. Output Characteristics @ 125°C

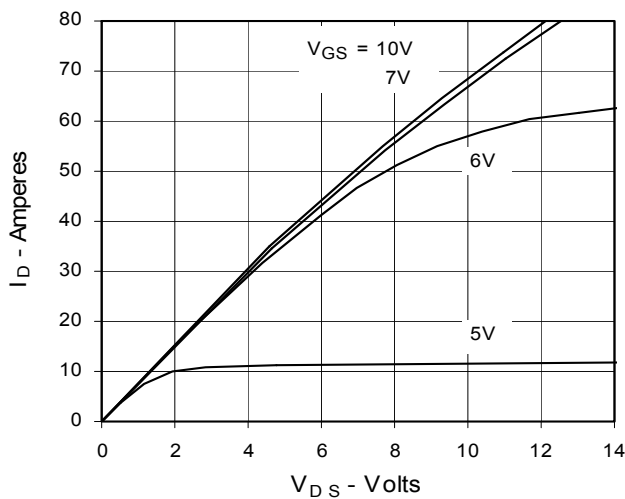

Fig. 4. $R_{DS(on)}$ Normalized to $I_D = 40$ A Value vs. Junction Temperature

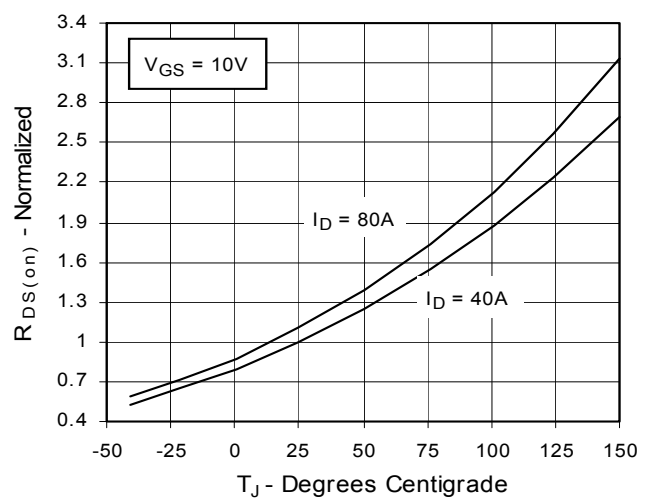

Fig. 5. $R_{DS(on)}$ Normalized to $I_D = 40$ A Value vs. I_D

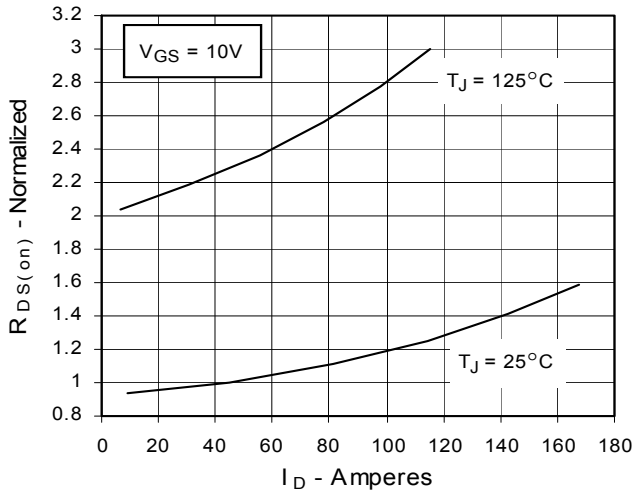

Fig. 6. Drain Current vs. Case Temperature

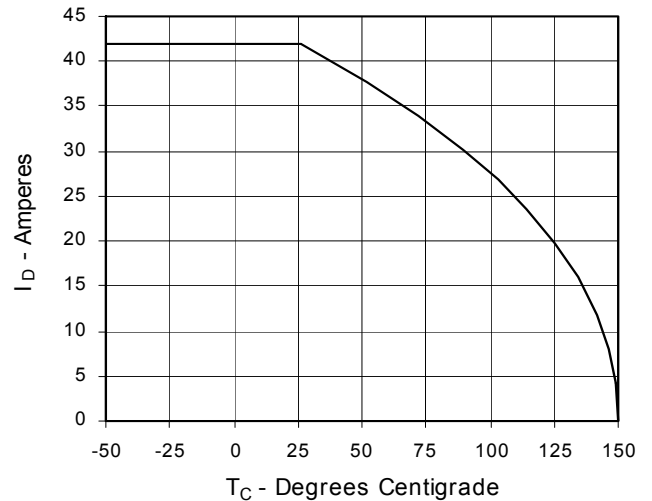

Fig. 7. Input Admittance

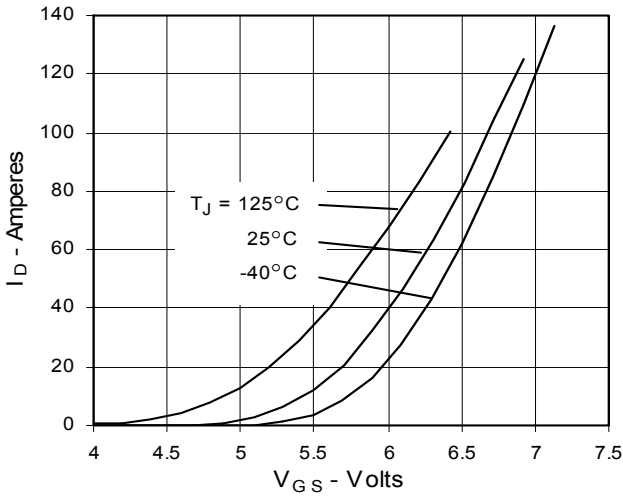

Fig. 8. Transconductance

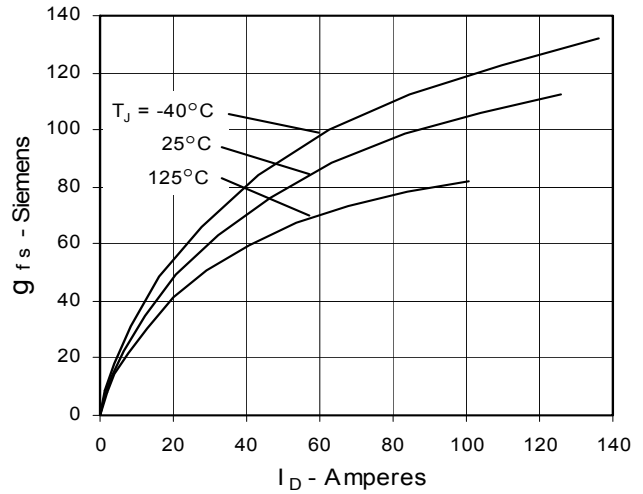

Fig. 9. Source Current vs. Source-To-Drain Voltage

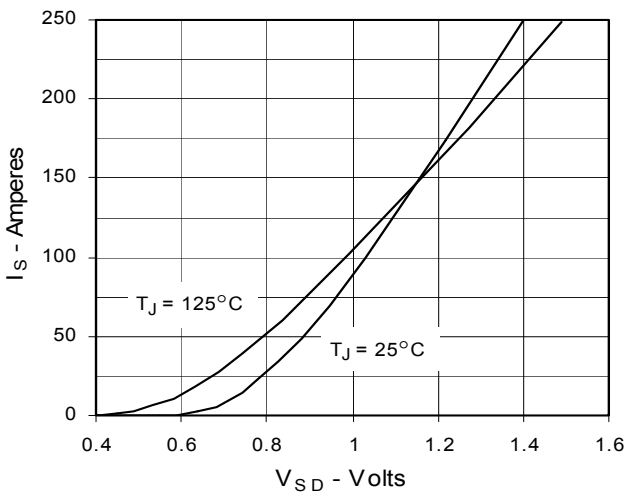

Fig. 10. Gate Charge

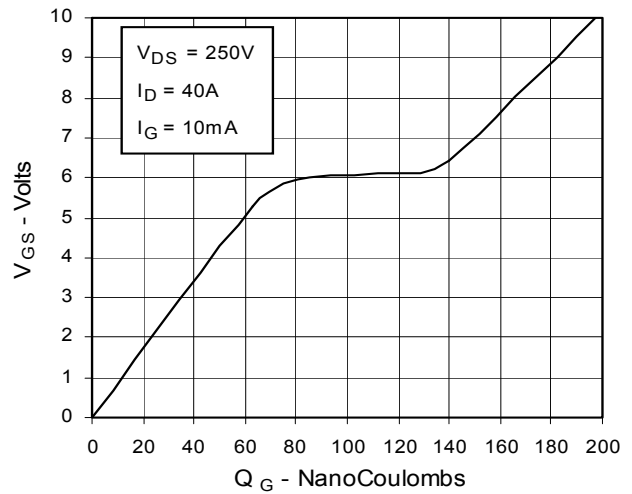

Fig. 11. Capacitance

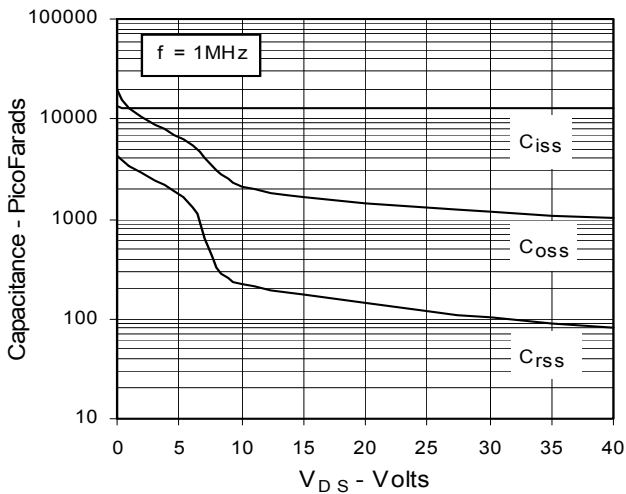

Fig. 12. Forward-Bias Safe Operating Area

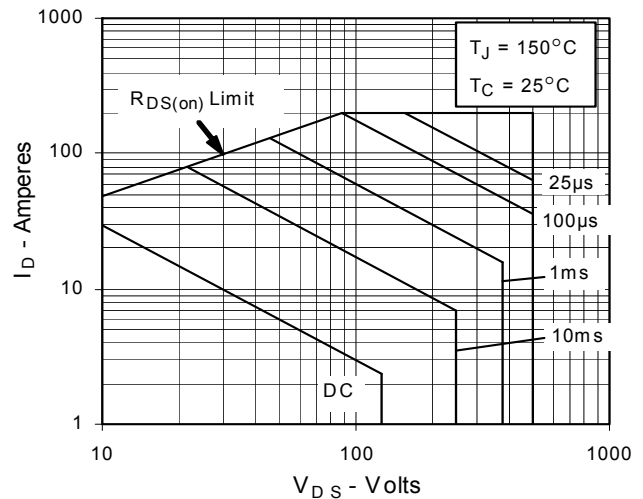
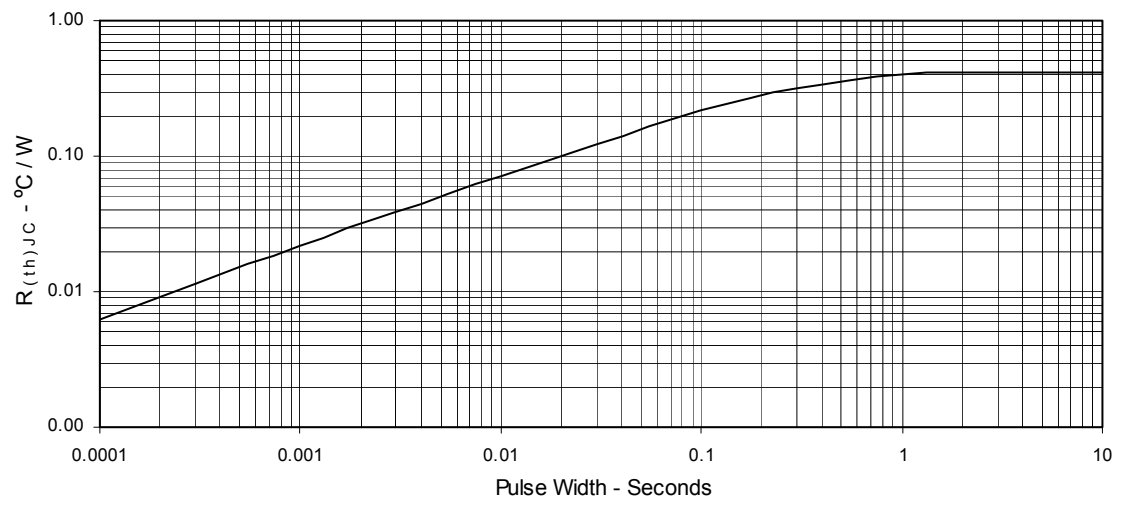

Fig. 13. Maximum Transient Thermal Resistance





Disclaimer Notice - Information furnished is believed to be accurate and reliable. However, users should independently evaluate the suitability of and test each product selected for their own applications. Littelfuse products are not designed for, and may not be used in, all applications. Read complete Disclaimer Notice at www.littelfuse.com/disclaimer-electronics.