

# Polar™ Power MOSFET

## HiPerFET™

# IXFB52N90P

N-Channel Enhancement Mode  
Avalanche Rated  
Fast Intrinsic Diode

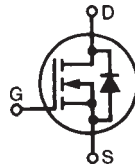

$V_{DSS} = 900V$   
 $I_{D25} = 52A$   
 $R_{DS(on)} \leq 160m\Omega$   
 $t_{rr} \leq 300ns$

Symbol	Test Conditions	Maximum Ratings	
$V_{DSS}$	$T_J = 25^\circ C$ to $150^\circ C$	900	V
$V_{DGR}$	$T_J = 25^\circ C$ to $150^\circ C$ , $R_{GS} = 1M\Omega$	900	V
$V_{GSS}$	Continuous	$\pm 30$	V
$V_{GSM}$	Transient	$\pm 40$	V
$I_{D25}$	$T_C = 25^\circ C$	52	A
$I_{DM}$	$T_C = 25^\circ C$ , Pulse Width Limited by $T_{JM}$	104	A
$I_A$	$T_C = 25^\circ C$	26	A
$E_{AS}$	$T_C = 25^\circ C$	2	J
$dV/dt$	$I_S \leq I_{DM}$ , $V_{DD} \leq V_{DSS}$ , $T_J \leq 150^\circ C$	20	V/ns
$P_D$	$T_C = 25^\circ C$	1250	W
$T_J$		-55 ... +150	$^\circ C$
$T_{JM}$		150	$^\circ C$
$T_{stg}$		-55 ... +150	$^\circ C$
$T_L$	1.6mm (0.062 in.) from Case for 10s	300	$^\circ C$
$T_{SOLD}$	Plastic Body for 10s	260	$^\circ C$
$F_C$	Mounting Force	30..120/6.7..27	N/lb.
<b>Weight</b>		10	g

### PLUS264™

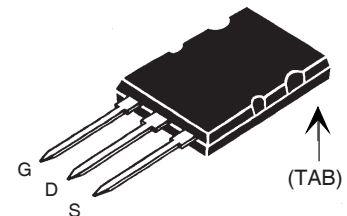

G = Gate      D = Drain  
S = Source      TAB = Drain

### Features

- Fast Intrinsic Diode
- Avalanche Rated
- Low Package Inductance

### Advantages

- Plus 264™ Package for Clip or Spring Mounting
- Space Savings
- High Power Density

### Applications

- Switched-Mode and Resonant-Mode Power Supplies
- DC-DC Converters
- Laser Drivers
- AC and DC Motor drives
- Robotics and Servo Controls

Symbol	Test Conditions ( $T_J = 25^\circ C$ , Unless Otherwise Specified)	Characteristic Values		
		Min.	Typ.	Max.
$BV_{DSS}$	$V_{GS} = 0V$ , $I_D = 3mA$	900		V
$V_{GS(th)}$	$V_{DS} = V_{GS}$ , $I_D = 1mA$	3.5		6.5 V
$I_{GSS}$	$V_{GS} = \pm 30V$ , $V_{DS} = 0V$			$\pm 200$ nA
$I_{DSS}$	$V_{DS} = V_{DSS}$ , $V_{GS} = 0V$ $T_J = 125^\circ C$			50 $\mu A$ 4 mA
$R_{DS(on)}$	$V_{GS} = 10V$ , $I_D = 0.5 \cdot I_{D25}$ , Note 1			160 m $\Omega$

Symbol	Test Conditions	Characteristic Values		
		Min.	Typ.	Max.
$g_{fs}$	$V_{DS} = 20V, I_D = 0.5 \cdot I_{D25}$ , Note 1	20	35	S
$R_{Gi}$	Gate Input Resistance		1.56	$\Omega$
$C_{iss}$	$V_{GS} = 0V, V_{DS} = 25V, f = 1MHz$		19	nF
$C_{oss}$			1180	pF
$C_{rss}$			24	pF
$t_{d(on)}$	<b>Resistive Switching Times</b> $V_{GS} = 10V, V_{DS} = 0.5 \cdot V_{DSS}, I_D = 0.5 \cdot I_{D25}$ $R_G = 1\Omega$ (External)		63	ns
$t_r$			80	ns
$t_{d(off)}$			95	ns
$t_f$			42	ns
$Q_{g(on)}$	$V_{GS} = 10V, V_{DS} = 0.5 \cdot V_{DSS}, I_D = 0.5 \cdot I_{D25}$		308	nC
$Q_{gs}$			117	nC
$Q_{gd}$			132	nC
$R_{thJC}$			0.10	$^{\circ}C/W$
$R_{thCS}$		0.13		$^{\circ}C/W$

Symbol	Test Conditions	Characteristic Values		
		Min.	Typ.	Max.
$I_S$	$V_{GS} = 0V$			52 A
$I_{SM}$	Repetitive, Pulse Width Limited by $T_{JM}$			208 A
$V_{SD}$	$I_F = I_S, V_{GS} = 0V$ , Note 1			1.5 V
$t_{rr}$	$I_F = 26A, -di/dt = 100A/\mu s$ $V_R = 100V$			300 ns
$Q_{RM}$			1.8	$\mu C$
$I_{RM}$			26	A

### PLUS264™ (IXFB) Outline

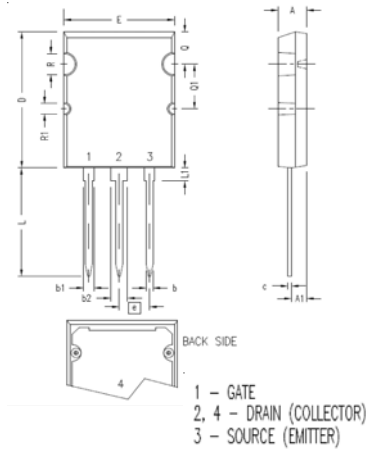

SYM	INCHES		MILLIMETERS	
	MIN	MAX	MIN	MAX
A	.185	.209	4.70	5.31
A1	.102	.118	2.59	3.00
b	.037	.055	0.94	1.40
b1	.087	.102	2.21	2.59
b2	.110	.126	2.79	3.20
c	.017	.029	0.43	0.74
D	1.007	1.047	25.58	26.59
E	.760	.799	19.30	20.29
e	.215 BSC		5.46 BSC	
L	.779	.842	19.79	21.39
L1	.087	.102	2.21	2.59
Q	.240	.256	6.10	6.50
Q1	.330	.346	8.38	8.79
ØR	.155	.187	3.94	4.75
ØR1	.085	.093	2.16	2.36

Note 1: Pulse Test,  $t \leq 300\mu s$ ; Duty Cycle,  $d \leq 2\%$ .

IXYS Reserves the Right to Change Limits, Test Conditions, and Dimensions.

IXYS MOSFETs and IGBTs are covered by one or more of the following U.S. patents:	4,835,592	4,931,844	5,049,961	5,237,481	6,162,665	6,404,065 B1	6,683,344	6,727,585	7,005,734 B2	7,157,338B2
	4,850,072	5,017,508	5,063,307	5,381,025	6,259,123 B1	6,534,343	6,710,405 B2	6,759,692	7,063,975 B2	
	4,881,106	5,034,796	5,187,117	5,486,715	6,306,728 B1	6,583,505	6,710,463	6,771,478 B2	7,071,537	

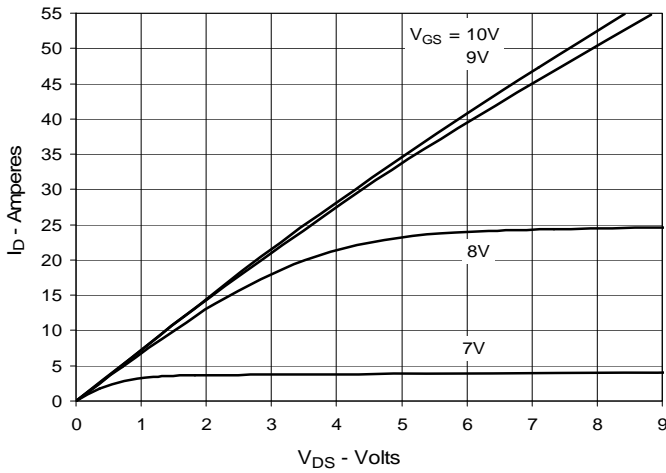
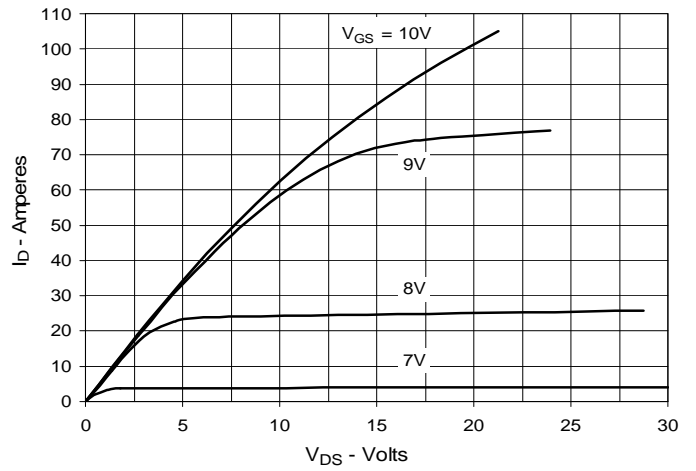
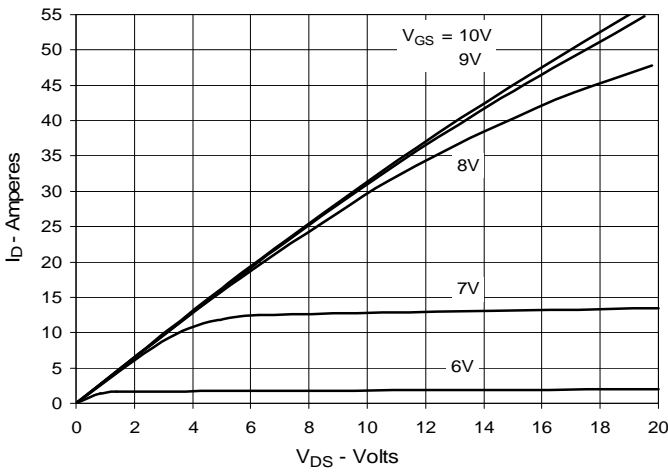
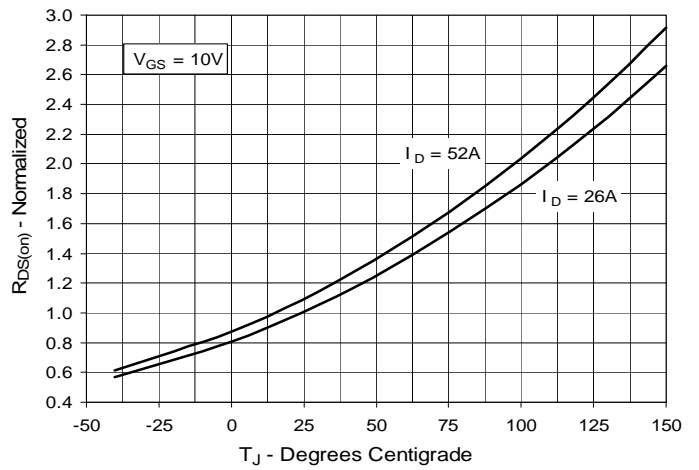
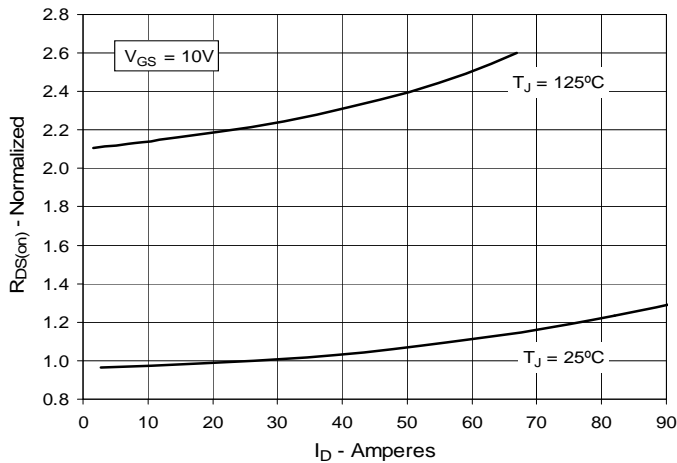
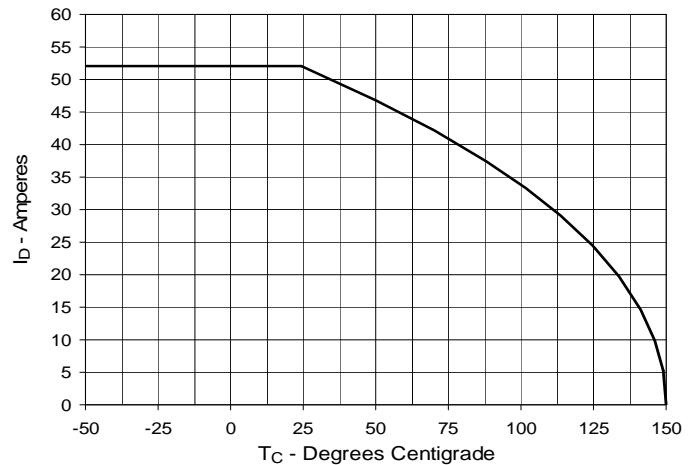
**Fig. 1. Output Characteristics  
@ 25°C**

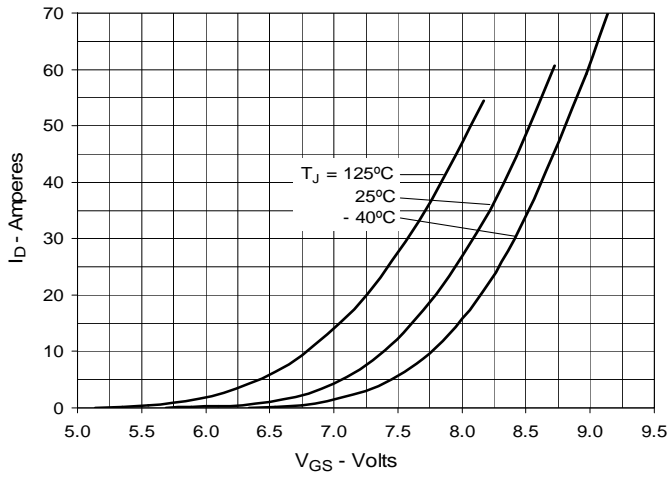
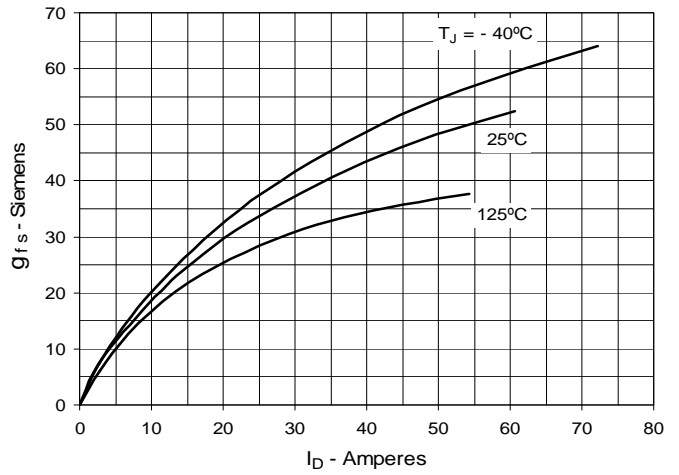
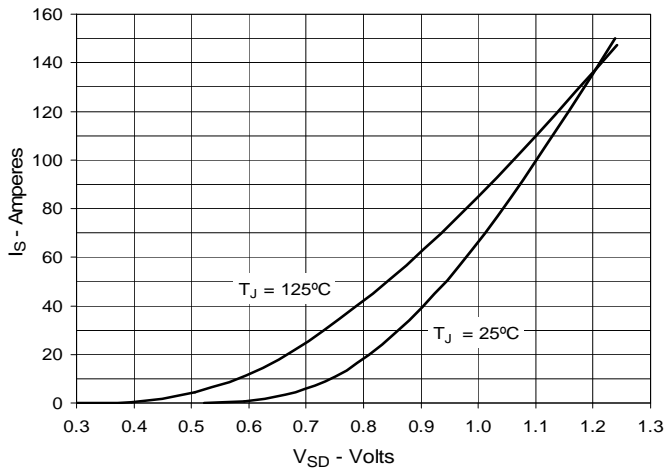
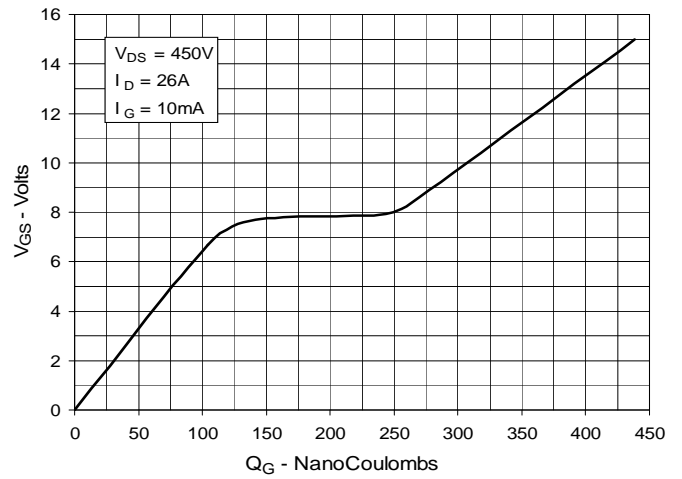
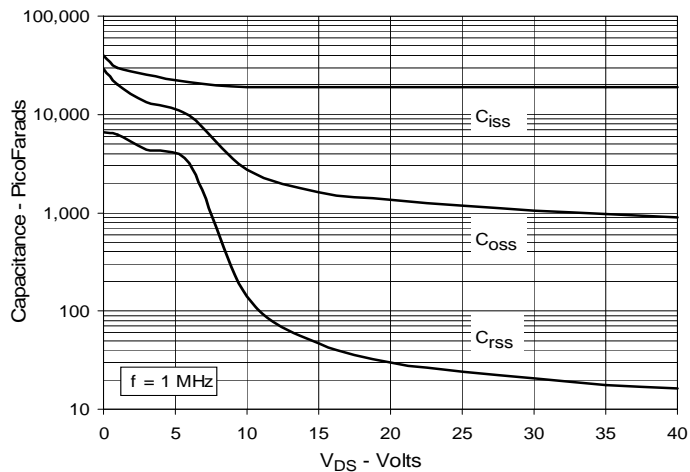
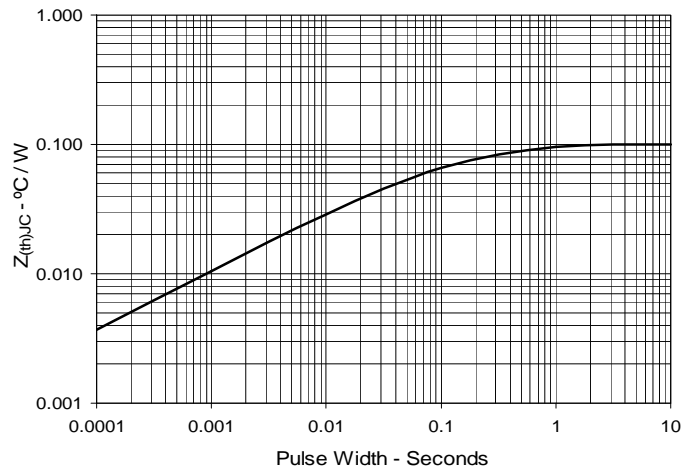
**Fig. 2. Extended Output Characteristics  
@ 25°C**

**Fig. 3. Output Characteristics  
@ 125°C**

**Fig. 4.  $R_{DS(on)}$  Normalized to  $I_D = 26A$  Value  
vs. Junction Temperature**

**Fig. 5.  $R_{DS(on)}$  Normalized to  $I_D = 26A$  Value  
vs. Drain Current**

**Fig. 6. Maximum Drain Current vs.  
Case Temperature**

**Fig. 7. Input Admittance**

**Fig. 8. Transconductance**

**Fig. 9. Forward Voltage Drop of Intrinsic Diode**

**Fig. 10. Gate Charge**

**Fig. 11. Capacitance**

**Fig. 12. Maximum Transient Thermal Impedance**



---

Disclaimer Notice - Information furnished is believed to be accurate and reliable. However, users should independently evaluate the suitability of and test each product selected for their own applications. Littelfuse products are not designed for, and may not be used in, all applications. Read complete Disclaimer Notice at [www.littelfuse.com/disclaimer-electronics](http://www.littelfuse.com/disclaimer-electronics).