

# SP3025 Series

## Lightning Surge Protection

HF RoHS Pb

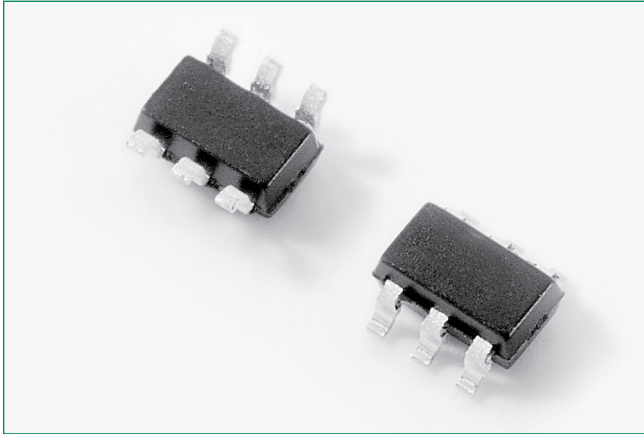

Pinout

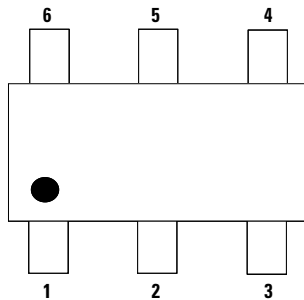

Functional Block Diagram

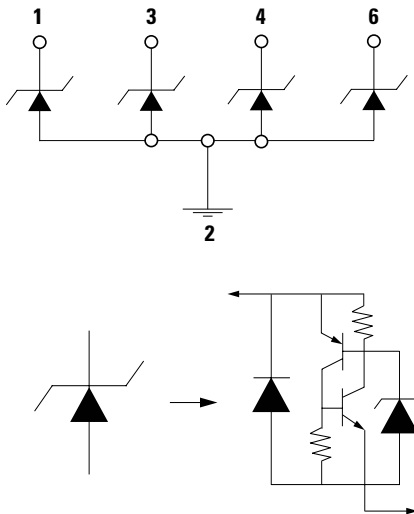

### Description

The SP3025 is a low-capacitance, TVS Diode Array designed to provide protection against ESD (electrostatic discharge), CDE (cable discharge events), EFT (electrical fast transients), and lightning induced surges for highspeed, differential data lines. It's packaged in a SOT23-6L and each device can protect up to 4 channels up to 30A (IEC 61000-4- 5 2nd edition,) and up to  $\pm 30$ kV ESD (IEC 61000-4-2).

The SP3025 with its low capacitance and low clamping voltage makes it ideal for high-speed data interfaces such as 1GbE applications found in notebooks, switches, etc.

### Features & Benefits

- ESD, IEC 61000-4-2,  $\pm 30$ kV contact,  $\pm 30$ kV air
- EFT, IEC 61000-4-4, 40A (5/50ns)
- Lightning, IEC 61000- 4-5 2nd edition, 30A ( $t_P=8/20\mu s$ )
- Low capacitance of 1.7pF@0V (TYP)
- Low leakage current of 1nA (TYP) at 2.5V
- Low operating and clamping voltage
- Provides protection for two differential data pairs (4 channels) up to 30A
- Halogen free, Lead free and RoHS compliant
- Moisture Sensitivity Level (MSL -1)

### Applications

- 10/100/1000 Ethernet
- WAN/LAN Equipment
- Desktops, Servers and Notebooks
- LVDS Interfaces
- Integrated Magnetics
- Smart TV
- 2.5G/5G/10G Ethernet

#### Life Support Note:

#### Not Intended for Use in Life Support or Life Saving Applications

The products shown herein are not designed for use in life sustaining or life saving applications unless otherwise expressly indicated.

# SP3025 Series

## Lightning Surge Protection

### Absolute Maximum Ratings

Symbol	Parameter	Value	Units
$I_{PP}$	Peak Current ( $t_p=8/20\mu s$ )	30	A
$T_{OP}$	Operating Temperature	-40 to 125	°C
$T_{STOR}$	Storage Temperature	-55 to 150	°C

**Caution:** Stresses above those listed in "Absolute Maximum Ratings" may cause permanent damage to the component. This is a stress only rating and operation of the component at these or any other conditions above those indicated in the operational sections of this specification is not implied.

### Electrical Characteristics ( $T_{OP}=25^\circ C$ )

Parameter	Symbol	Test Conditions	Min	Typ	Max	Units
Reverse Standoff Voltage	$V_{RWM}$	$I_R = 1\mu A$			2.5	V
Breakdown Voltage	$V_{BR}$	$I_R = 1mA$	5.5	7.0		V
Reverse Leakage Current	$I_{LEAK}$	$V_R=2.5V$		1	100	nA
Holding Voltage	$V_{HOLD}$	I/O to GND		1.6		V
Clamp Voltage <sup>1</sup>	$V_C$	$I_{PP}=30A, t_p=8/20\mu s$		9	11	V
Dynamic Resistance <sup>2</sup>	$R_{DYN}$	TLP, $t_p=100ns$		0.14		$\Omega$
ESD Withstand Voltage <sup>1,3</sup>	$V_{ESD}$	IEC 61000-4-2 (Contact Discharge)	$\pm 30$			kV
		IEC 61000-4-2 (Air Discharge)	$\pm 30$			kV
Diode Capacitance <sup>1</sup>	$C_{I/O-GND}$	Reverse Bias=0V, f=1MHz		1.7	2.5	pF
	$C_{I/O-I/O}$			0.8	1.2	

#### Notes:

- Parameter is guaranteed by design and/or component characterization.
- Transmission Line Pulse (TLP) test setting : Std.TDR(50 $\Omega$ ), $t_p=100ns$ ,  $tr=0.2ns$  ITLP and VTLP averaging window: start  $t_1=70ns$  to end  $t_2=90ns$
- Device stressed with ten non-repetitive ESD pulses.

### 8/20 $\mu s$ Pulse Waveform

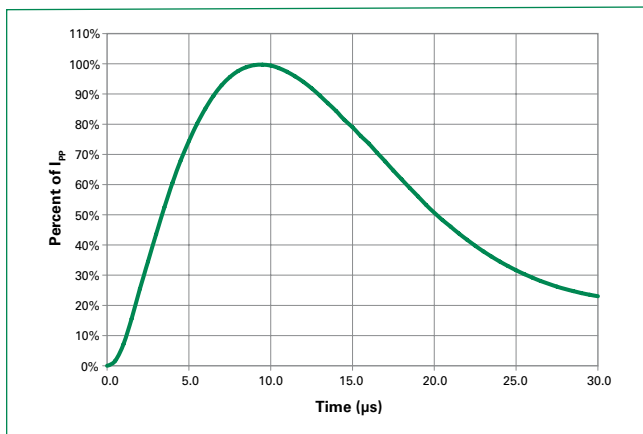

### Capacitance vs. Reverse Bias

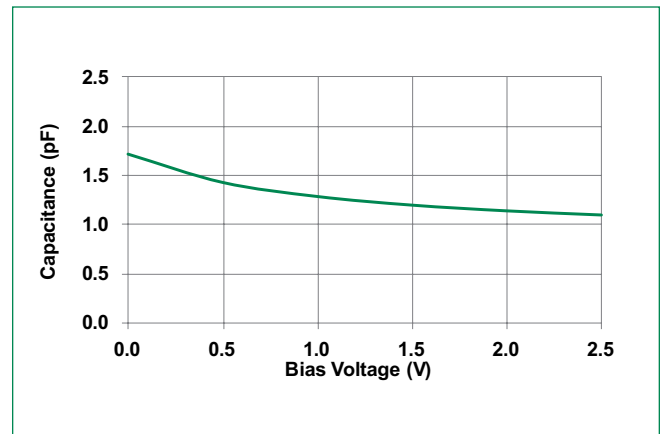

# SP3025 Series

## Lightning Surge Protection

Positive Transmission Line Pulsing (TLP) Plot

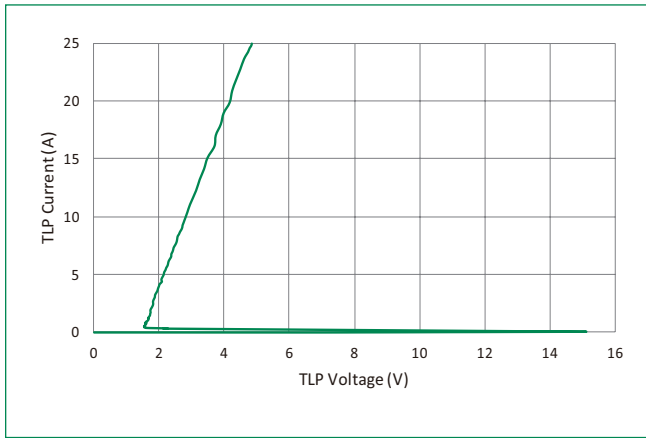

Negative Transmission Line Pulsing (TLP) Plot

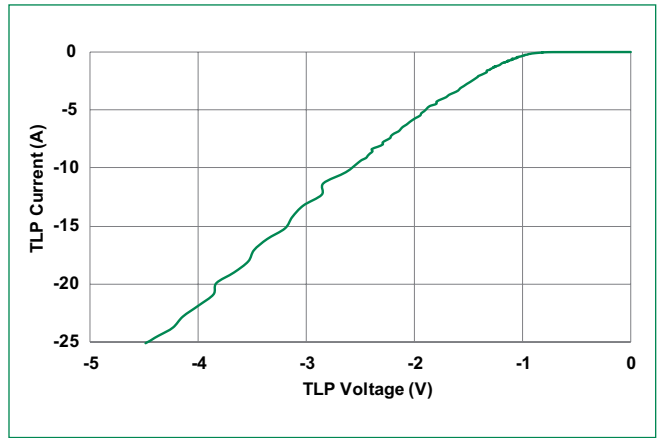

Clamping Voltage vs. Peak Pulse Current

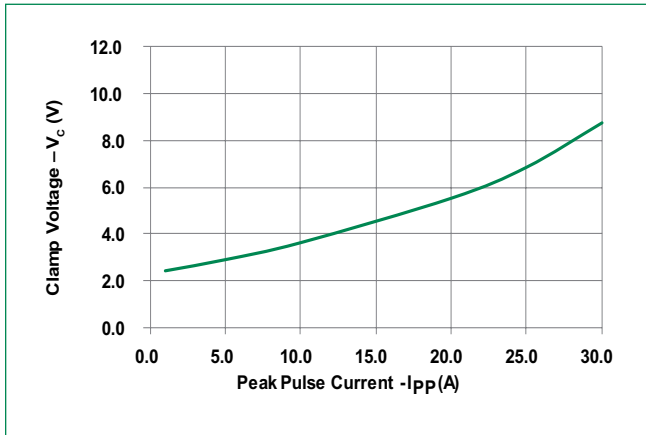

IEC 61000-4-2 +8kV Contact ESD Clamping Voltage

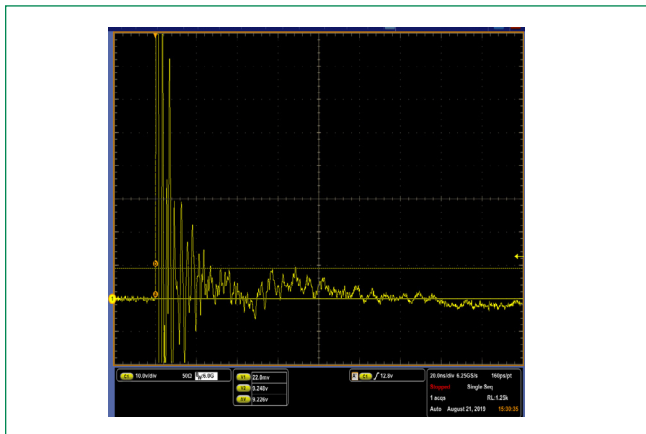

IEC 61000-4-2 -8kV Contact ESD Clamping Voltage

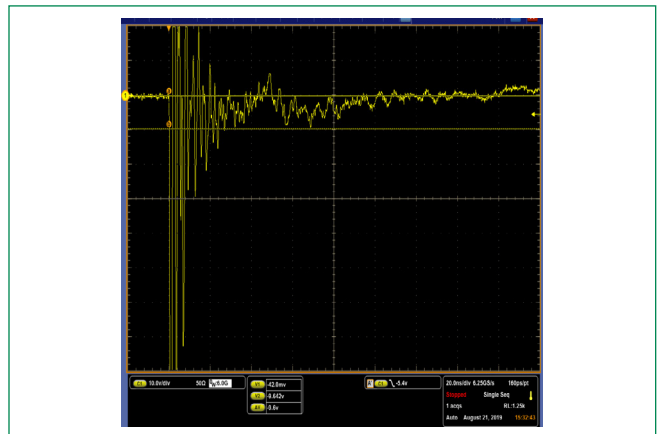

# SP3025 Series

## Lightning Surge Protection

### Soldering Parameters

<b>Reflow Condition</b>		Pb – Free assembly
<b>Pre Heat</b>	- Temperature Min ( $T_{s(min)}$ )	150°C
	- Temperature Max ( $T_{s(max)}$ )	200°C
	- Time (min to max) ( $t_s$ )	60 – 120 secs
<b>Average ramp up rate (Liquidus) Temp (<math>T_L</math>) to peak</b>		3°C/second max
<b><math>T_{s(max)}</math> to <math>T_L</math> - Ramp-up Rate</b>		3°C/second max
<b>Reflow</b>	- Temperature ( $T_L$ ) (Liquidus)	217°C
	- Temperature ( $t_l$ )	60 – 150 seconds
<b>Peak Temperature (<math>T_p</math>)</b>		260 <sup>+0/-5</sup> °C
<b>Time within 5°C of actual peak Temperature (<math>t_p</math>)</b>		30 seconds
<b>Ramp-down Rate</b>		6°C/second max
<b>Time 25°C to peak Temperature (<math>T_p</math>)</b>		8 minutes Max.
<b>Do not exceed</b>		260°C

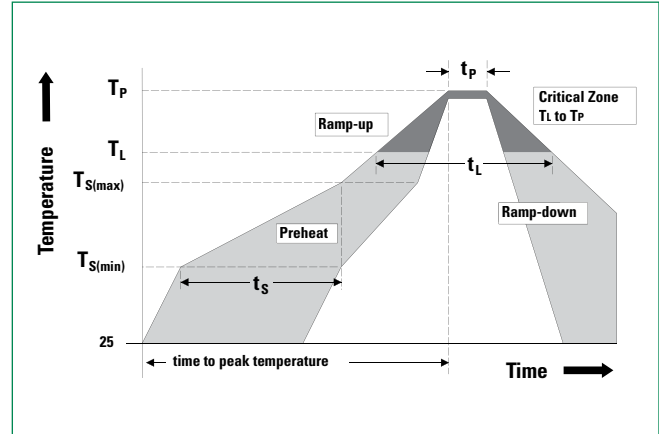

### Ordering Information

Part Number	Package	Min. Order Qty.
SP3025-04HTG	SOT23-6L	3000

### Product Characteristics

<b>Lead Plating</b>	Matte Tin
<b>Lead Material</b>	Copper Alloy
<b>Lead Coplanarity</b>	0.004 inches (0.102mm)
<b>Substrate Material</b>	Silicon
<b>Body Material</b>	Molded Compound
<b>Flammability</b>	UL Recognized compound meeting flammability rating V-0

### Part Marking System

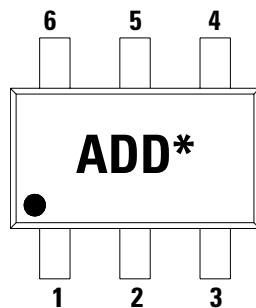

AD : Part code  
 D : Assembly code  
 \* : Date code

### Part Numbering System

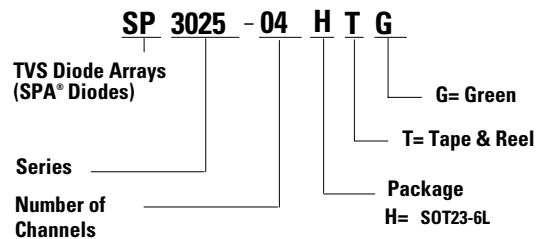

# SP3025 Series

## Lightning Surge Protection

### Package Dimensions – SOT23-6L

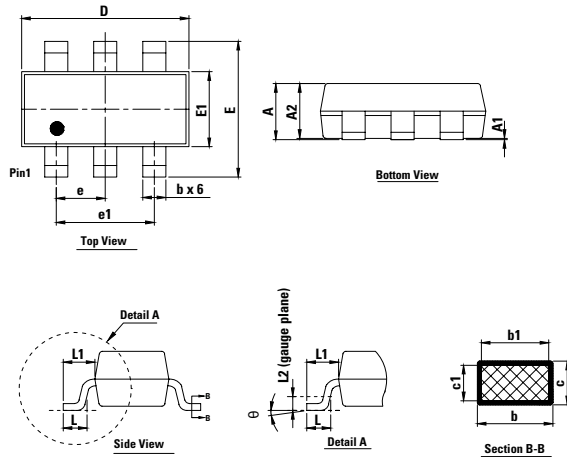

Symbol	Millimeters		
	Min	Nom	Max
A	-	-	1.45
A1	0.00	-	0.15
A2	0.90	1.15	1.30
b	0.30	-	0.50
b1	0.30	0.40	0.45
c	0.08	-	0.22
c1	0.08	0.13	0.20
D	2.75	2.90	3.05
E	2.60	2.80	3.00
E1	1.45	1.60	1.75
e	0.95 BSC		
e1	1.90 BSC		
L	0.30	0.50	0.60
L1	0.60 REF		
L2	0.25 BSC		
θ	0°	4°	8°

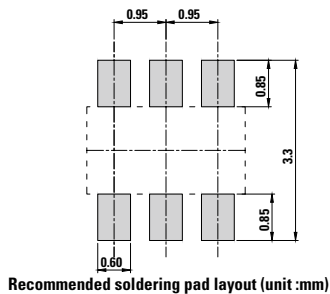

### Embossed Carrier Tape & Reel Specification – SOT23-6L

#### 8mm TAPE AND REEL

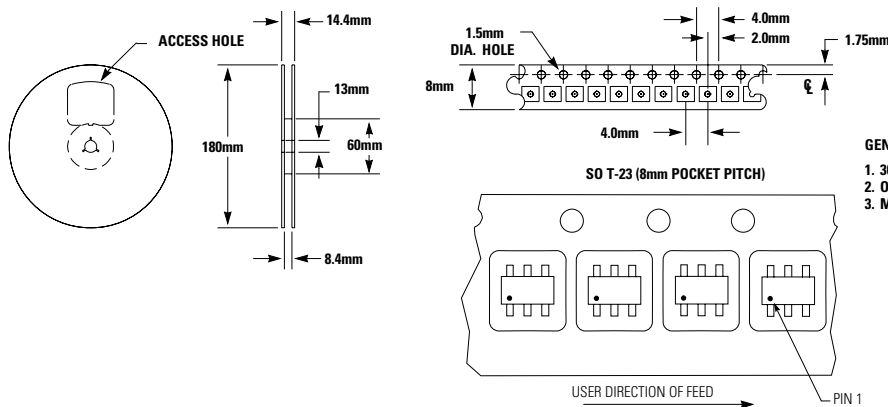

**Disclaimer Notice** - Information furnished is believed to be accurate and reliable. However, users should independently evaluate the suitability of and test each product selected for their own applications. Littelfuse products are not designed for, and may not be used in, all applications. Read complete Disclaimer Notice at <http://www.littelfuse.com/disclaimer-electronics>.