

1.5SMB Series

Surface Mount – 1500W



Maximum Ratings and Thermal Characteristics ($T_A=25^\circ\text{C}$ unless otherwise noted)

Parameter	Symbol	Value	Unit
Peak Pulse Power Dissipation by 10/1000 μs Waveform (Fig.2) (Note 1), (Note 2)	P_{PPM}	1500	W
Power Dissipation on Infinite Heat Sink at $T_c=50^\circ\text{C}$	P_D	5.0	W
Peak Forward Surge Current, 8.3ms Single Half Sine Wave (Note 3)	I_{FSM}	120	A
Maximum Instantaneous Forward Voltage at 50A for Unidirectional Only	V_F	5.0	V
Operating Temperature Range	T_J	-65 to 150	$^\circ\text{C}$
Storage Temperature Range	T_{STG}	-65 to 175	$^\circ\text{C}$
Typical Thermal Resistance Junction to Lead	$R_{\theta JL}$	20	$^\circ\text{C/W}$
Typical Thermal Resistance Junction to Ambient	$R_{\theta JA}$	100	$^\circ\text{C/W}$

Notes:

1. Non-repetitive current pulse, per Fig. 4 and derated above T_J (initial) = 25°C per Fig. 3.
2. Mounted on copper pad area of 0.2x0.2" (5.0 x 5.0mm) to each terminal.
3. Measured on 8.3ms single half sine wave or equivalent square wave for unidirectional component only, duty cycle=4 per minute maximum.

Description

The 1.5SMB Series is designed specifically to protect sensitive electronic equipment from voltage transients induced by lightning and other transient voltage events.

Features & Benefits

- For surface mounted applications to optimize board space
- Low profile package
- Typical failure mode is short from over-specified voltage or current
- Whisker test is conducted based on JEDEC JESD201A per its table 4a and 4c
- ESD protection of data lines in accordance with IEC 61000-4-2, 30kV(Air), 30kV (Contact)
- EFT protection of data lines in accordance with IEC 61000-4-4
- Built-in strain relief
- Glass passivated chip junction
- 1500W peak pulse power capability at 10/1000 μs waveform, repetition rate (duty cycles):0.01%
- $V_{BR} @ T_J = V_{BR} @ 25^\circ\text{C} \times (1 + \alpha_T \times (T_J - 25))$ (α_T : Temperature Coefficient, typical value is 0.1%)
- Excellent clamping capability
- Low incremental surge resistance
- Meet MSL level 1 per J-STD-020, and high temperature soldering guaranteed: 260C/10sec
- Matte tin lead-free Plated
- Halogen free and RoHS compliant
- Pb-free E3 means 2nd level interconnect is Pb-free and the terminal finish material is tin(Sn) (IPC/JEDEC J-STD-609A.01)

Applications

TVS components are ideal for the protection of I/O Interfaces, V_{CC} bus and other vulnerable circuits used in Telecom, Computer, Industrial and Consumer electronic applications.

Functional Diagram

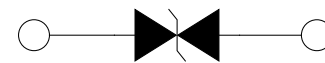

Bi-directional



Uni-directional

1.5SMB Series

Surface Mount – 1500W

Electrical Characteristics ($T_A=25^\circ\text{C}$ unless otherwise noted)

Part Number (Uni)	Part Number (Bi)	Marking		Reverse Stand off Voltage V_R (Volts)	Breakdown Voltage V_{BR} (Volts) @ I_T		Test Current I_T (mA)	Maximum Clamping Voltage V_C @ I_{PP} (10/1000 μs) (V)	Maximum Peak Pulse Current I_{PP} (10/1000 μs) (A)	Maximum Clamping Voltage V_C @ I_{PP} (8/20 μs) (V)	Maximum Peak Pulse Current I_{PP} (8/20 μs) (A)	Maximum Reverse Leakage I_R @ V_R (μA)	Maximum Temperature coefficient of V_{BR} (%/C)
		UNI	BI		MIN	MAX							
1.5SMB20A	1.5SMB20CA	H15I	B15I	17.1	19.0	21.0	1	27.7	54.9	34.8	302.0	20	0.085
1.5SMB22A	1.5SMB22CA	H15K	B15K	18.8	20.9	23.1	1	30.6	49.7	35.0	273.4	10	0.088
1.5SMB23A	1.5SMB23CA	H10L	B10L	20.0	22.0	24.2	1	33.2	45.0	35.0	250.0	1	0.088
1.5SMB24A	1.5SMB24CA	H15N	B15N	20.5	22.8	25.2	1	33.2	45.0	42.9	249.0	1	0.091
1.5SMB27A	1.5SMB27CA	H15P	B15P	23.1	25.7	28.4	1	37.5	40.5	48.4	222.8	1	0.092
1.5SMB30A	1.5SMB30CA	H15S	B15S	25.6	28.5	31.5	1	41.4	36.7	53.5	201.9	1	0.093
1.5SMB33A	1.5SMB33CA	H15V	B15V	28.2	31.4	34.7	1	45.7	33.3	59.0	183.2	1	0.094
1.5SMB36A	1.5SMB36CA	H15Z	B15Z	30.8	34.2	37.8	1	49.9	30.5	64.5	167.8	1	0.096
1.5SMB39A	1.5SMB39CA	N15B	C15B	33.3	37.1	41.0	1	53.9	28.2	69.6	155.1	1	0.097
1.5SMB43A	1.5SMB43CA	N15D	C15D	36.8	40.9	45.2	1	59.3	25.6	76.6	140.8	1	0.098
1.5SMB47A	1.5SMB47CA	N15F	C15F	40.2	44.7	49.4	1	64.8	23.5	83.7	129.3	1	0.099
1.5SMB51A	1.5SMB51CA	N15G	C15G	43.6	48.5	53.6	1	70.1	21.7	90.6	119.4	1	0.100
1.5SMB56A	1.5SMB56CA	N15I	C15I	47.8	53.2	58.8	1	77.0	19.7	99.5	108.4	1	0.101
1.5SMB62A	1.5SMB62CA	N15K	C15K	53.0	58.9	65.1	1	85.0	17.9	109.8	98.5	1	0.102
1.5SMB68A	1.5SMB68CA	N15L	C15L	58.1	64.6	71.4	1	92.0	16.5	118.9	90.8	1	0.103
1.5SMB75A	1.5SMB75CA	N15N	C15N	64.1	71.3	78.8	1	103.0	14.8	133.1	81.4	1	0.104
1.5SMB82A	1.5SMB82CA	N15P	C15P	70.1	77.9	86.1	1	113.0	13.5	146.0	74.3	1	0.105
1.5SMB91A	1.5SMB91CA	N15S	C15S	77.8	86.5	95.5	1	125.0	12.2	161.5	67.1	1	0.106
1.5SMB100A	1.5SMB100CA	N15V	C15V	85.5	95.0	105.0	1	137.0	11.1	177.0	61.1	1	0.106

I-V Curve Characteristics

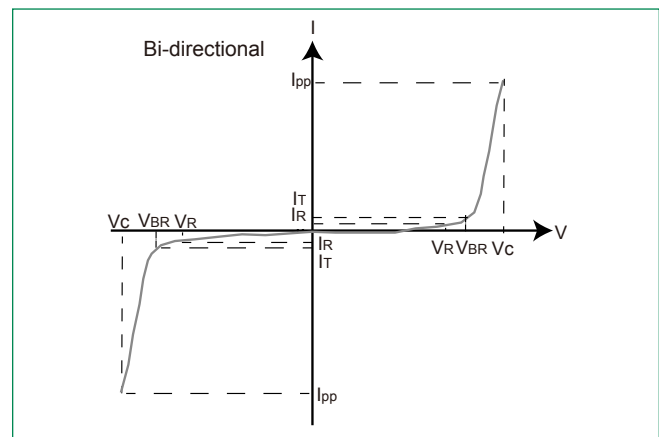
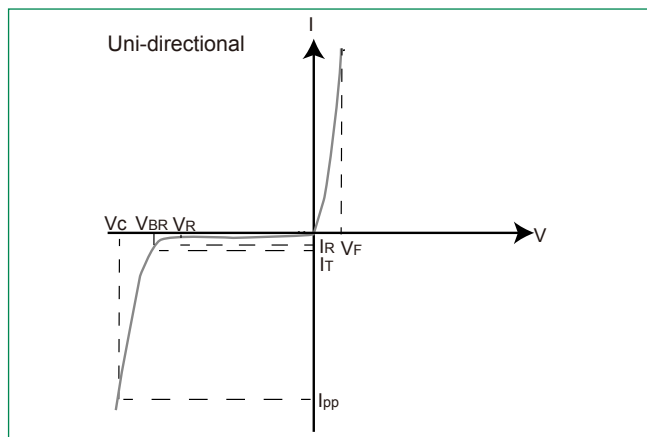

P_{PPM} Peak Pulse Power Dissipation - Max power dissipation

V_R Stand-off Voltage - Maximum voltage that can be applied to the TVS without operation

V_{BR} Breakdown Voltage - Maximum voltage that flows through the TVS at a specified test current (I_T)

V_C Clamping Voltage - Peak voltage measured across the TVS at a specified I_{PPM} (peak impulse current)

I_R Reverse Leakage Current - Current measured at V_R

V_F Forward Voltage Drop for Uni-directional

1.5SMB Series

Surface Mount – 1500W

Ratings and Characteristic Curves ($T_A=25^\circ\text{C}$ unless otherwise noted)

Figure 1 - TVS Transients Clamping Waveform

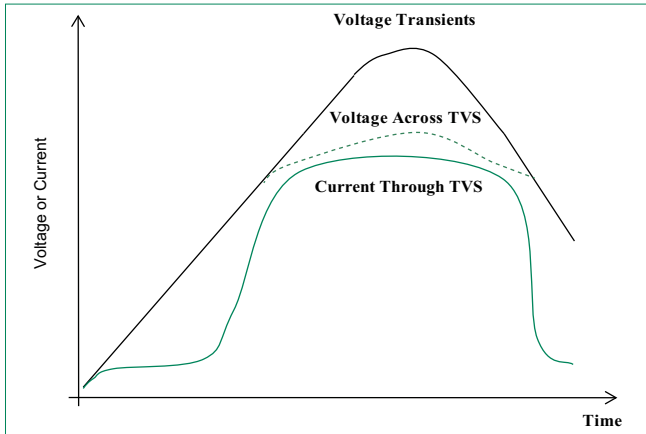

Figure 2 - Peak Pulse Power Rating Curve

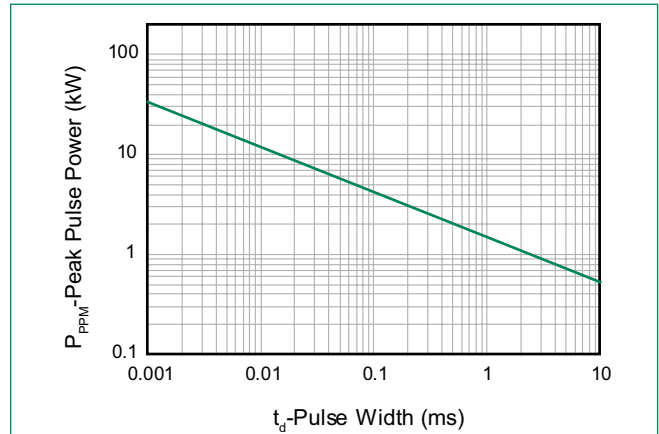

Figure 3 - Peak Pulse Power Derating Curve

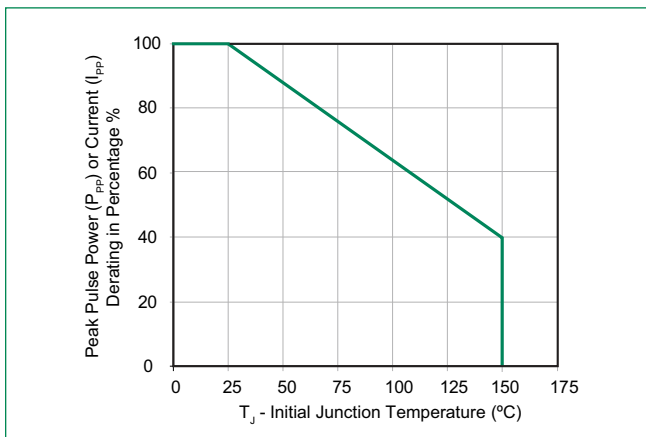

Figure 4 - Pulse Waveform

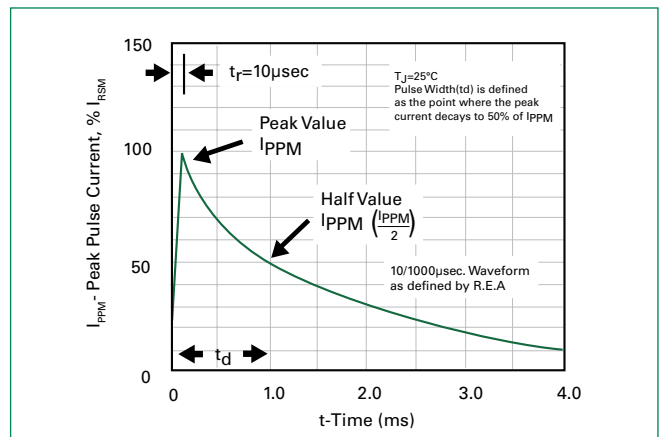

Figure 5 - Typical Junction Capacitance

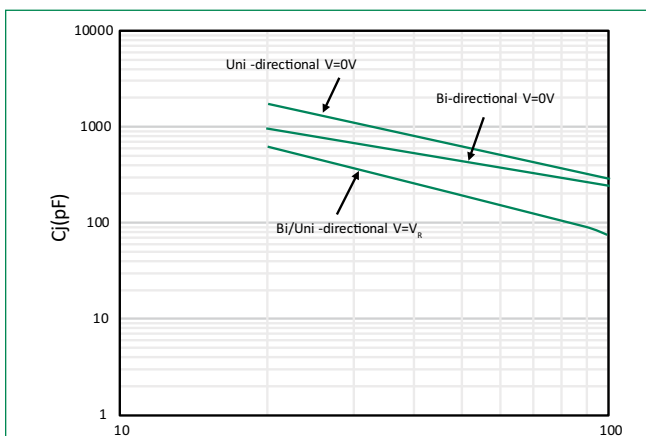
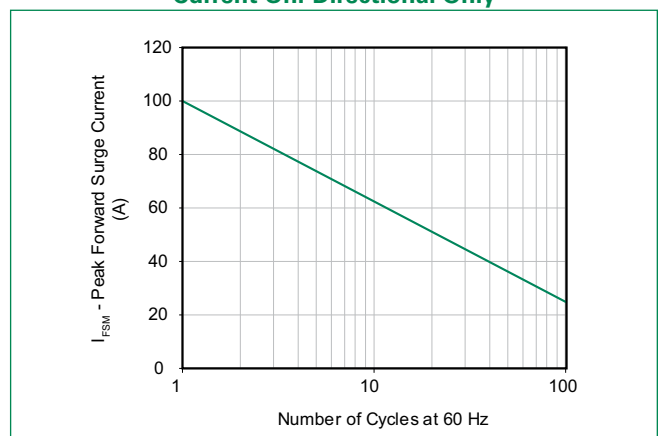

Figure 6 - Maximum Non-Repetitive Peak Forward Surge Current Uni-Directional Only



1.5SMB Series

Surface Mount – 1500W

Figure 7 - Typical Transient Thermal Impedance

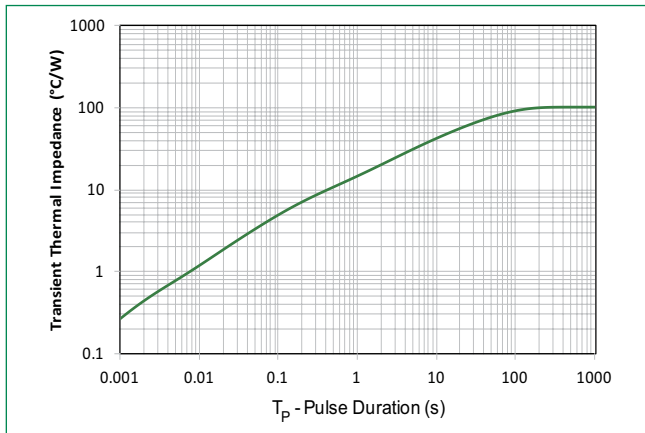
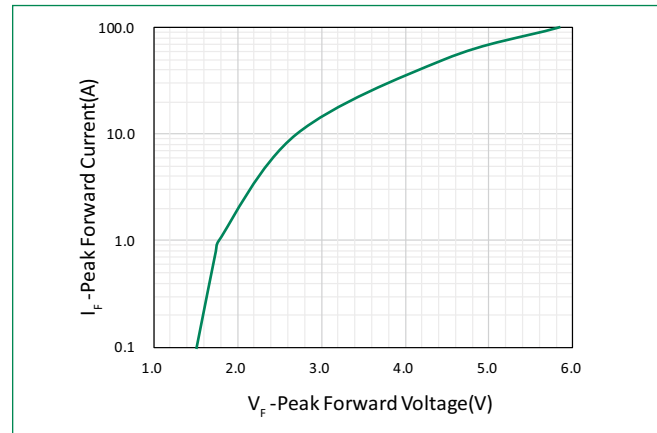
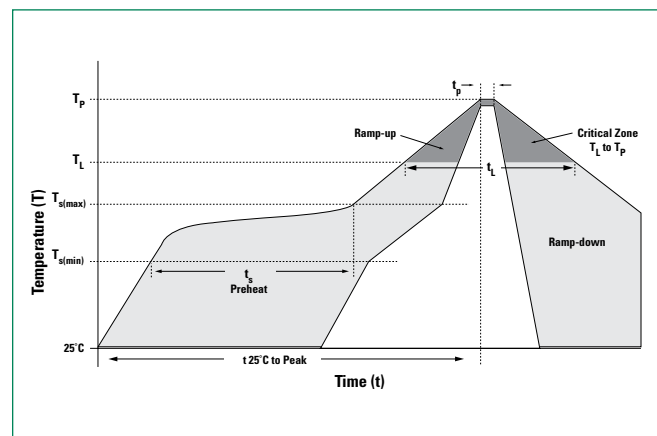

Figure 8 - Peak Forward Voltage Drop vs Peak Forward Current (Typical Values)



Soldering Parameters

Reflow Condition		Lead-free assembly
Pre Heat	- Temperature Min ($T_{s(min)}$)	150°C
	- Temperature Max ($T_{s(max)}$)	200°C
	- Time (min to max) (t_c)	60 – 180 secs
Average ramp up rate (Liquidus Temp (T_L) to peak)		3°C/second max
$T_{s(max)}$ to T_A - Ramp-up Rate		3°C/second max
Reflow	- Temperature (T_L) (Liquidus)	217°C
	- Time (min to max) (t_L)	60 – 150 seconds
Peak Temperature (T_p)		260 ^{+0/-5} °C
Time within 5°C of actual peak Temperature (t_p)		20 – 40 seconds
Ramp-down Rate		6°C/second max
Time 25°C to peak Temperature (T_p)		8 minutes Max.
Do not exceed		260°C



Physical Specifications

Weight	0.003 ounce, 0.093 grams
Case	JEDEC DO214AA. Molded plastic body over glass passivated junction
Polarity	Color band denotes cathode except Bidirectional.
Terminal	Matte Tin-plated leads, Solderable per JESD22-B102

Environmental Specifications

High Temp. Storage	JESD22-A103
HTRB	JESD22-A108
Temperature Cycling	JESD22-A104
MSL	JEDEC-J-STD-020, Level 1
H3TRB	JESD22-A101
RSH	JESD22-A111

1.5SMB Series

Surface Mount – 1500W

Dimensions

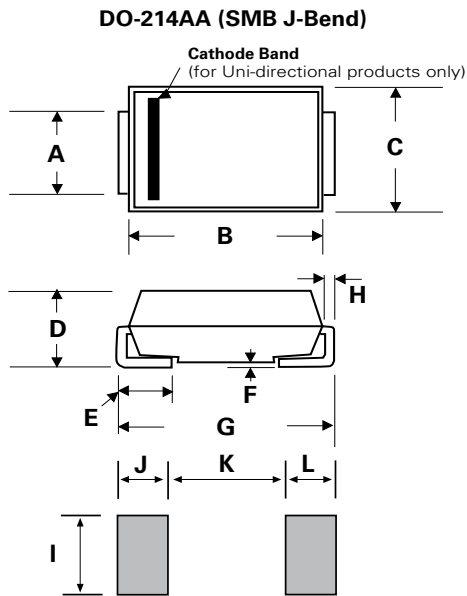

Dimensions	Inches		Millimeters	
	Min	Max	Min	Max
A	0.077	0.086	1.950	2.200
B	0.160	0.180	4.060	4.570
C	0.130	0.155	3.300	3.940
D	0.084	0.096	2.130	2.440
E	0.030	0.060	0.760	1.520
F	-	0.008	-	0.203
G	0.205	0.220	5.210	5.590
H	0.006	0.012	0.152	0.305
I	0.089	-	2.260	-
J	0.085	-	2.160	-
K	-	0.107	-	2.740
L	0.085	-	2.160	-

Part Numbering System

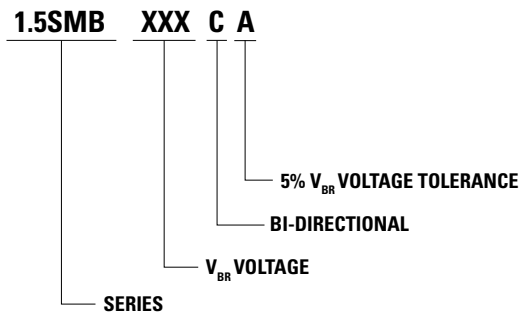

Part Marking System

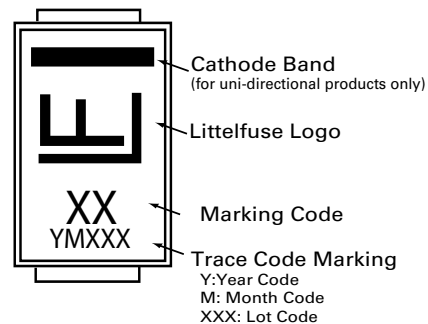

Packaging

Part number	Component Package	Quantity	Packaging Option	Packaging Specification
1.5SMBxxxXX	DO-214AA	3000	Tape & Reel - 12mm tape/13" reel	EIA STD RS-481

1.5SMB Series

Surface Mount – 1500W

Tape and Reel Specification

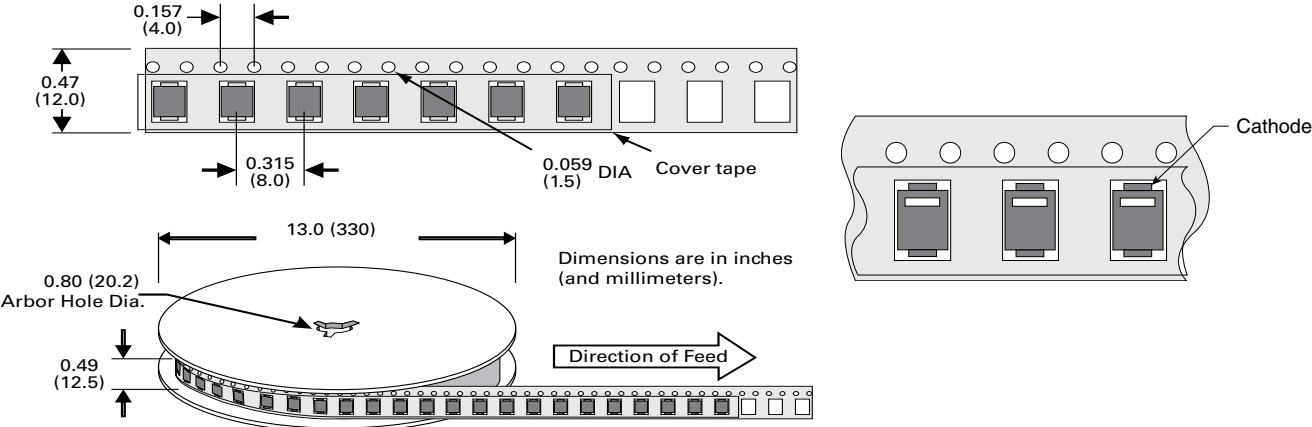

Disclaimer Notice - Information furnished is believed to be accurate and reliable. However, users should independently evaluate the suitability of and test each product selected for their own applications. Littelfuse products are not designed for, and may not be used in, all applications. Read complete Disclaimer Notice at <http://www.littelfuse.com/disclaimer-electronics>.