

Standard Rectifier Module

$$V_{RRM} = 2 \times 1600 \text{ V}$$

$$I_{FAV} = 210 \text{ A}$$

$$V_F = 1.04 \text{ V}$$


Phase leg

Part number

MDMA210P1600YD



Backside: isolated

 E72873



Features / Advantages:

- Package with DCB ceramic
- Improved temperature and power cycling
- Planar passivated chips
- Very low forward voltage drop
- Very low leakage current

Applications:

- Diode for main rectification
- For single and three phase bridge configurations
- Supplies for DC power equipment
- Input rectifiers for PWM inverter
- Battery DC power supplies
- Field supply for DC motors

Package: Y4

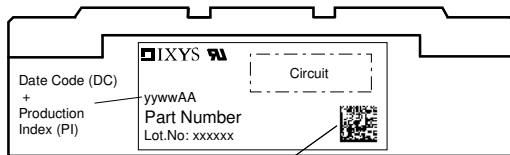
- Isolation Voltage: 4800 V~
- Industry standard outline
- RoHS compliant
- Height: 30 mm
- Base plate: DCB ceramic
- Reduced weight
- Advanced power cycling

Disclaimer Notice

Information furnished is believed to be accurate and reliable. However, users should independently evaluate the suitability of and test each product selected for their own applications. Littelfuse products are not designed for, and may not be used in, all applications. Read complete Disclaimer Notice at www.littelfuse.com/disclaimer-electronics.

| Rectifier | | | | Ratings | | | |
|------------|--|-----------------------------------|---------|------------------------------|------|-------|-------------------|
| Symbol | Definition | Conditions | | min. | typ. | max. | Unit |
| V_{RSM} | max. non-repetitive reverse blocking voltage | | | | | 1700 | V |
| V_{RRM} | max. repetitive reverse blocking voltage | | | | | 1600 | V |
| I_R | reverse current | $V_R = 1600$ V | | $T_{VJ} = 25^\circ\text{C}$ | | 1 | mA |
| | | $V_R = 1600$ V | | $T_{VJ} = 150^\circ\text{C}$ | | 15 | mA |
| V_F | forward voltage drop | $I_F = 210$ A | | $T_{VJ} = 25^\circ\text{C}$ | | 1.13 | V |
| | | $I_F = 420$ A | | | | 1.34 | V |
| | | $I_F = 210$ A | | $T_{VJ} = 125^\circ\text{C}$ | | 1.04 | V |
| | | $I_F = 420$ A | | | | 1.30 | V |
| I_{FAV} | average forward current | $T_C = 100^\circ\text{C}$ | | $T_{VJ} = 150^\circ\text{C}$ | | 210 | A |
| | | rectangular | d = 0.5 | | | | |
| V_{FO} | threshold voltage | | | $T_{VJ} = 150^\circ\text{C}$ | | 0.76 | V |
| r_F | slope resistance | | | | | 1.2 | mΩ |
| | | } for power loss calculation only | | | | | |
| R_{thJC} | thermal resistance junction to case | | | | | 0.17 | K/W |
| R_{thCH} | thermal resistance case to heatsink | | | | 0.09 | | K/W |
| P_{tot} | total power dissipation | | | $T_C = 25^\circ\text{C}$ | | 735 | W |
| I_{FSM} | max. forward surge current | t = 10 ms; (50 Hz), sine | | $T_{VJ} = 45^\circ\text{C}$ | | 6.60 | kA |
| | | t = 8,3 ms; (60 Hz), sine | | $V_R = 0$ V | | 7.13 | kA |
| | | t = 10 ms; (50 Hz), sine | | $T_{VJ} = 150^\circ\text{C}$ | | 5.61 | kA |
| | | t = 8,3 ms; (60 Hz), sine | | $V_R = 0$ V | | 6.06 | kA |
| I^2t | value for fusing | t = 10 ms; (50 Hz), sine | | $T_{VJ} = 45^\circ\text{C}$ | | 217.8 | kA ² s |
| | | t = 8,3 ms; (60 Hz), sine | | $V_R = 0$ V | | 211.5 | kA ² s |
| | | t = 10 ms; (50 Hz), sine | | $T_{VJ} = 150^\circ\text{C}$ | | 157.4 | kA ² s |
| | | t = 8,3 ms; (60 Hz), sine | | $V_R = 0$ V | | 152.8 | kA ² s |
| C_J | junction capacitance | $V_R = 400$ V; f = 1 MHz | | $T_{VJ} = 25^\circ\text{C}$ | | 208 | pF |

| Package Y4 | | | | Ratings | | | |
|---------------|--|----------------------|-------------------------------------|---------|------|------|--|
| Symbol | Definition | Conditions | min. | typ. | max. | Unit | |
| I_{RMS} | RMS current | per terminal | | | 300 | A | |
| T_{VJ} | virtual junction temperature | | -40 | | 150 | °C | |
| T_{op} | operation temperature | | -40 | | 125 | °C | |
| T_{stg} | storage temperature | | -40 | | 125 | °C | |
| Weight | | | | | 150 | g | |
| M_D | mounting torque | | 2.25 | | 2.75 | Nm | |
| M_T | terminal torque | | 4.5 | | 5.5 | Nm | |
| $d_{Spp/APP}$ | creepage distance on surface striking distance through air | terminal to terminal | 14.0 | 10.0 | | mm | |
| $d_{Spb/APb}$ | | terminal to backside | 16.0 | 16.0 | | mm | |
| V_{ISOL} | isolation voltage | t = 1 second | | 4800 | | V | |
| | | t = 1 minute | 50/60 Hz, RMS; $I_{ISOL} \leq 1$ mA | 4000 | | V | |



Data Matrix: part no. (1-19), DC + PI (20-25), lot.no.# (26-31), blank (32), serial no.# (33-36)

Part description

M = Module
 D = Diode
 M = Standard Rectifier
 A = (up to 1800V)
 210 = Current Rating [A]
 P = Phase leg
 1600 = Reverse Voltage [V]
 YD = Y4-M6

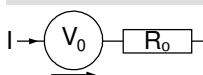
| Ordering | Ordering Number | Marking on Product | Delivery Mode | Quantity | Code No. |
|----------|-----------------|--------------------|---------------|----------|----------|
| Standard | MDMA210P1600YD | MDMA210P1600YD | Box | 6 | 517762 |

| Similar Part | Package | Voltage class |
|----------------|---------|---------------|
| MDMA180P1600YD | Y4-M6 | 1600 |
| MDMA280P1600YD | Y4-M6 | 1600 |

Equivalent Circuits for Simulation

* on die level

$T_{VJ} = 150^\circ\text{C}$



Rectifier

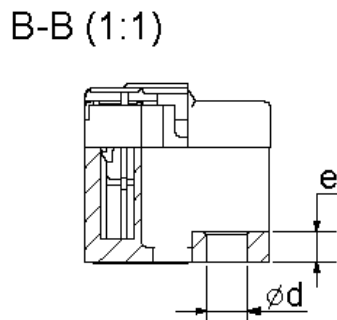
| | | | |
|--------------|--------------------|------|----|
| $V_{0\ max}$ | threshold voltage | 0.76 | V |
| $R_{0\ max}$ | slope resistance * | 0.57 | mΩ |



Outlines Y4



| Dim. | MIN [mm] | MAX [mm] | MIN [inch] | MAX [inch] |
|------|-----------|----------|------------|------------|
| a | 30.0 | 30.6 | 1.181 | 1.205 |
| b | typ. 0.25 | | typ. 0.010 | |
| c | 64.0 | 65.0 | 2.520 | 2.559 |
| d | 6.5 | 7.0 | 0.256 | 0.275 |
| e | 4.9 | 5.1 | 0.193 | 0.201 |
| h | 93.5 | 94.5 | 3.681 | 3.720 |
| i | 79.5 | 80.5 | 3.130 | 3.169 |
| k | 33.4 | 34.0 | 1.315 | 1.339 |
| l | 16.7 | 17.3 | 0.657 | 0.681 |
| m | 22.7 | 23.3 | 0.894 | 0.917 |
| n | 22.7 | 23.3 | 0.894 | 0.917 |
| o | 14.0 | 15.0 | 0.551 | 0.591 |
| p | typ. 10.5 | | typ. 0.413 | |



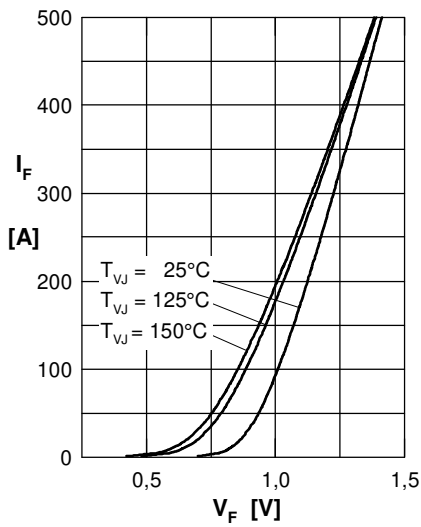
Rectifier


Fig. 1 Forward current versus voltage drop per diode

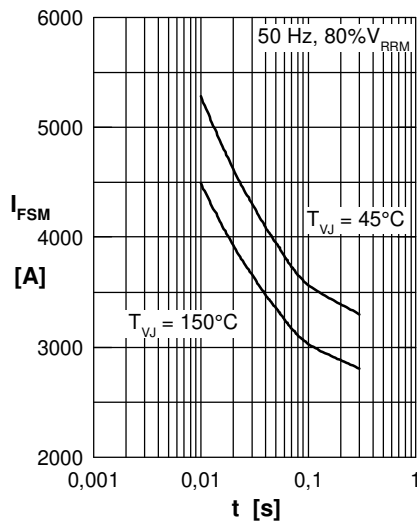


Fig. 2 Surge overload current vs. time per diode

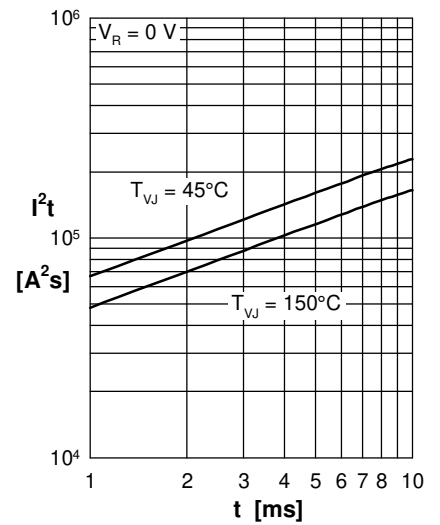
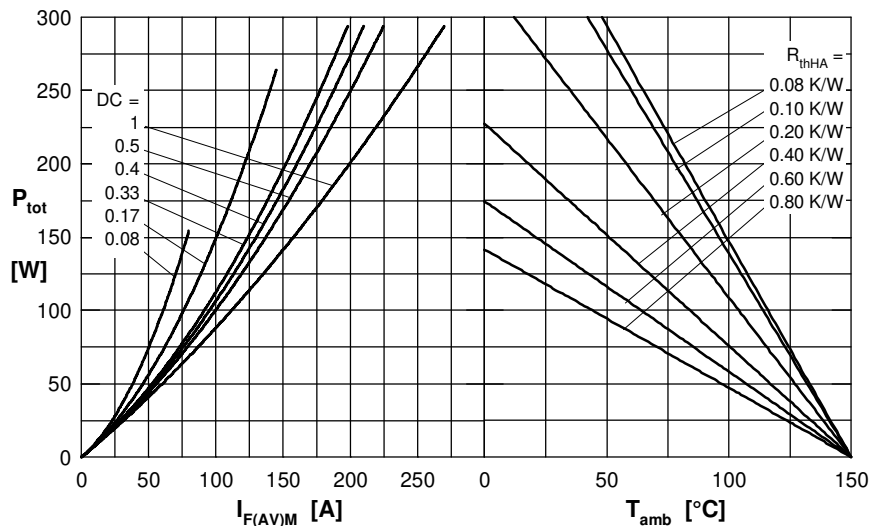

 Fig. 3 I^2t versus time per diode


Fig. 4 Power dissipation vs. forward current and ambient temperature per diode

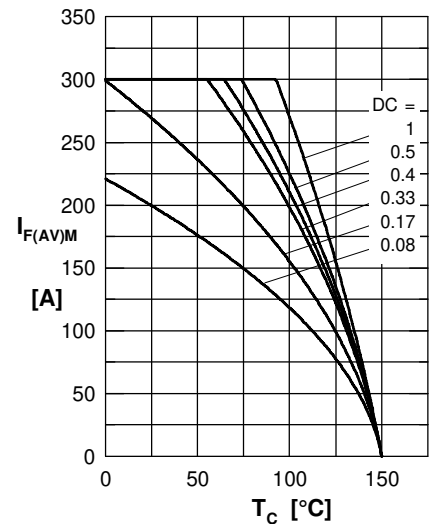


Fig. 5 Max. forward current vs. case temperature per diode

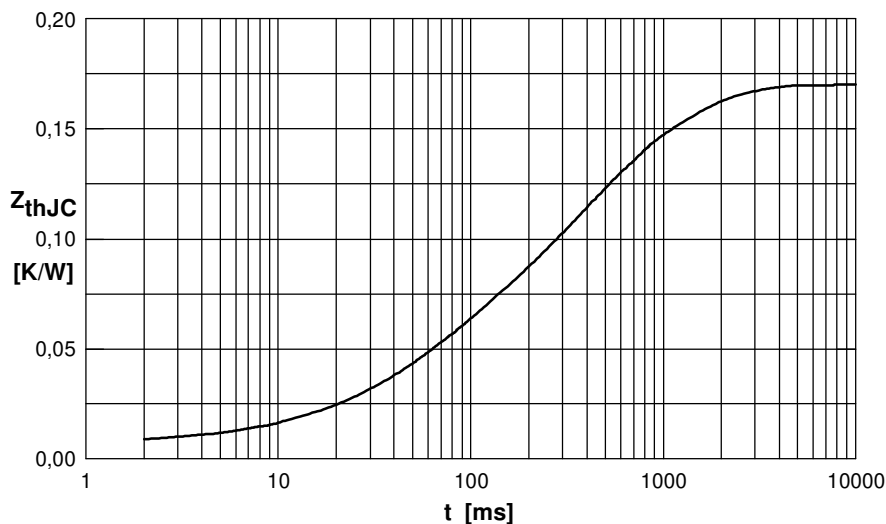


Fig. 6 Transient thermal impedance junction to case vs. time per diode

 Constants for Z_{thJC} calculation:

| i | R_{thi} (K/W) | t_i (s) |
|---|-----------------|-----------|
| 1 | 0.007 | 0.0005 |
| 2 | 0.036 | 0.0500 |
| 3 | 0.072 | 0.3000 |
| 4 | 0.055 | 1.0000 |