

# AQ4020 Series 2.5pF, 30A Discrete TVS Diode



## Description

The AQ4020 components integrate low capacitance steering diodes with one or two avalanche breakdown diodes for unidirectional or bidirectional protection, respectively, to protect against ESD and lightning induced surge events. These components can safely absorb up to 30A per IEC 61000-4-5 2<sup>nd</sup> edition ( $t_p=8/20\mu s$ ) without performance degradation and a minimum  $\pm 30kV$  ESD per IEC 61000-4-2 International Standard. The low loading capacitance and high surge capability make it ideal for protecting telecommunication ports such as Ethernet and other high speed data interfaces.

## Pinout



## Features

- ESD, IEC 61000-4-2,  $\pm 30kV$  contact,  $\pm 30kV$  air
- EFT, IEC 61000-4-4, 40A (5/50ns)
- Lightning, IEC 61000-4-5 2<sup>nd</sup> edition, 30A ( $t_p=8/20\mu s$ )
- Low capacitance of 2.5pF (@  $V_R=0V$ )
- Low leakage current of 0.1 $\mu A$  at 3.3V
- Unidirectional and bidirectional configuration
- Small SOD323 package fits 0805 footprints
- AEC-Q101 Qualified
- Moisture Sensitivity Level(MSL -1)
- Halogen free, lead free and RoHS compliant

## Functional Block Diagram

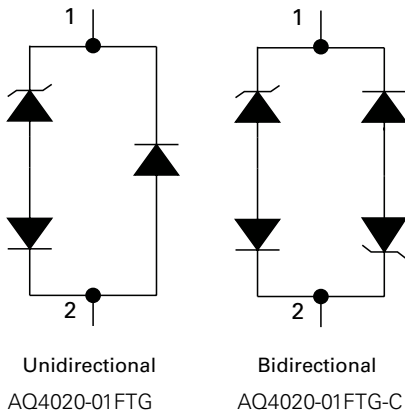

## Applications

- 10/100/1000 Ethernet
- T1/E1/T3/E3
- USB 1.1/2.0
- Power Ports
- Computers and Peripherals
- Instrumentation
- Medical Equipment
- CAN Bus protection
- Automotive applications

Life Support Note:

**Not Intended for Use in Life Support or Life Saving Applications**

The products shown herein are not designed for use in life sustaining or life saving applications unless otherwise expressly indicated.

### Absolute Maximum Ratings

Symbol	Parameter	Value	Units
$I_{PP}$	Peak Current ( $t_p=8/20\mu s$ )	30	A
$P_{PK}$	Peak Pulse Power ( $t_p=8/20\mu s$ )	735	W
$T_{OP}$	Operating Temperature	-40 to 150	°C
$T_{STOR}$	Storage Temperature	-55 to 150	°C

**Notes:** Stresses above those listed in "Absolute Maximum Ratings" may cause permanent damage to the component. This is a stress only rating and operation of the component at these or any other conditions above those indicated in the operational sections of this specification is not implied.

### Electrical Characteristics ( $T_{OP}=25^\circ C$ )

Parameter	Symbol	Test Conditions	Min	Typ	Max	Units
Breakdown Voltage	$V_{BD}$	$I_R=2\mu A$	3.5			V
Reverse Standoff Voltage	$V_{RWM}$	$I_R\leq 1\mu A$			3.3	V
Leakage Current	$I_{LEAK}$	$V_R=3.3V$		0.1	0.5	$\mu A$
Clamp Voltage <sup>1</sup>	$V_C$	$I_{PP}=1A, t_p=8/20\mu s, Fwd$		6.6		V
		$I_{PP}=10A, t_p=8/20\mu s, Fwd$		14.2		V
		$I_{PP}=30A, t_p=8/20\mu s, Fwd$		24.5		V
Dynamic Resistance <sup>2</sup>	$R_{DYN}$	TLP, $t_p=100ns, I/O$ to GND		0.4		$\Omega$
ESD Withstand Voltage <sup>1</sup>	$V_{ESD}$	IEC 61000-4-2 (Contact Discharge)	$\pm 30$			kV
		IEC 61000-4-2 (Air Discharge)	$\pm 30$			kV
Diode Capacitance <sup>1</sup>	$C_D$	Reverse Bias=0V, $f=1MHz$		2.5		pF

**Note:**

- Parameter is guaranteed by design and/or component characterization.
- Transmission Line Pulse (TLP) with 100ns width, 2ns rise time, and average window  $t_1=70ns$  to  $t_2=90ns$

### 8/20 $\mu s$ Pulse Waveform

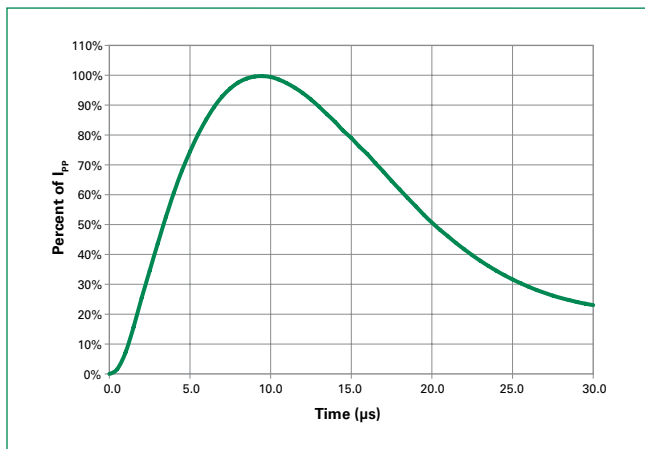

### Normalized Capacitance vs. Bias Voltage

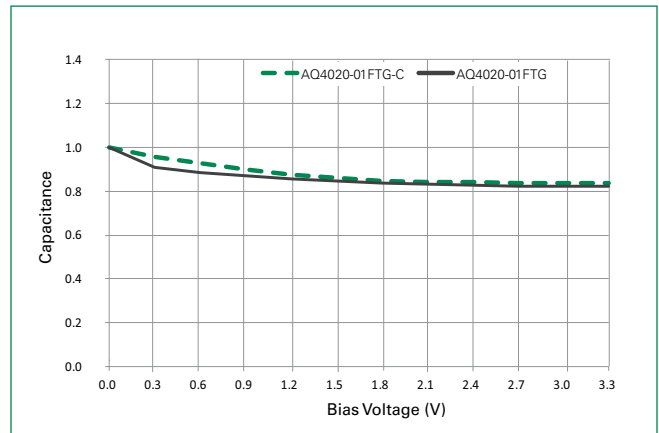

**Postive Transmission Line Pulsing (TLP) Plot**

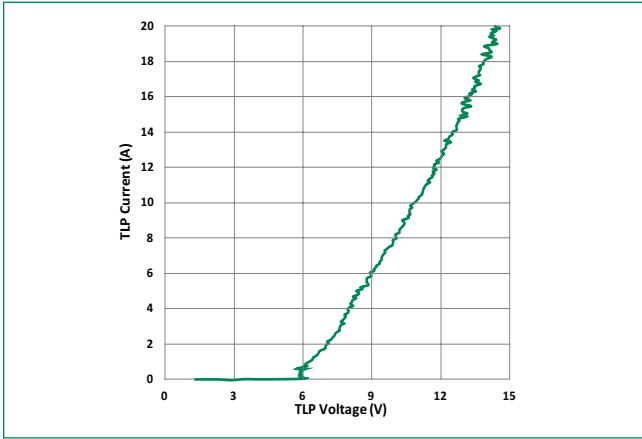

**Negative Transmission Line Pulsing (TLP) Plot**

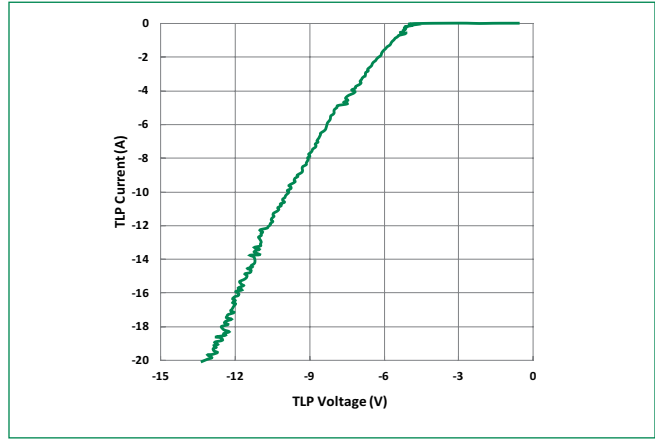

**Clamping Voltage vs.  $I_{pp}$**

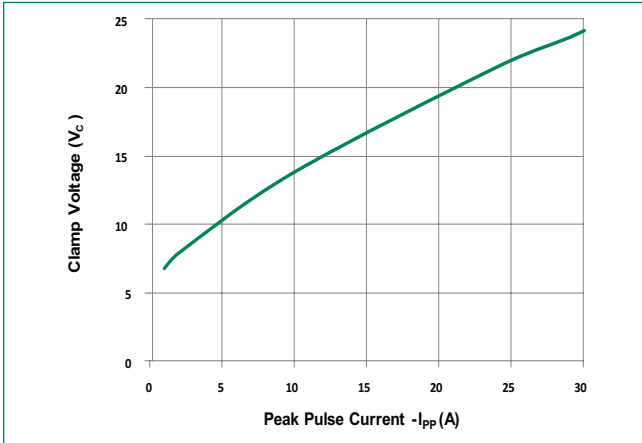

**Soldering Parameters**

<b>Reflow Condition</b>		Pb – Free assembly
<b>Pre Heat</b>	- Temperature Min ( $T_{s(min)}$ )	150°C
	- Temperature Max ( $T_{s(max)}$ )	200°C
	- Time (min to max) ( $t_s$ )	60 – 180 secs
<b>Average ramp up rate (Liquidus) Temp (<math>T_L</math>) to peak</b>		3°C/second max
<b><math>T_{s(max)}</math> to <math>T_L</math> - Ramp-up Rate</b>		3°C/second max
<b>Reflow</b>	- Temperature ( $T_L$ ) (Liquidus)	217°C
	- Temperature ( $t_L$ )	60 – 150 seconds
<b>Peak Temperature (<math>T_p</math>)</b>		260 <sup>+0/-5</sup> °C
<b>Time within 5°C of actual peak Temperature (<math>t_p</math>)</b>		20 – 40 seconds
<b>Ramp-down Rate</b>		6°C/second max
<b>Time 25°C to peak Temperature (<math>T_p</math>)</b>		8 minutes Max.
<b>Do not exceed</b>		260°C

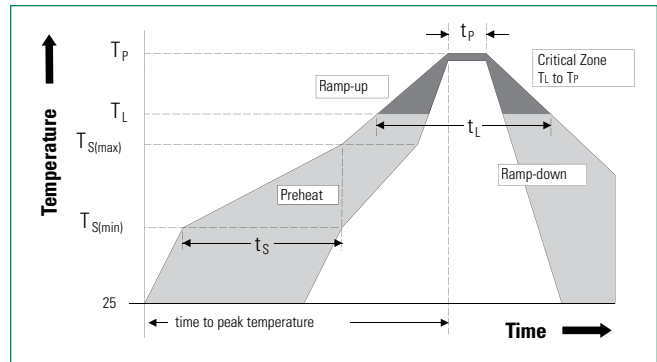

**Part Marking System**

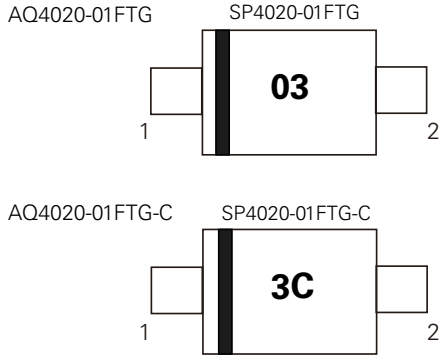

**Product Characteristics**

<b>Lead Plating</b>	Matte tin
<b>Lead Material</b>	Copper Alloy
<b>Lead Coplanarity</b>	0.0004 inches (0.102mm)
<b>Substrate material</b>	Silicon
<b>Body Material</b>	Molded Compound
<b>Flammability</b>	UL Recognized compound meeting flammability rating V-0

**Notes:**

1. All dimensions are in millimeters
2. Dimensions include solder plating.
3. Dimensions are exclusive of mold flash & metal burr.

**Part Numbering System**

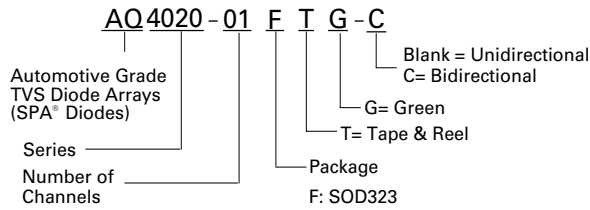

**Ordering Information**

Part Number	Package	Marking	Min. Order Qty.
AQ4020-01FTG	SOD323	03	3000
AQ4020-01FTG-C	SOD323	3C	3000

**Package Dimensions -SOD323**

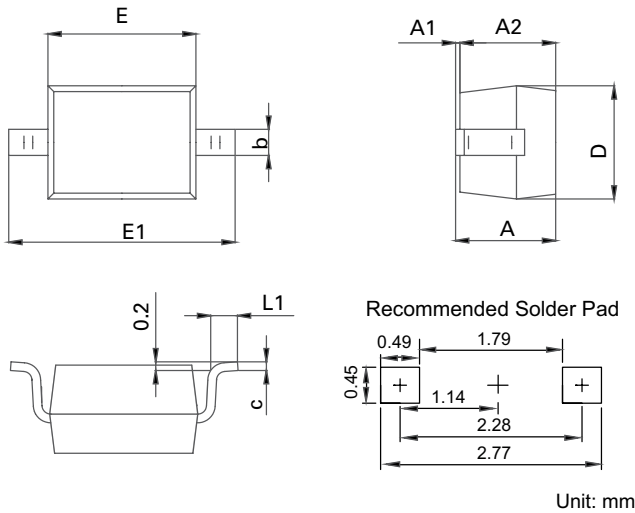

Symbol	SOD323			
	Millimeters		Inches	
	Min	Max	Min	Max
<b>A</b>	0.80	1.00	0.031	0.039
<b>A1</b>	0.00	0.10	0.000	0.004
<b>A2</b>	0.80	0.90	0.031	0.035
<b>b</b>	0.25	0.35	0.010	0.014
<b>c</b>	0.08	0.15	0.003	0.006
<b>D</b>	1.20	1.40	0.047	0.055
<b>E</b>	1.60	1.80	0.063	0.071
<b>E1</b>	2.50	2.70	0.098	0.106
<b>L1</b>	0.25	0.40	0.010	0.016

**Embossed Carrier Tape & Reel Specification – SOD323**

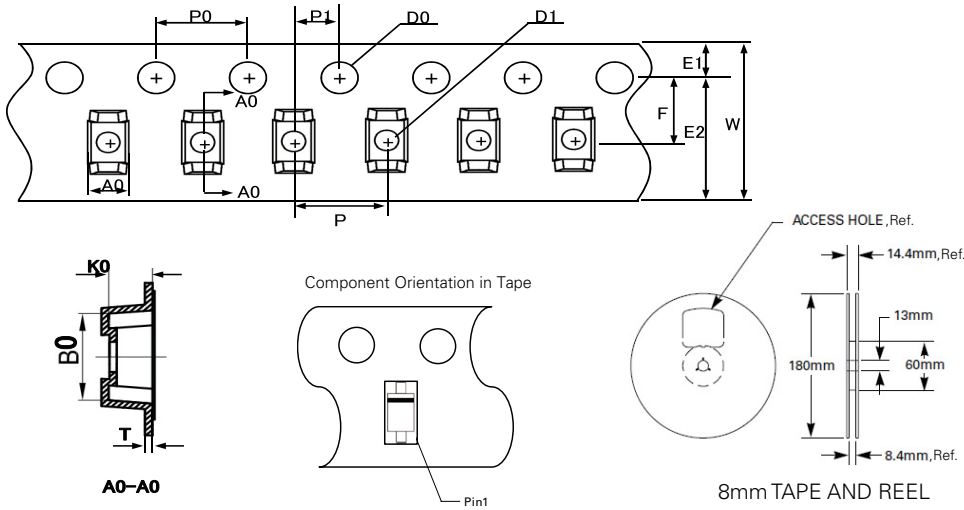

Symbol	Millimeters
<b>A0</b>	1.46+/-0.10
<b>B0</b>	2.90+/-0.10
<b>W</b>	8.0+0.3/-0.10
<b>D0</b>	1.50+0.10
<b>D1</b>	0.45min/1.15max
<b>E1</b>	1.75+/-0.10
<b>E2</b>	-
<b>F</b>	3.50+/-0.10
<b>P0</b>	4.00+/-0.10
<b>P</b>	4.00+/-0.10
<b>P1</b>	2.00+/-0.05
<b>K0</b>	1.25+/-0.10
<b>T</b>	0.254+/-0.02