

SZSMF4L Series

Automotive, Surface Mount 400 W in SOD-123FL



Web Resources



Download ECAD models, order samples, and find technical resources at www.littelfuse.com

Agency Approvals

Agency	Agency File Number
	E128662

Maximum Ratings & Thermal Characteristics

Parameter	Symbol	Value	Unit
Peak Power Dissipation (Note 1) @ $T_L = 25$ °C, Pulse Width = 1 ms	P_{PK}	400	W
DC Power Dissipation @ $T_L = 75$ °C, Measured Zero Lead Length (Note 2) Derate Above 75 °C	P_D	3.85 38.5	W mW/°C
DC Power Dissipation (Note 3) @ $T_A = 25$ °C Derate Above 25 °C	P_D	1 6.67	W mW/°C
Thermal Resistance from Junction-to-Lead	$R_{\theta JL}$	26	°C/W
Thermal Resistance from Junction-to-Ambient	$R_{\theta JA}$	150	°C/W
Forward Surge Current (Note 4) @ $T_A = 25$ °C (For Uni-directional)	I_{FSM}	40	A
Operating and Storage Temperature Range	T_J, T_{STG}	-55 to +175	°C

Stresses exceeding maximum ratings may damage the component. Maximum ratings are stress ratings only. Functional operation above the recommended operating conditions is not implied. Extended exposure to stresses above the recommended operating conditions may affect component reliability.

1. 10 x 1000 μ s, non-repetitive.
2. 1" square copper pad, FR-4 board.
3. FR-4 board, using Littelfuse minimum recommended footprint.
4. 1/2 sine wave (or equivalent square wave), PW = 8.3 ms, duty cycle = 4 pulses per minute maximum.

Description

The SZSMF4L series is designed to protect sensitive systems or components from high voltage, high energy transients. It offers a fast response time, low zener impedance, high surge and excellent clamping capabilities. Because of its small size, it is ideal for use in automotive electronics applications.

Features & Benefits

- Automotive grade, AEC-Q101 qualified and PPAP capable
- Zener transient overvoltage suppressors
- Working peak reverse voltage range 5 V to 78 V for uni-directional and 10 V to 170 V for bi-directional
- Standard zener breakdown voltage range - 6.4 V to 209.0 V for uni-directional and 11.1V to 95.8V for bi-directional
- Peak power: 400 watts @ 1 ms
- Planar chip design with low leakage current performance
- Response time is typically < 1 ns
- Excellent clamping capability
- ESD rating of class 3 (> 16 kV) per human body model
- ESD protection of data lines in accordance with IEC 61000-4-2 30 kV (Air), 30 kV (Contact)
- Compact design in SOD-123FL package
- Lead orientation in tape: cathode lead to sprocket holes
- These components are Pb-free and are RoHS compliant
- $VBR @ T_J = VBR @ 25^\circ C \times (1 + \alpha T \times (T_J - 25))$ (αT : Temperature Coefficient)
- UL recognized as an isolated loop circuit protector to UL 497B
- UL recognized compound meeting flammability rating V-0
- Maximum temperature coefficient specified

Applications

TVS components are ideal for the protection of I/O Interfaces, VCC bus and other vulnerable circuits used in Automotive applications.

Functional Diagram



Bi-directional



Uni-directional

SZSMF4L Series

Automotive, Surface Mount 400 W in SOD-123FL

Electrical Characteristics

Part Number (Uni)	Part Number (Bi)	Marking		Working Peak Reverse Voltage V_{RWM} (V) (Note 4)	Breakdown Voltage V_{BR} (V) @ I_T (Note 5)		Test Current I_T (mA)	Maximum Clamping Voltage V_C @ I_{PP} (V)	Maximum Peak Pulse Current I_{PP} (A)	Maximum Reverse Leakage I_R @ V_R (μ A) (Note 6)	Agency Approval 
		Uni	Bi		Min	Max					
SZSMF4L5.0AT3G	-	QE	-	5.0	6.40	7.00	10	9.2	43.5	50	x
SZSMF4L6.0AT3G	-	QG	-	6.0	6.67	7.37	10	10.3	38.8	50	x
SZSMF4L6.5AT3G	-	QK	-	6.5	7.22	7.98	10	11.2	35.7	40	x
SZSMF4L7.0AT3G	-	QL	-	7.0	7.78	8.60	10	12.0	33.3	40	x
SZSMF4L7.5AT3G	-	QN	-	7.5	8.33	9.21	1	12.9	31.0	30	x
SZSMF4L8.0AT3G	-	QR	-	8.0	8.89	9.83	1	13.6	29.4	5	x
SZSMF4L8.5AT3G	-	QT	-	8.5	9.44	10.40	1	14.4	27.8	5	x
SZSMF4L9.0AT3G	-	QV	-	9.0	10.00	11.10	1	15.4	26.0	2	x
SZSMF4L10AT3G	SZSMF4L10CAT3G	QX	QXC	10	11.10	12.30	1	17.0	23.5	2	x
SZSMF4L11AT3G	SZSMF4L11CAT3G	QZ	QZC	11	12.20	13.50	1	18.2	22.0	2	x
SZSMF4L12AT3G	SZSMF4L12CAT3G	RE	REC	12	13.30	14.70	1	19.9	20.1	1	x
SZSMF4L13AT3G	SZSMF4L13CAT3G	RG	RGC	13	14.40	15.90	1	21.5	18.6	1	x
SZSMF4L14AT3G	SZSMF4L14CAT3G	RH	RHC	14	15.60	17.20	1	23.2	17.2	0.5	x
SZSMF4L15AT3G	SZSMF4L15CAT3G	RM	RMC	15	16.70	18.50	1	24.4	16.4	0.5	x
SZSMF4L16AT3G	SZSMF4L16CAT3G	RP	RPC	16	17.80	19.70	1	26.0	15.4	0.5	x
SZSMF4L17AT3G	SZSMF4L17CAT3G	RR	RRC	17	18.90	20.90	1	27.6	14.5	0.5	x
SZSMF4L18AT3G	SZSMF4L18CAT3G	RT	RTC	18	20.00	22.10	1	29.2	13.7	0.5	x
SZSMF4L20AT3G	SZSMF4L20CAT3G	RV	RVC	20	22.20	24.50	1	32.4	12.3	0.5	x
SZSMF4L22AT3G	SZSMF4L22CAT3G	RX	RXC	22	24.40	26.90	1	35.5	11.3	0.5	x
SZSMF4L24AT3G	SZSMF4L24CAT3G	RZ	RZC	24	26.70	29.50	1	38.9	10.3	0.5	x
SZSMF4L26AT3G	SZSMF4L26CAT3G	SE	SEC	26	28.90	31.90	1	42.1	9.5	0.5	x
SZSMF4L28AT3G	SZSMF4L28CAT3G	SG	SGC	28	31.10	34.40	1	45.4	8.8	0.5	x
SZSMF4L30AT3G	SZSMF4L30CAT3G	SK	SKC	30	33.30	36.80	1	48.4	8.3	0.5	x
SZSMF4L33AT3G	SZSMF4L33CAT3G	SM	SMC	33	36.70	40.60	1	53.3	7.5	0.5	x
SZSMF4L36AT3G	SZSMF4L36CAT3G	SP	SPC	36	40.00	44.20	1	58.1	6.9	0.5	x
SZSMF4L40AT3G	SZSMF4L40CAT3G	SR	SRC	40	44.40	49.10	1	64.5	6.2	0.5	x
SZSMF4L43AT3G	SZSMF4L43CAT3G	ST	STC	43	47.80	52.80	1	69.4	5.8	0.5	x
SZSMF4L45AT3G	SZSMF4L45CAT3G	SV	SVC	45	50.00	55.30	1	72.7	5.5	0.5	x
SZSMF4L48AT3G	SZSMF4L48CAT3G	SX	SXC	48	53.30	58.90	1	77.4	5.2	0.5	x
SZSMF4L51AT3G	SZSMF4L51CAT3G	SZ	SZC	51	56.70	62.70	1	82.4	4.9	0.5	x
SZSMF4L54AT3G	SZSMF4L54CAT3G	TE	TEC	54	60.00	66.30	1	87.1	4.6	0.5	x
SZSMF4L58AT3G	SZSMF4L58CAT3G	TG	TGC	58	64.40	71.20	1	93.6	4.3	0.5	x
SZSMF4L60AT3G	SZSMF4L60CAT3G	TI	TIC	60	66.70	73.70	1	96.8	4.1	0.5	x
SZSMF4L64AT3G	SZSMF4L64CAT3G	TM	TMC	64	71.10	78.60	1	103.0	3.9	0.5	x
SZSMF4L70AT3G	SZSMF4L70CAT3G	TP	TPC	70	77.80	86.00	1	113.0	3.5	0.5	x
SZSMF4L75AT3G	SZSMF4L75CAT3G	TR	TRC	75	83.30	92.10	1	121.0	3.3	0.5	x
SZSMF4L78AT3G	SZSMF4L78CAT3G	TT	TTC	78	86.70	95.80	1	126.0	3.2	0.5	x
SZSMF4L85AT3G	-	TV	-	85	94.40	104.0	1	137.0	2.9	0.5	-
SZSMF4L90AT3G	-	TX	-	90	100.0	111.0	1	146.0	2.8	0.5	-
SZSMF4L100AT3G	-	TZ	-	100	111.0	123.0	1	162.0	2.5	0.5	-
SZSMF4L110AT3G	-	VE	-	110	122.0	135.0	1	177.0	2.3	0.5	-
SZSMF4L120AT3G	-	VG	-	120	133.0	147.0	1	193.0	2.1	0.5	-
SZSMF4L130AT3G	-	VK	-	130	144.0	159.0	1	209.0	1.9	0.5	-
SZSMF4L150AT3G	-	VM	-	150	167.0	185.0	1	243.0	1.7	0.5	-
SZSMF4L160AT3G	-	VP	-	160	178.0	197.0	1	259.0	1.6	0.5	-
SZSMF4L170AT3G	-	VR	-	170	189.0	209.0	1	275.0	1.5	0.5	-

SZSMF4L Series

Automotive, Surface Mount 400 W in SOD-123FL

Electrical Characteristics

Part Number (Uni)	Part Number (Bi)	Marking		Working Peak Reverse Voltage V_{RWM} (V) (Note 4)	Breakdown Voltage V_{BR} (V) @ I_T (Note 5)		Test Current I_T (mA)	Maximum Clamping Voltage V_C @ I_{PP} (V)	Maximum Peak Pulse Current I_{PP} (A)	Maximum Reverse Leakage I_R @ V_R (μ A) (Note 6)	Agency Approval 
		Uni	Bi		Min	Max					
SZSMF4L5.0AT1G	-	QE	-	5.0	6.40	7.00	10	9.2	43.5	50	x
SZSMF4L6.0AT1G	-	QG	-	6.0	6.67	7.37	10	10.3	38.8	50	x
SZSMF4L6.5AT1G	-	QK	-	6.5	7.22	7.98	10	11.2	35.7	40	x
SZSMF4L7.0AT1G	-	QL	-	7.0	7.78	8.60	10	12.0	33.3	40	x
SZSMF4L7.5AT1G	-	QN	-	7.5	8.33	9.21	1	12.9	31.0	30	x
SZSMF4L8.0AT1G	-	QR	-	8.0	8.89	9.83	1	13.6	29.4	5	x
SZSMF4L8.5AT1G	-	QT	-	8.5	9.44	10.40	1	14.4	27.8	5	x
SZSMF4L9.0AT1G	-	QV	-	9.0	10.00	11.10	1	15.4	26.0	2	x
SZSMF4L10AT1G	SZSMF4L10CAT1G	QX	QXC	10	11.10	12.30	1	17.0	23.5	2	x
SZSMF4L11AT1G	SZSMF4L11CAT1G	OZ	QZC	11	12.20	13.50	1	18.2	22.0	2	x
SZSMF4L12AT1G	SZSMF4L12CAT1G	RE	REC	12	13.30	14.70	1	19.9	20.1	1	x
SZSMF4L13AT1G	SZSMF4L13CAT1G	RG	RGC	13	14.40	15.90	1	21.5	18.6	1	x
SZSMF4L14AT1G	SZSMF4L14CAT1G	RH	RHC	14	15.60	17.20	1	23.2	17.2	0.5	x
SZSMF4L15AT1G	SZSMF4L15CAT1G	RM	RMC	15	16.70	18.50	1	24.4	16.4	0.5	x
SZSMF4L16AT1G	SZSMF4L16CAT1G	RP	RPC	16	17.80	19.70	1	26.0	15.4	0.5	x
SZSMF4L17AT1G	SZSMF4L17CAT1G	RR	RRC	17	18.90	20.90	1	27.6	14.5	0.5	x
SZSMF4L18AT1G	SZSMF4L18CAT1G	RT	RTC	18	20.00	22.10	1	29.2	13.7	0.5	x
SZSMF4L20AT1G	SZSMF4L20CAT1G	RV	RVC	20	22.20	24.50	1	32.4	12.3	0.5	x
SZSMF4L22AT1G	SZSMF4L22CAT1G	RX	RXC	22	24.40	26.90	1	35.5	11.3	0.5	x
SZSMF4L24AT1G	SZSMF4L24CAT1G	RZ	RZC	24	26.70	29.50	1	38.9	10.3	0.5	x
SZSMF4L26AT1G	SZSMF4L26CAT1G	SE	SEC	26	28.90	31.90	1	42.1	9.5	0.5	x
SZSMF4L28AT1G	SZSMF4L28CAT1G	SG	SGC	28	31.10	34.40	1	45.4	8.8	0.5	x
SZSMF4L30AT1G	SZSMF4L30CAT1G	SK	SKC	30	33.30	36.80	1	48.4	8.3	0.5	x
SZSMF4L33AT1G	SZSMF4L33CAT1G	SM	SMC	33	36.70	40.60	1	53.3	7.5	0.5	x
SZSMF4L36AT1G	SZSMF4L36CAT1G	SP	SPC	36	40.00	44.20	1	58.1	6.9	0.5	x
SZSMF4L40AT1G	SZSMF4L40CAT1G	SR	SRC	40	44.40	49.10	1	64.5	6.2	0.5	x
SZSMF4L43AT1G	SZSMF4L43CAT1G	ST	STC	43	47.80	52.80	1	69.4	5.8	0.5	x
SZSMF4L45AT1G	SZSMF4L45CAT1G	SV	SVC	45	50.00	55.30	1	72.7	5.5	0.5	x
SZSMF4L48AT1G	SZSMF4L48CAT1G	SX	SXC	48	53.30	58.90	1	77.4	5.2	0.5	x
SZSMF4L51AT1G	SZSMF4L51CAT1G	SZ	SZC	51	56.70	62.70	1	82.4	4.9	0.5	x
SZSMF4L54AT1G	SZSMF4L54CAT1G	TE	TEC	54	60.00	66.30	1	87.1	4.6	0.5	x
SZSMF4L58AT1G	SZSMF4L58CAT1G	TG	TGC	58	64.40	71.20	1	93.6	4.3	0.5	x
SZSMF4L60AT1G	SZSMF4L60CAT1G	TI	TIC	60	66.70	73.70	1	96.8	4.1	0.5	x
SZSMF4L64AT1G	SZSMF4L64CAT1G	TM	TMC	64	71.10	78.60	1	103.0	3.9	0.5	x
SZSMF4L70AT1G	SZSMF4L70CAT1G	TP	TPC	70	77.80	86.00	1	113.0	3.5	0.5	x
SZSMF4L75AT1G	SZSMF4L75CAT1G	TR	TRC	75	83.30	92.10	1	121.0	3.3	0.5	x
SZSMF4L78AT1G	SZSMF4L78CAT1G	TT	TTC	78	86.70	95.80	1	126.0	3.2	0.5	x
SZSMF4L85AT1G	-	TV	-	85	94.40	104.0	1	137.0	2.9	0.5	-
SZSMF4L90AT1G	-	TX	-	90	100.0	111.0	1	146.0	2.8	0.5	-
SZSMF4L100AT1G	-	TZ	-	100	111.0	123.0	1	162.0	2.5	0.5	-
SZSMF4L110AT1G	-	VE	-	110	122.0	135.0	1	177.0	2.3	0.5	-
SZSMF4L120AT1G	-	VG	-	120	133.0	147.0	1	193.0	2.1	0.5	-
SZSMF4L130AT1G	-	VK	-	130	144.0	159.0	1	209.0	1.9	0.5	-
SZSMF4L150AT1G	-	VM	-	150	167.0	185.0	1	243.0	1.7	0.5	-
SZSMF4L160AT1G	-	VP	-	160	178.0	197.0	1	259.0	1.6	0.5	-
SZSMF4L170AT1G	-	VR	-	170	189.0	209.0	1	275.0	1.5	0.5	-

4. A transient suppressor is normally selected according to the working peak reverse voltage (V_{RWM}), which should be equal to or greater than the DC or continuous peak operating voltage level.

5. V_{BR} measured at pulse test current I_T at an ambient temperature of 25 °C.

6. For bidirectional type having V_R of 10 volts and less, the I_R limit is double.

SZSMF4L Series

Automotive, Surface Mount 400 W in SOD-123FL

I-V Curve Characteristics ($T_A = 25\text{ }^\circ\text{C}$ unless otherwise noted, $V_F = 3.5\text{ V Max. @ } I_F = 30\text{ A}$)* For Uni-directional

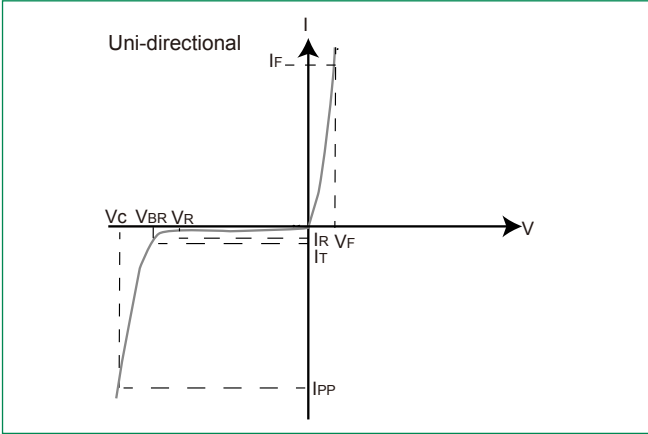

Symbol	Parameter
I_{PP}	Maximum Reverse Peak Pulse Current
V_C	Clamping Voltage @ I_{PP}
V_{RWM}	Working Peak Reverse Voltage
I_R	Maximum Reverse Leakage Current @ V_{RWM}
V_{BR}	Breakdown Voltage @ I_T
I_T	Breakdown Current Current
V_F	Forward Voltage @ I_F
I_F	Forward Current

*1/2 sine wave (or equivalent square wave), PW = 8.3 ms, non-repetitive duty cycle.

I-V Curve Characteristics ($T_A = 25\text{ }^\circ\text{C}$ unless otherwise noted) For Bi-directional

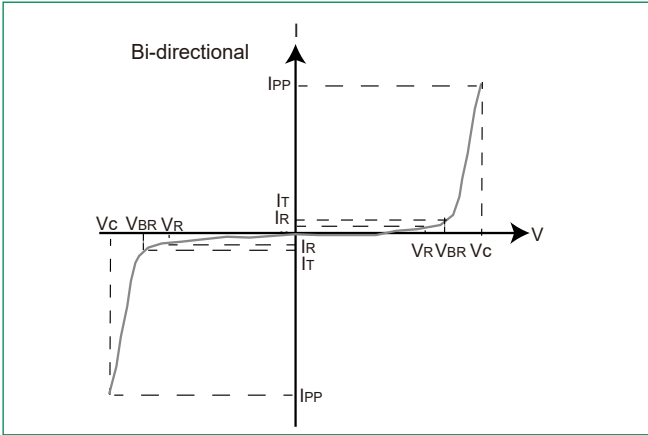

Symbol	Parameter
I_{PP}	Maximum Reverse Peak Pulse Current
V_C	Clamping Voltage @ I_{PP}
V_{RWM}	Working Peak Reverse Voltage
I_R	Maximum Reverse Leakage Current @ V_{RWM}
V_{BR}	Breakdown Voltage @ I_T
I_T	Breakdown Current Current

SZSMF4L Series

Automotive, Surface Mount 400 W in SOD-123FL

Figure 1. Pulse Rating Curve

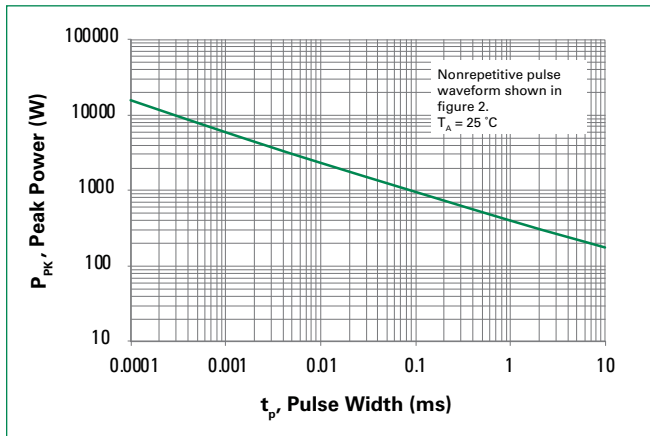

Figure 2. 10/1000 μ s Pulse Waveform

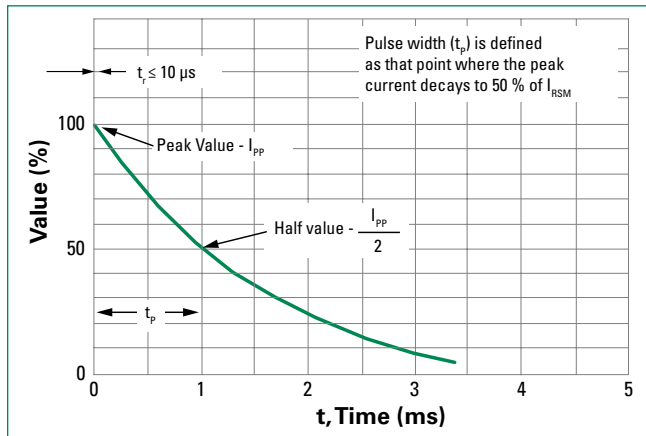

Figure 3. Typical Junction Capacitance vs. Bias Voltage

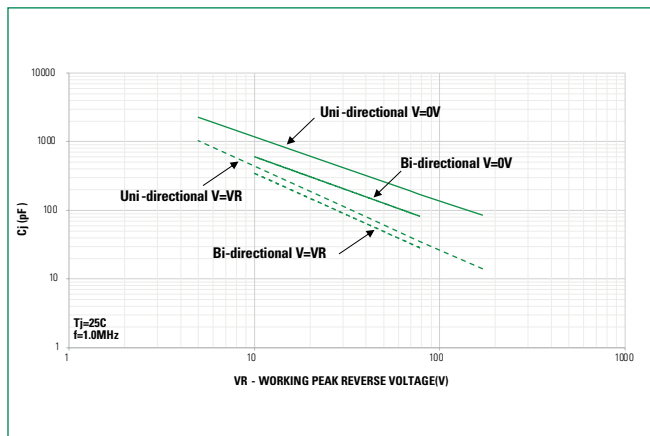
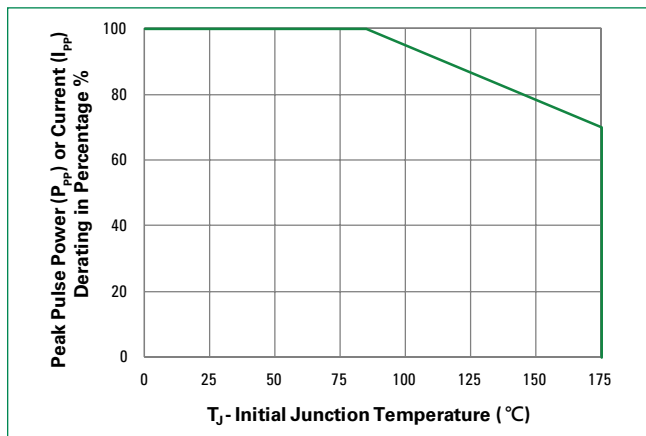

Figure 4. Surge Derating Curve



SZSMF4L Series

Automotive, Surface Mount 400 W in SOD-123FL

Soldering Parameters

Reflow Condition		Lead-free assembly
Pre Heat	- Temperature Min ($T_{s(min)}$)	150 °C
	- Temperature Max ($T_{s(max)}$)	200 °C
	- Time (min to max) (t_s)	60 – 120 seconds
Average Ramp Up Rate (Liquidus Temp (T_L) to Peak		3 °C/second max
$T_{s(max)}$ to T_L - Ramp-up Rate		3 °C/second max
Reflow	- Temperature (T_L) (Liquidus)	217 °C
	- Time (min to max) (t_s)	60 – 150 seconds
Peak Temperature (T_p)		260 ^{+0/-5} °C
Time within 5 °C of Actual Peak Temperature (t_p)		30 seconds max
Ramp-down Rate		6 °C/second max
Time 25 °C to Peak Temperature (T_p)		8 minutes max
Do Not Exceed		260 °C

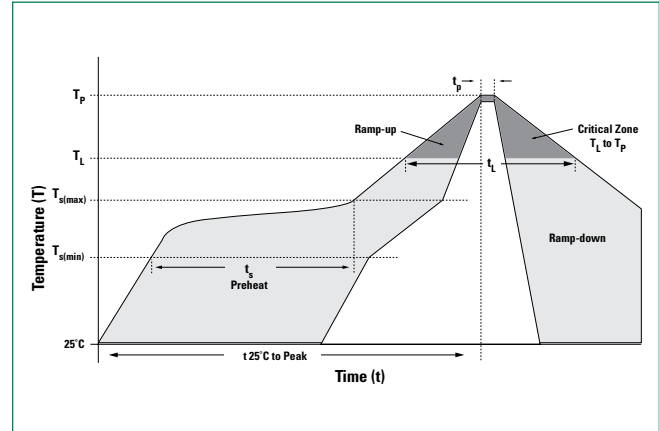

Physical Specifications

Weight	0.006 ounce, 0.0171 grams
Case	JEDEC SOD-123FL
Polarity	Color band denotes cathode for unidirectional components
Terminal	Matte Tin-plated leads, solderable per JESD22-B102

Environmental Specifications

High temperature storage	JESD22-A103
HTRB	JESD22-A108
Temperature cycling	JESD22-A104
MSL	JEDEC-J-STD-020, Level 1
H3TRB	JESD22-A101
RSH	JESD22-A111

Dimensions

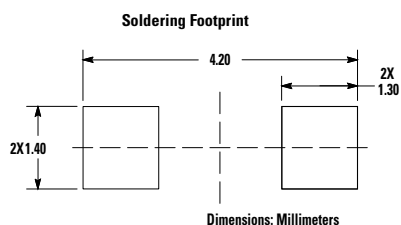
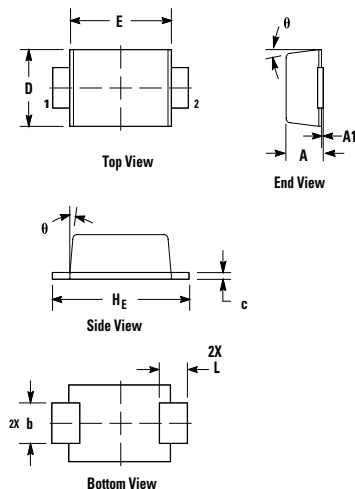

Dimensions: Millimeters

Dim	Millimeters			Inches		
	Min	Nom	Max	Min	Nom	Max
A	1.20	1.30	1.40	0.047	0.051	0.055
A1	0.00	0.05	0.10	0	0.002	0.004
b	1.10	1.20	1.30	0.043	0.047	0.051
c	0.10	0.17	0.25	0.004	0.007	0.01
D	2.25	2.35	2.45	0.089	0.093	0.096
E	3.25	3.35	3.45	0.128	0.132	0.136
L	0.35	0.47	0.60	0.014	0.019	0.024
HE	3.75	3.85	3.95	0.148	0.152	0.156
θ	2°	–	8°	2°	–	8°

Packaging Options

Device	Package	Packaging Option	Quantity
SZSMF4LxxXXT1G	SOD-123FL (Pb-Free)	Tape & Reel - 12 mm tape / 7" reel	1,500
SZSMF4LxxXXT3G	SOD-123FL (Pb-Free)	Tape & Reel - 12 mm tape / 13" reel	5,000

SZSMF4L Series

Automotive, Surface Mount 400 W in SOD-123FL

Part Numbering System

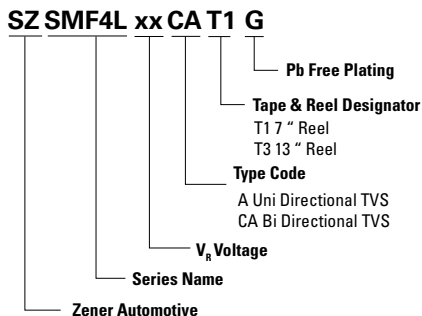

Part Marking System

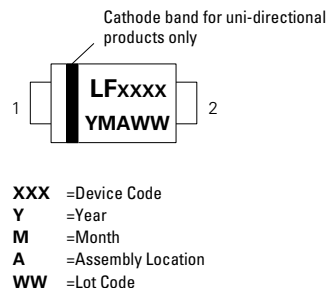

Tape and Reel Specification

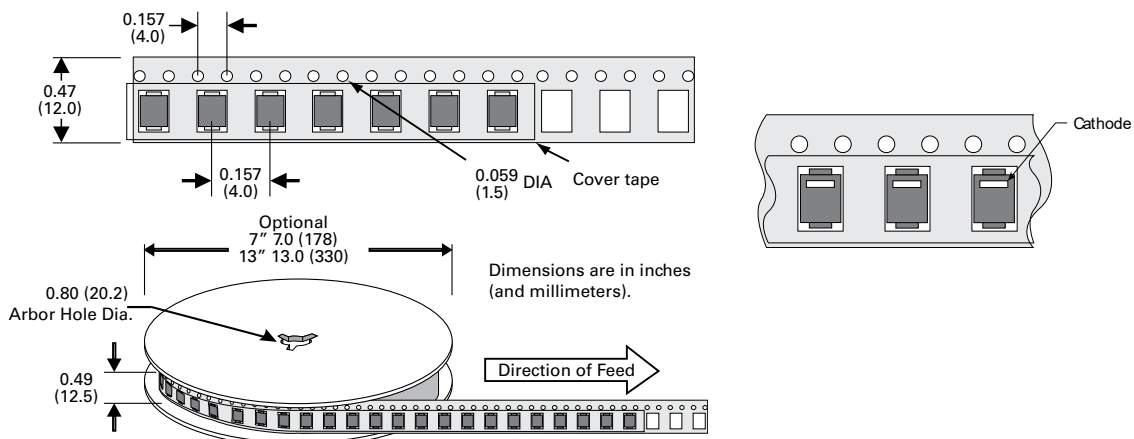

Disclaimer Notice - Information furnished is believed to be accurate and reliable. However, users should independently evaluate the suitability of and test each product selected for their own applications. Littelfuse products are not designed for, and may not be used in, all applications. Read complete Disclaimer Notice at <http://www.littelfuse.com/disclaimer-electronics>.