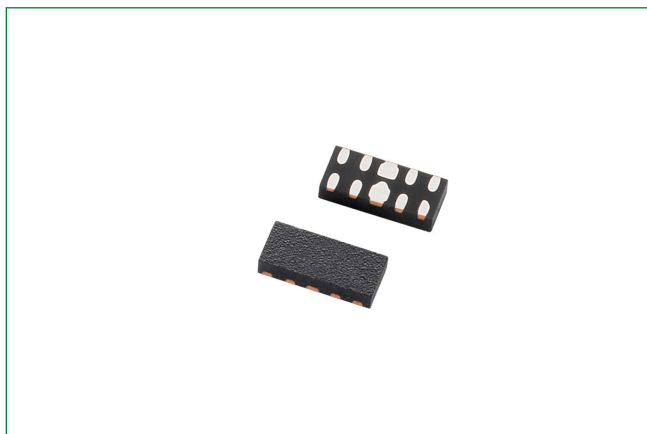

SP33R6

0.2pF, 12kV, 0.6V Breakdown Avalanche Diode for Ultra High Speed Interfaces

HF **RoHS** **Pb**

Note: This package image is for example and reference only. for detail package drawing, please refer to the package section in this datasheet.

Pinout

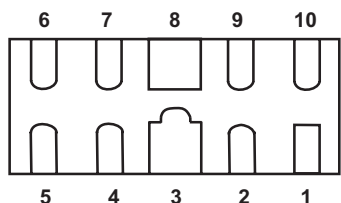

Functional Block Diagram

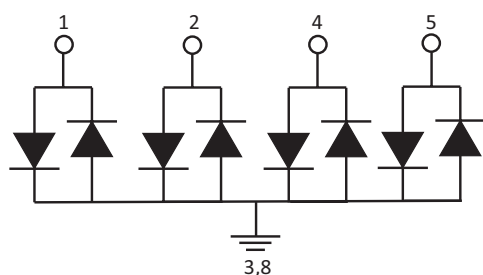

Note: pin6,7,9,10 are N.C

Description

Benchmark setting breakdown voltage performance, protecting sub 20 nm I/O's. Finer geometry chip designs run the risk of damage at voltage levels higher than 3.3V. The SP33R6 is a breakdown avalanche diode for ultra high speed interfaces and it provides headroom to support all of the low voltage differential signaling (0.3V) while protecting the data lines from damaging overvoltage, starting at 0.6V.

Features

- ESD, IEC 61000-4-2, $\pm 12\text{kV}$
- EFT, IEC 61000-4-4, 40A (5/50ns)
- Lightning, IEC 61000-4-5, 2nd Edition, 3A (8/20us)
- Low capacitance of 0.2pF (TYP) per I/O
- Halogen-free, lead-free and RoHS compliant

Applications

- USB 3.2, USB 4.0
- Thunderbolt 3.0
- PCIE

Life Support Note:

Not Intended for Use in Life Support or Life Saving Applications

The products shown herein are not designed for use in life sustaining or life saving applications unless otherwise expressly indicated.

SP33R6

0.2pF, 12kV, 0.6V Breakdown Avalanche Diode for Ultra High Speed Interfaces

Absolute Maximum Ratings

| Symbol | Parameter | Value | Units |
|------------|----------------------------------|------------|-------|
| I_{PP} | Peak Current ($t_p=8/20\mu s$) | 3 | A |
| T_{OP} | Operating Temperature | -40 to 125 | °C |
| T_{STOR} | Storage Temperature | -55 to 150 | °C |

CAUTION: Stresses above those listed in "Absolute Maximum Ratings" may cause permanent damage to the component. This is a stress only rating and operation of the component at these or any other conditions above those indicated in the operational sections of this specification is not implied.

Electrical Characteristics ($T_{OP}=25^\circ C$)

| Parameter | Symbol | Test Conditions | Min | Typ | Max | Units |
|------------------------------------|------------|-----------------------------------|----------|-----|-----|----------|
| Reverse Standoff Voltage | V_{RWM} | $I_R=1\mu A$ | | | 0.3 | V |
| Breakdown Voltage | V_{BR} | $I_R=1mA$ | 0.6 | | 0.9 | V |
| Reverse Leakage Current | I_{LEAK} | $V_R=0.3V$, Any I/O to GND | | | 100 | nA |
| Clamp Voltage ¹ | V_C | $I_{PP}=1A$, $t_p=8/20\mu s$ | | 2.5 | | V |
| | | $I_{PP}=2A$, $t_p=8/20\mu s$ | | 3.3 | | |
| Dynamic Resistance ³ | R_{DYN} | TLP, $t_p=100ns$ | | 0.3 | | Ω |
| ESD Withstand Voltage ¹ | V_{ESD} | IEC 61000-4-2 (Contact Discharge) | ± 12 | | | kV |
| | | IEC 61000-4-2 (Air Discharge) | ± 15 | | | kV |
| Line Capacitance ^{1,2} | C_L | Reverse Bias=0V, $f=3GHz$ | | 0.2 | | pF |

Note 1: Parameter is guaranteed by design and/or component characterization.

Note 2: Test equipment accuracy $\pm 50fF$.

Note 3: Transmission Line Pulse (TLP) with 100ns width, 2ns rise time, and average window $t_1=70ns$ to $t_2=90ns$

8/20 μs Pulse Waveform

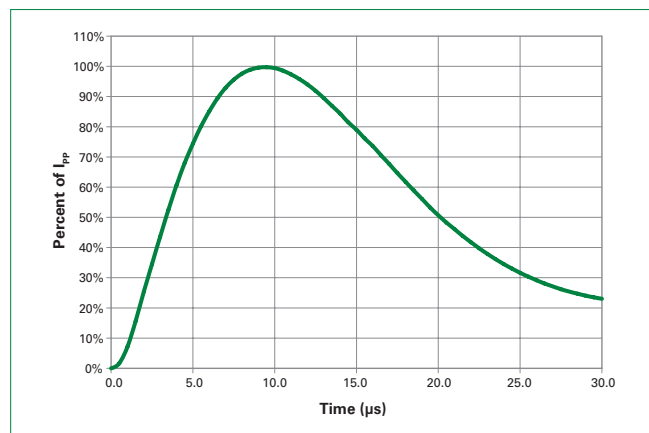

Clamping Voltage vs I_{PP}

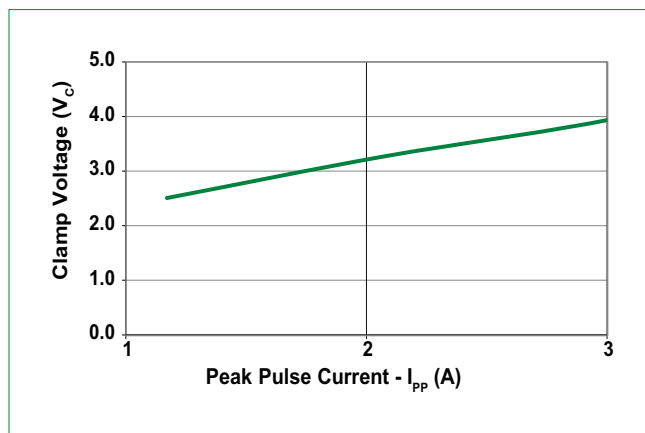

SP33R6

0.2pF, 12kV, 0.6V Breakdown Avalanche Diode for Ultra High Speed Interfaces

IEC 61000-4-2 +8 kV Contact ESD Clamping Voltage

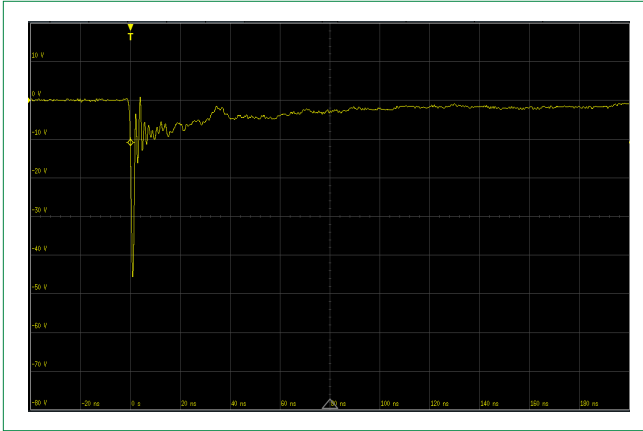

IEC 61000-4-2 -8 kV Contact ESD Clamping Voltage

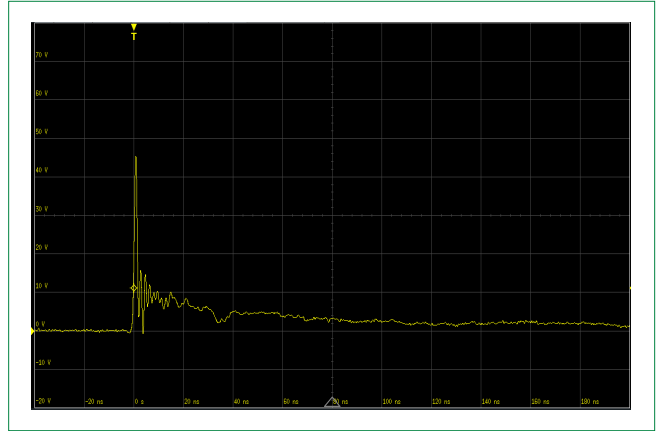

Positive Transmission Line Pulsing (TLP) Plot

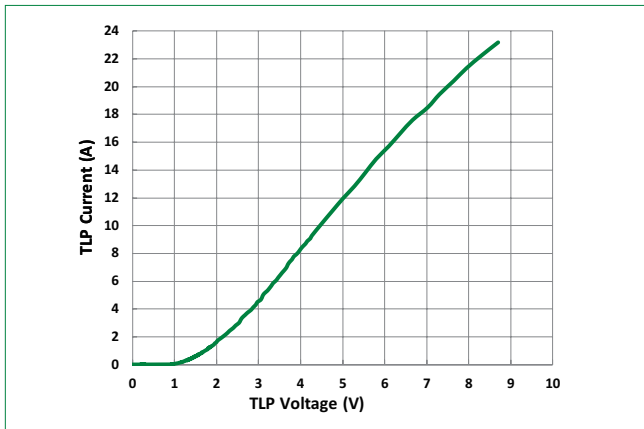

Negative Transmission Line Pulsing (TLP) Plot

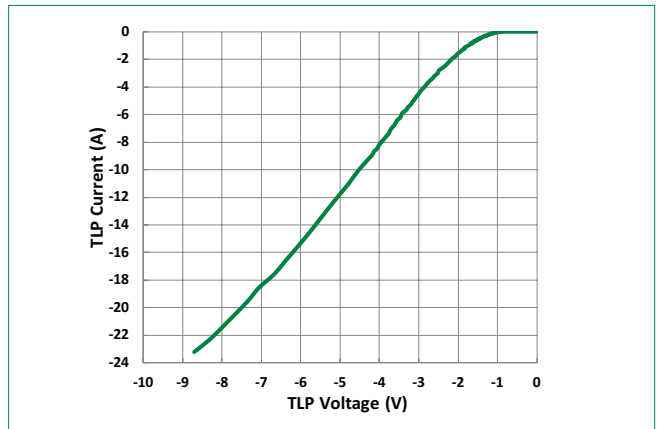

SP33R6

0.2pF, 12kV, 0.6V Breakdown Avalanche Diode for Ultra High Speed Interfaces

Soldering Parameters

| | | |
|--|------------------------------------|-------------------------|
| Reflow Condition | | Pb – Free assembly |
| Pre Heat | - Temperature Min ($T_{s(min)}$) | 150°C |
| | - Temperature Max ($T_{s(max)}$) | 200°C |
| | - Time (min to max) (t_s) | 60 – 120 secs |
| Average ramp up rate (Liquidus) Temp (T_L) to peak | | 3°C/second max |
| $T_{s(max)}$ to T_L - Ramp-up Rate | | 3°C/second max |
| Reflow | - Temperature (T_L) (Liquidus) | 217°C |
| | - Temperature (t_L) | 60 – 150 seconds |
| Peak Temperature (T_p) | | 260 ^{+0/-5} °C |
| Time within 5°C of actual peak Temperature (t_p) | | 30 seconds |
| Ramp-down Rate | | 6°C/second max |
| Time 25°C to peak Temperature (T_p) | | 8 minutes Max. |
| Do not exceed | | 260°C |

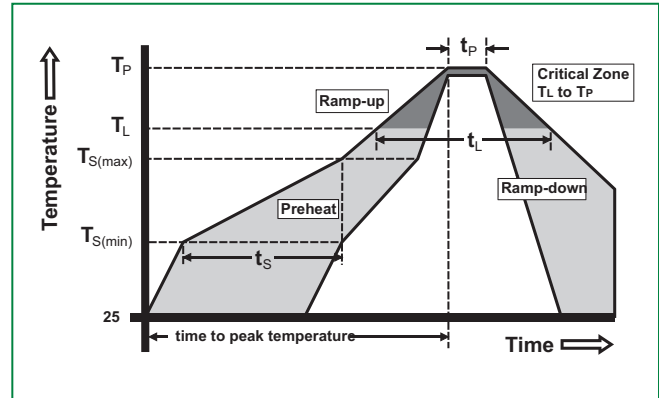

Ordering Information

| Part Number | Package | Min. Order Qty. |
|--------------|---------|-----------------|
| SP33R6-04UTG | μDFN-10 | 3000 |

Product Characteristics

| | |
|---------------------------|--|
| Lead Plating | PPF or Tin |
| Lead material | Copper Alloy |
| Substrate Material | Silicon |
| Body Material | Molded Compound |
| Flammability | UL Recognized compound meeting flammability rating V-0 |

Part Marking System

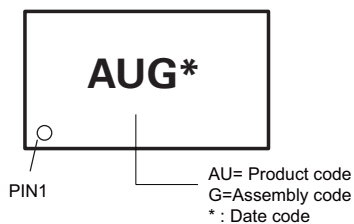

Part Numbering System

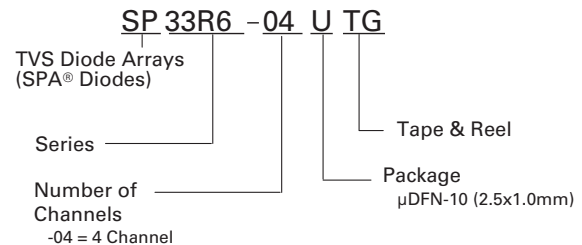

SP33R6

0.2pF, 12kV, 0.6V Breakdown Avalanche Diode for Ultra High Speed Interfaces

Package Dimensions — μ DFN-10 (2.5x1.0x0.5mm)

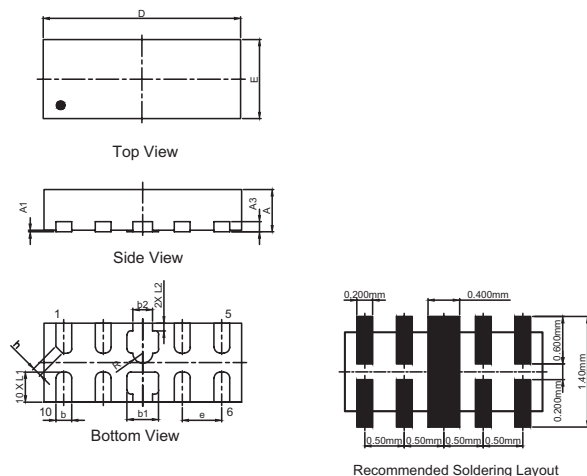

| Symbol | Millimeters | | Inches | |
|--------|-------------|-------|-------------|-------|
| | Min | Max | Min | Max |
| A | 0.50 | 0.60 | 0.020 | 0.024 |
| A1 | 0.00 | 0.05 | 0.000 | 0.002 |
| A3 | 0.125 | 0.175 | 0.005 | 0.007 |
| b | 0.15 | 0.25 | 0.006 | 0.010 |
| b1 | 0.35 | 0.45 | 0.014 | 0.018 |
| b2 | 0.20 | 0.30 | 0.008 | 0.012 |
| D | 2.45 | 2.55 | 0.096 | 0.100 |
| E | 0.95 | 1.05 | 0.037 | 0.041 |
| L1 | 0.28 | 0.48 | 0.011 | 0.019 |
| L2 | 0.05 | 0.15 | 0.002 | 0.006 |
| e | 0.500 BASIC | | 0.020 BASIC | |
| R | 0.125 REF | | 0.005 REF | |
| h | 0.08 | 0.16 | 0.003 | 0.006 |

Embossed Carrier Tape & Reel Specification — μ DFN-10

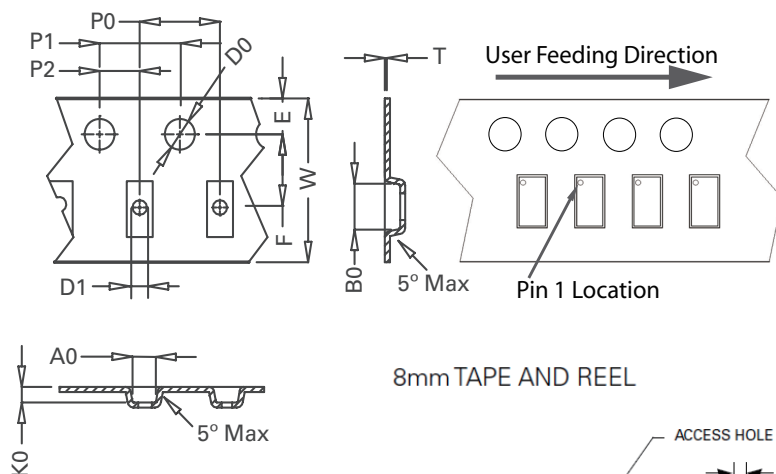

| Symbol | Millimeters |
|--------|---------------------|
| A0 | 1.30 +/- 0.10 |
| B0 | 2.83 +/- 0.10 |
| D0 | Ø 1.50 + 0.10 |
| D1 | Ø 1.00 + 0.25 |
| E | 1.75 +/- 0.10 |
| F | 3.50 +/- 0.05 |
| K0 | 0.65 +/- 0.10 |
| P0 | 4.00 +/- 0.10 |
| P1 | 4.00 +/- 0.10 |
| P2 | 2.00 +/- 0.05 |
| T | 0.254 +/- 0.02 |
| W | 8.00 + 0.30 /- 0.10 |

Product Disclaimer: Littelfuse products are not designed for, and shall not be used for, any purpose (including, without limitation, automotive, military, aerospace, medical, life-saving, life-sustaining or nuclear facility applications, devices intended for surgical implant into the body, or any other application in which the failure or lack of desired operation of the product may result in personal injury, death, or property damage) other than those expressly set forth in applicable Littelfuse product documentation. Warranties granted by Littelfuse shall be deemed void for products used for any purpose not expressly set forth in applicable Littelfuse documentation. Littelfuse shall not be liable for any claims or damages arising out of products used in applications not expressly intended by Littelfuse as set forth in applicable Littelfuse documentation. The sale and use of Littelfuse products is subject to Littelfuse Terms and Conditions of Sale, unless otherwise agreed by Littelfuse. "Littelfuse" includes Littelfuse, Inc., and all of its affiliate entities. <http://www.littelfuse.com/disclaimer-electronics>.