

# High Voltage, High Gain BIMOSFET™ Monolithic Bipolar MOS Transistor

## IXBT16N360HV IXBH16N360HV



$$V_{CES} = 3600V$$

$$I_{C110} = 16A$$

$$V_{CE(sat)} \leq 3.0V$$

Symbol	Test Conditions	Maximum Ratings	
$V_{CES}$	$T_J = 25^\circ C$ to $150^\circ C$	3600	V
$V_{CGR}$	$T_J = 25^\circ C$ to $150^\circ C$ , $R_{GE} = 1M\Omega$	3600	V
$V_{GES}$	Continuous	$\pm 20$	V
$V_{GEM}$	Transient	$\pm 30$	V
$I_{C25}$	$T_C = 25^\circ C$	48	A
$I_{C110}$	$T_C = 110^\circ C$	16	A
$I_{CM}$	$T_C = 25^\circ C$ , 1ms	72	A
<b>SSOA</b> <b>(RBSOA)</b>	$V_{GE} = 15V$ , $T_{VJ} = 125^\circ C$ , $R_G = 25\Omega$ Clamped Inductive Load	$I_{CM} = 60$ $V_{CES} \leq 1500$	A V
<b><math>T_{SC}</math></b> <b>(SCSOA)</b>	$V_{GE} = 15V$ , $T_J = 125^\circ C$ , $R_G = 82\Omega$ , $V_{CE} = 1500V$ , Non-Repetitive	10	$\mu s$
$P_C$	$T_C = 25^\circ C$	270	W
$T_J$		-55 ... +150	$^\circ C$
$T_{JM}$		150	$^\circ C$
$T_{stg}$		-55 ... +150	$^\circ C$
$T_L$	Maximum Lead Temperature for Soldering	300	$^\circ C$
$T_{SOLD}$	Plastic Body for 10s	260	$^\circ C$
$M_d$	Mounting Torque (TO-247HV)	1.13/10	Nm/lb.in
<b>Weight</b>	TO-268HV	4	g
	TO-247HV	6	g

TO-268HV (IXBT)

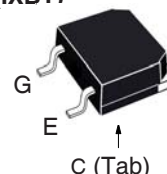

TO-247HV (IXBH)

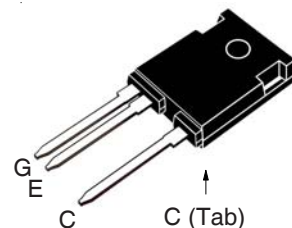

G = Gate      C = Collector  
E = Emitter    Tab = Collector

### Features

- High Voltage Packages
- High Blocking Voltage
- High Peak Current Capability
- Low Saturation Voltage

### Advantages

- Low Gate Drive Requirement
- High Power Density

### Applications

- Switch-Mode and Resonant-Mode Power Supplies
- Uninterruptible Power Supplies (UPS)
- Laser Generators
- Capacitor Discharge Circuits
- AC Switches

Symbol	Test Conditions ( $T_J = 25^\circ C$ Unless Otherwise Specified)	Characteristic Values		
		Min.	Typ.	Max.
$BV_{CES}$	$I_C = 250\mu A$ , $V_{GE} = 0V$	3600		V
$V_{GE(th)}$	$I_C = 250\mu A$ , $V_{CE} = V_{GE}$	3.0		5.0 V
$I_{CES}$	$V_{CE} = V_{CES}$ , $V_{GE} = 0V$ $T_J = 125^\circ C$			10 $\mu A$ 500 $\mu A$
$I_{GES}$	$V_{CE} = 0V$ , $V_{GE} = \pm 20V$			$\pm 100$ nA
$V_{CE(sat)}$	$I_C = 16A$ , $V_{GE} = 15V$ , Note 1 $T_J = 125^\circ C$		2.5 3.1	3.0 V V

### Symbol Test Conditions

( $T_J = 25^\circ\text{C}$  Unless Otherwise Specified)

### Characteristic Values

	Test Conditions	Characteristic Values		
		Min.	Typ.	Max.
$g_{fs}$	$I_C = 16A, V_{CE} = 10V$ , Note 1	7	12	S
$C_{ies}$	$V_{CE} = 25V, V_{GE} = 0V, f = 1MHz$		1116	pF
$C_{oes}$				
$C_{res}$				
$Q_{g(on)}$	$I_C = 16A, V_{GE} = 15V, V_{CE} = 1.5KV$		65	nC
$Q_{ge}$				
$Q_{gc}$				
$t_{d(on)}$	<b>Resistive load, <math>T_J = 25^\circ\text{C}</math></b> $I_C = 16A, V_{GE} = 15V$ $V_{CE} = 1.5KV, R_G = 25\Omega$		30	ns
$t_r$				
$t_{d(off)}$				
$t_f$				
$t_{d(on)}$	<b>Resistive load, <math>T_J = 125^\circ\text{C}</math></b> $I_C = 16A, V_{GE} = 15V$ $V_{CE} = 1.5KV, R_G = 25\Omega$		36	ns
$t_r$				
$t_{d(off)}$				
$t_f$				
$R_{thJC}$	TO-247HV	0.21		0.46 $^\circ\text{C/W}$
$R_{thCS}$				

### Reverse Diode

### Symbol Test Conditions

( $T_J = 25^\circ\text{C}$  Unless Otherwise Specified)

### Characteristic Values

	Test Conditions	Characteristic Values		
		Min.	Typ.	Max.
$V_F$	$I_F = 16A, V_{GE} = 0V$ , Note 1			3.5 V
$t_{rr}$	$I_F = 16A, V_{GE} = 0V, -di_F/dt = 100A/\mu s$ $V_R = 100V, V_{GE} = 0V$		620	ns
$I_{RM}$				
$Q_{RM}$				

Note: 1. Pulse test,  $t \leq 300\mu s$ , duty cycle,  $d \leq 2\%$ .

### ADVANCE TECHNICAL INFORMATION

The product presented herein is under development. The Technical Specifications offered are derived from a subjective evaluation of the design, based upon prior knowledge and experience, and constitute a "considered reflection" of the anticipated result. IXYS reserves the right to change limits, test conditions, and dimensions without notice.

IXYS Reserves the Right to Change Limits, Test Conditions and Dimensions.

IXYS MOSFETs and IGBTs are covered 4,835,592 4,931,844 5,049,961 5,237,481 6,162,665 6,404,065 B1 6,683,344 6,727,585 7,005,734 B2 7,157,338 B2  
by one or more of the following U.S. patents: 4,860,072 5,017,508 5,063,307 5,381,025 6,259,123 B1 6,534,343 6,710,405 B2 6,759,692 7,063,975 B2  
4,881,106 5,034,796 5,187,117 5,486,715 6,306,728 B1 6,583,505 6,710,463 6,771,478 B2 7,071,537

### TO-268HV Outline

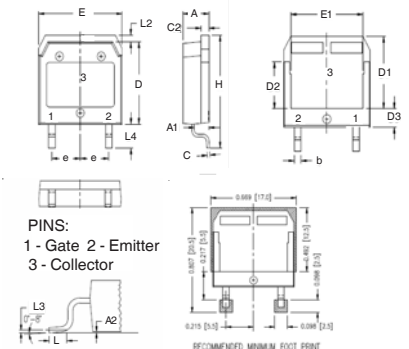

SYM	INCHES		MILLIMETER	
	MIN	MAX	MIN	MAX
A	.193	.201	4.90	5.10
A1	.106	.114	2.70	2.90
A2	.001	.010	0.02	0.25
b	.045	.057	1.15	1.45
C	.016	.026	0.40	0.65
C2	.057	.063	1.45	1.60
D	.543	.551	13.80	14.00
D1	.465	.476	11.80	12.10
D2	.295	.307	7.50	7.80
D3	.114	.126	2.90	3.20
E	.624	.632	15.85	16.05
E1	.524	.535	13.30	13.60
E2	.215	BSC	5.45	BSC
H	.736	.752	18.70	19.10
L	.067	.079	1.70	2.00
L2	.039	.045	1.00	1.15
L3	.010	BSC	0.25	BSC
L4	.150	.161	3.80	4.10

### TO-247HV Outline

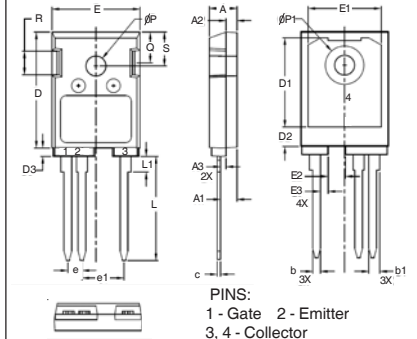

SYM	INCHES		MILLIMETERS	
	MIN	MAX	MIN	MAX
A	.193	.201	4.90	5.10
A1	.114	.122	2.90	3.10
A2	.075	.083	1.90	2.10
A3	.035	.043	0.90	1.10
b	.053	.059	1.35	1.50
b1	.075	.083	1.90	2.10
c	.022	.030	0.55	0.75
D	.819	.843	20.80	21.40
D1	.638	.646	16.20	16.40
D2	.134	.146	3.40	3.70
D3	.055	.063	1.40	1.60
E	.622	.638	15.80	16.20
E1	.520	.528	13.20	13.40
E2	.118	.126	3.00	3.20
E3	.051	.059	1.30	1.50
e	.100	BSC	2.54	BSC
e1	.300	BSC	7.62	BSC
L	.732	.748	18.60	19.00
L1	.106	.118	2.70	3.00
øP	.138	.142	3.50	3.60
øP1	.272	.280	6.90	7.10
Q	.216	.224	5.50	5.70
R	.165	.169	4.20	4.30
S	.240	.248	6.10	6.30

**Fig. 1. Output Characteristics @  $T_J = 25^\circ\text{C}$**

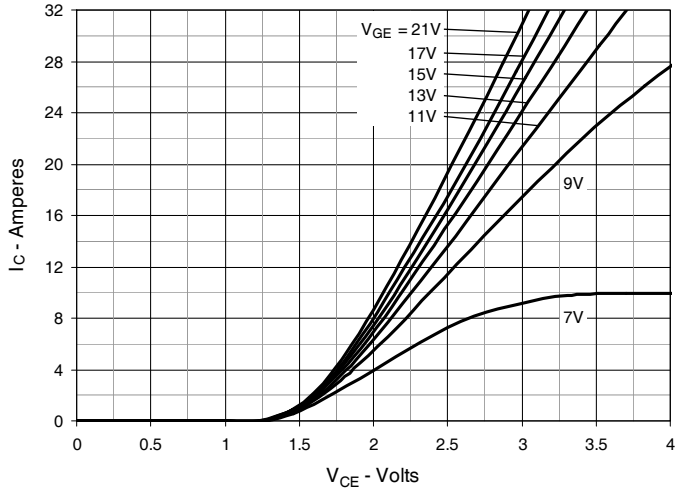

**Fig. 2. Extended Output Characteristics @  $T_J = 25^\circ\text{C}$**

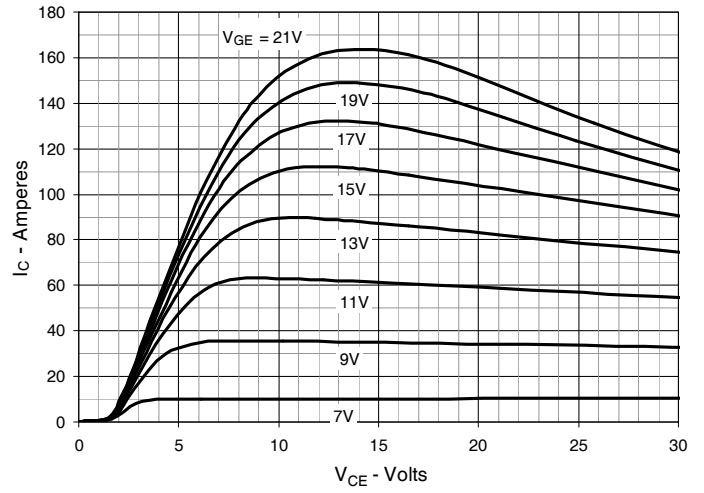

**Fig. 3. Output Characteristics @  $T_J = 125^\circ\text{C}$**

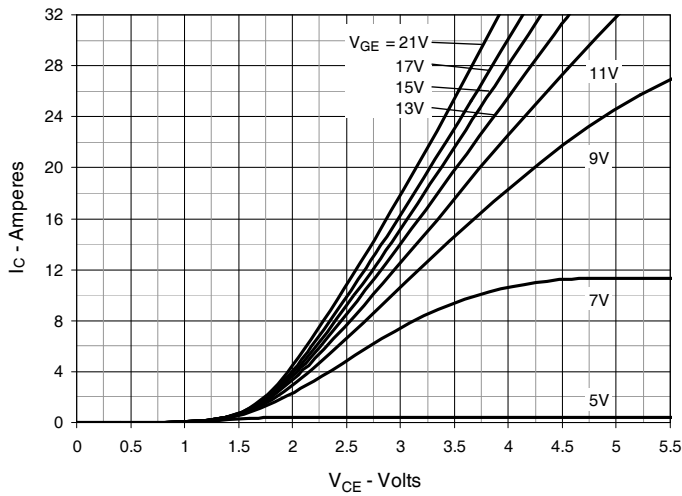

**Fig. 4. Dependence of  $V_{CE(sat)}$  on Junction Temperature**

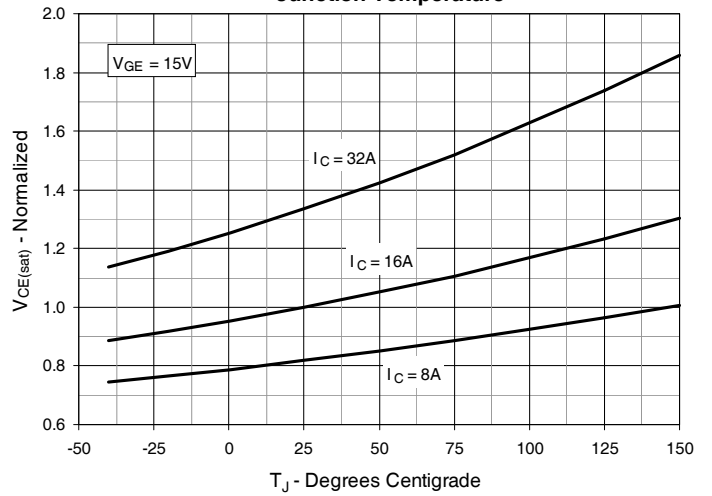

**Fig. 5. Collector-to-Emitter Voltage vs. Gate-to-Emitter Voltage**

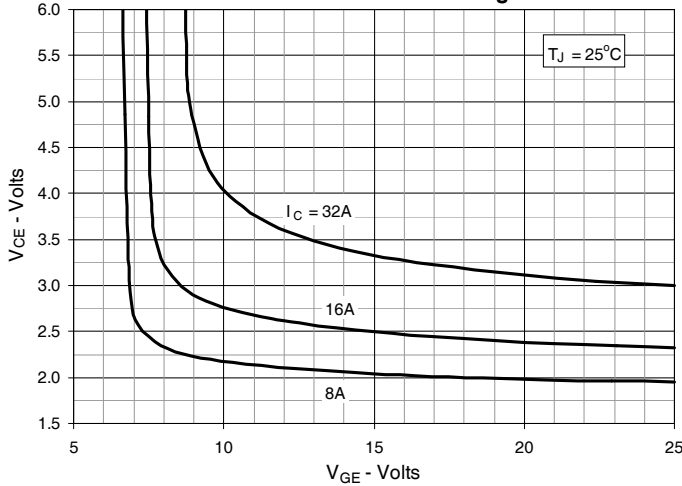

**Fig. 6. Input Admittance**

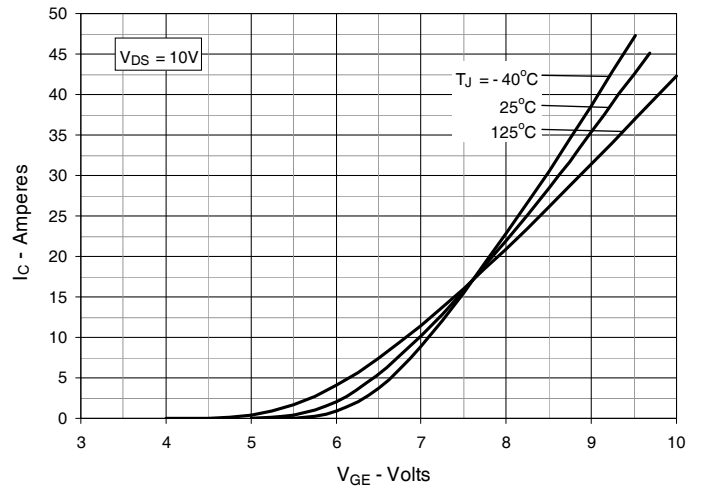

Fig. 7. Transconductance

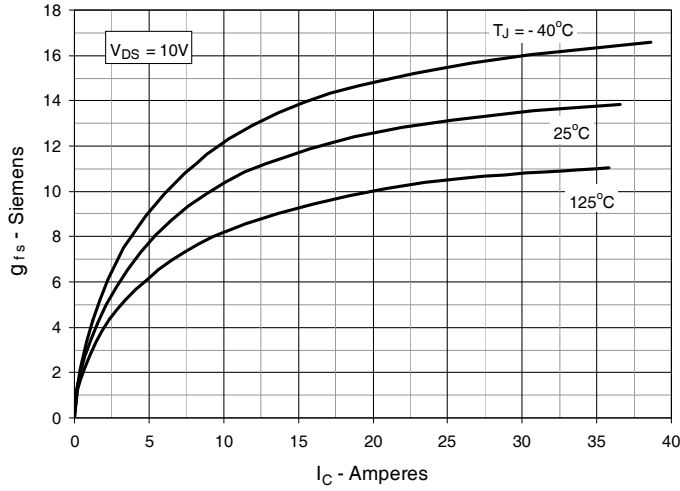

Fig. 8. Forward Voltage Drop of Intrinsic Diode

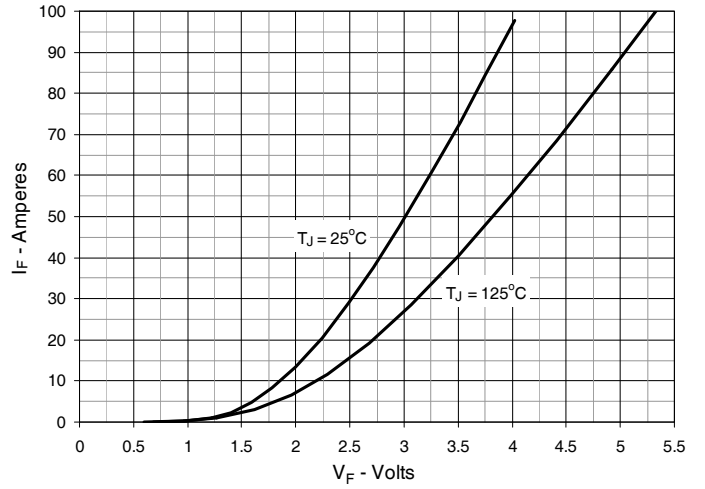

Fig. 9. Gate Charge

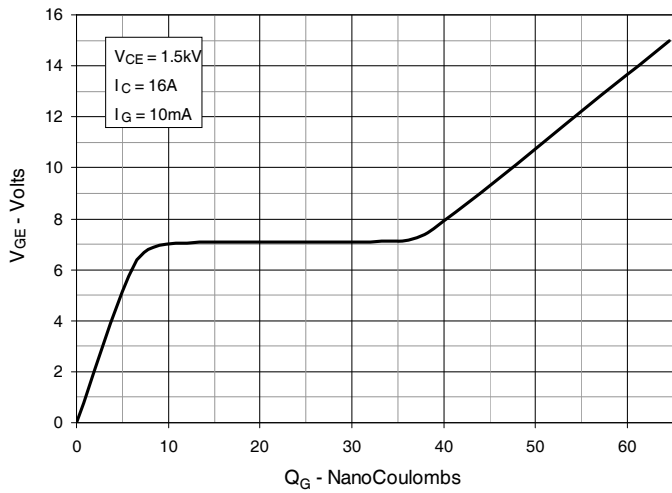

Fig. 10. Capacitance

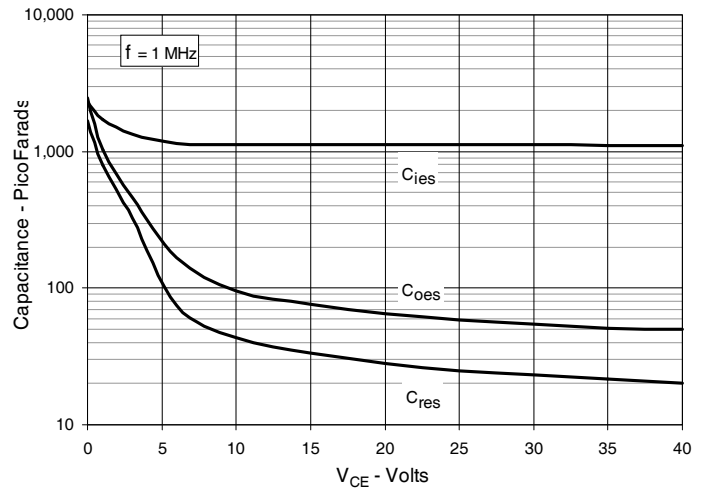

Fig. 11. Reverse-Bias Safe Operating Area

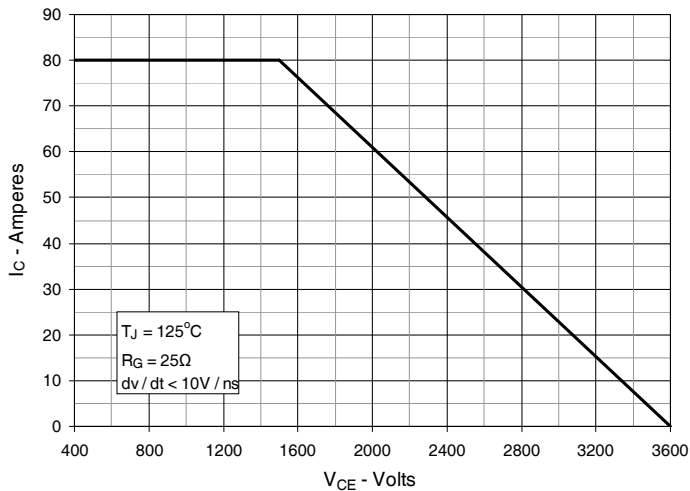
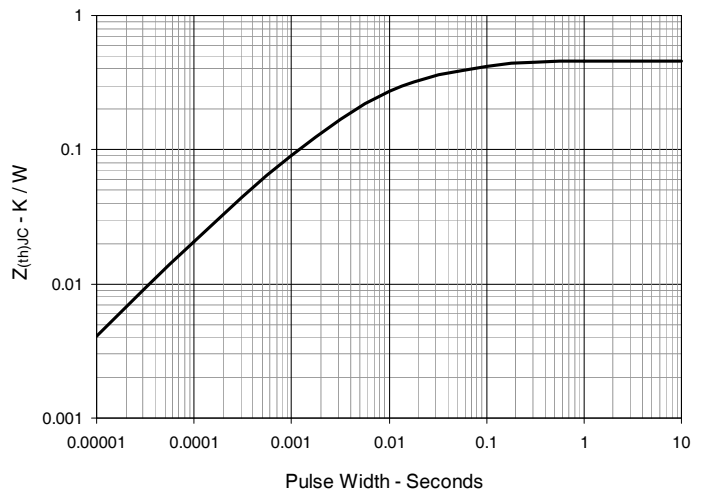
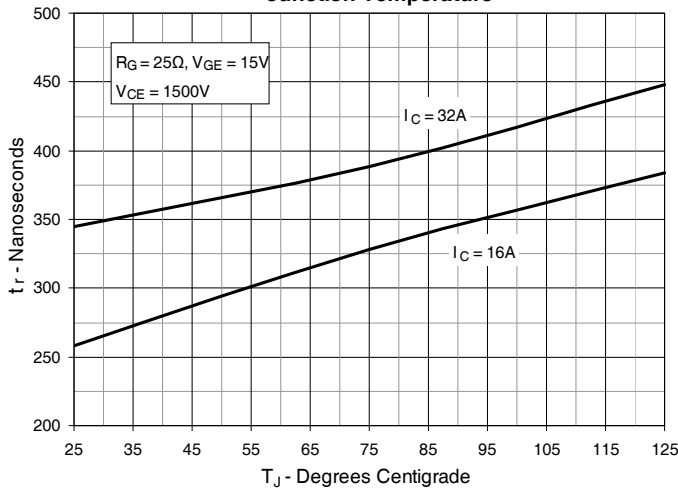

Fig. 12. Maximum Transient Thermal Impedance



**Fig. 13. Resistive Turn-on Rise Time vs. Junction Temperature**



**Fig. 14. Resistive Turn-on Rise Time vs. Collector Current**

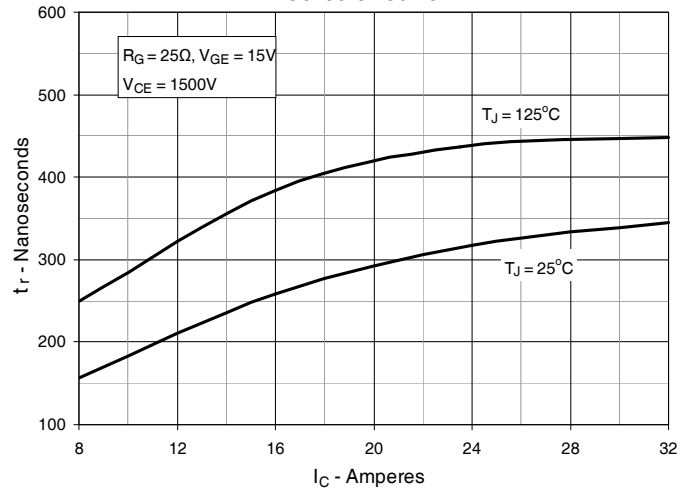

**Fig. 15. Resistive Turn-on Switching Times vs. Gate Resistance**

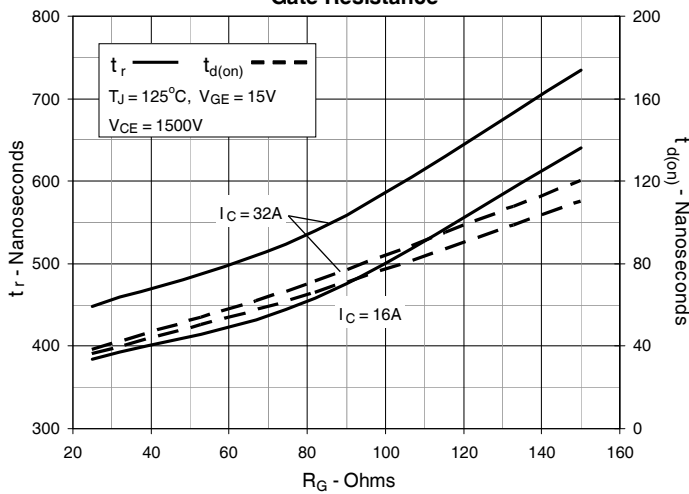

**Fig. 16. Resistive Turn-off Switching Times vs. Junction Temperature**

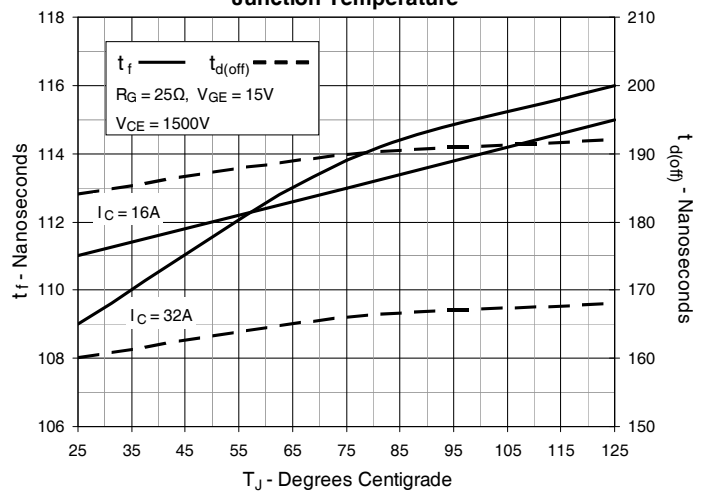

**Fig. 17. Resistive Turn-off Switching Times vs. Collector Current**

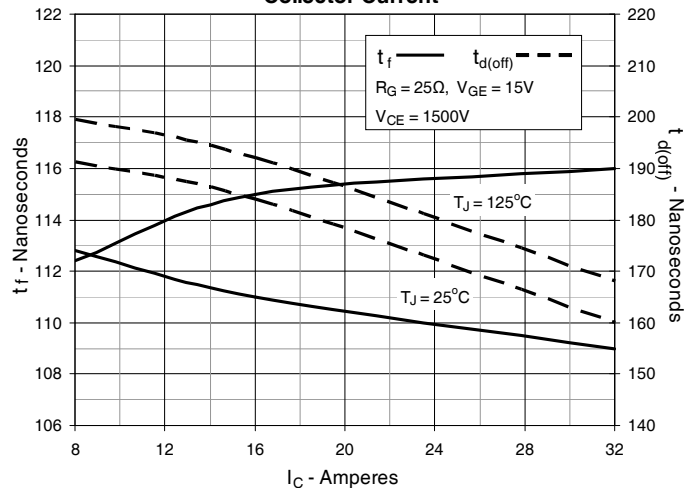

**Fig. 18. Resistive Turn-off Switching Times vs. Gate Resistance**

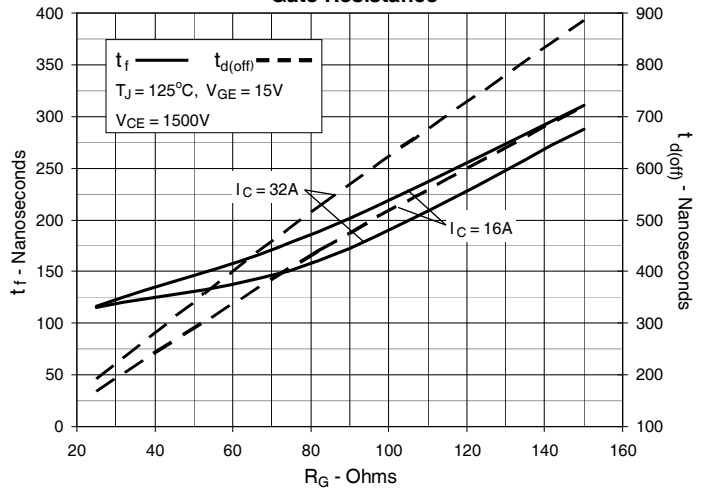

Fig. 19. Forward-Bias Safe Operating Area @  $T_C = 25^\circ\text{C}$

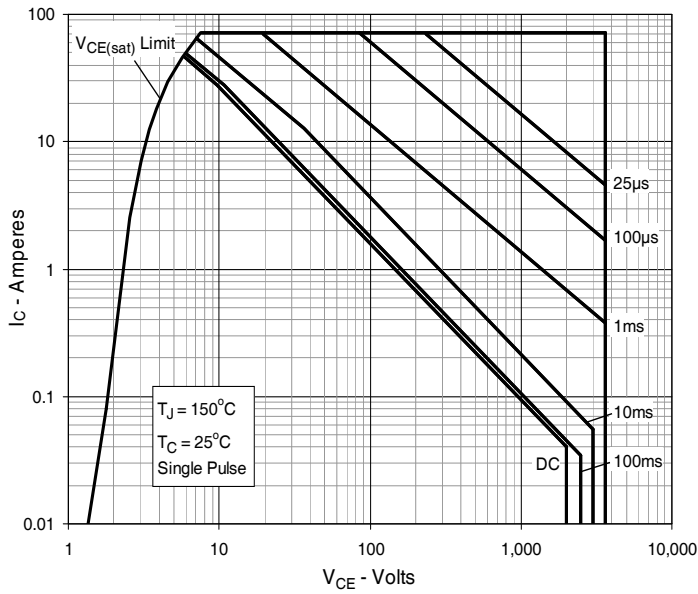
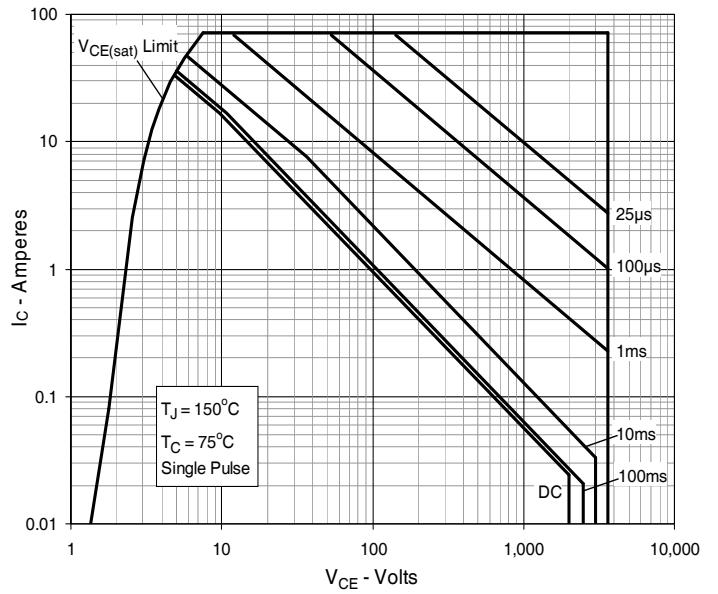

Fig. 20. Forward-Bias Safe Operating Area @  $T_C = 75^\circ\text{C}$





---

Disclaimer Notice - Information furnished is believed to be accurate and reliable. However, users should independently evaluate the suitability of and test each product selected for their own applications. Littelfuse products are not designed for, and may not be used in, all applications. Read complete Disclaimer Notice at [www.littelfuse.com/disclaimer-electronics](http://www.littelfuse.com/disclaimer-electronics).