

High Voltage XPT™ IGBT

IXYT25N250CHV IXYH25N250CHV

$$V_{CES} = 2500V$$

$$I_{C110} = 25A$$

$$V_{CE(sat)} \leq 4.0V$$

$$t_{fi(typ)} = 246ns$$

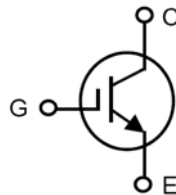

| Symbol | Test Conditions | Maximum Ratings | |
|-------------------------------|---|-----------------|------------|
| V_{CES} | $T_J = 25^\circ C$ to $175^\circ C$ | 2500 | V |
| V_{CGR} | $T_J = 25^\circ C$ to $175^\circ C$, $R_{GE} = 1M\Omega$ | 2500 | V |
| V_{GES} | Continuous | ± 20 | V |
| V_{GEM} | Transient | ± 30 | V |
| I_{C25} | $T_C = 25^\circ C$ | 95 | A |
| I_{C110} | $T_C = 110^\circ C$ | 25 | A |
| I_{CM} | $T_C = 25^\circ C$, 1ms | 235 | A |
| SSOA (RBSOA) | $V_{GE} = 15V$, $T_{VJ} = 150^\circ C$, $R_G = 5\Omega$ Clamped Inductive Load | $I_{CM} = 100$ | A |
| | | 1500 | V |
| P_C | $T_C = 25^\circ C$ | 937 | W |
| T_J | | -55 ... +175 | $^\circ C$ |
| T_{JM} | | 175 | $^\circ C$ |
| T_{stg} | | -55 ... +175 | $^\circ C$ |
| T_L | Maximum Lead Temperature for Soldering | 300 | $^\circ C$ |
| T_{SOLD} | Plastic Body for 10s | 260 | $^\circ C$ |
| M_d | Mounting Torque | 1.13/10 | Nm/lb.in |
| Weight | TO-268HV | 4 | g |
| | TO-247HV | 6 | g |

TO-268HV (IXYT)

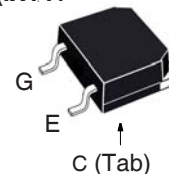

TO-247HV (IXYH)

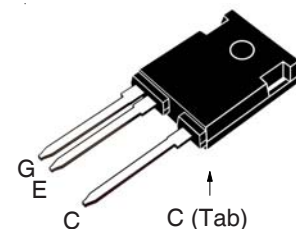

G = Gate C = Drain
E = Source Tab = Drain

Features

- High Voltage Package
- High Blocking Voltage
- High Peak Current Capability
- Low Saturation Voltage

Advantages

- Low Gate Drive Requirement
- High Power Density

Applications

- Switch-Mode and Resonant-Mode Power Supplies
- Uninterruptible Power Supplies (UPS)
- Laser Generators
- Capacitor Discharge Circuits
- AC Switches

| Symbol | Test Conditions ($T_J = 25^\circ C$, Unless Otherwise Specified) | Characteristic Values | | |
|---------------|---|-----------------------|------|--------------|
| | | Min. | Typ. | Max. |
| BV_{CES} | $I_C = 250\mu A$, $V_{GE} = 0V$ | 2500 | | V |
| $V_{GE(th)}$ | $I_C = 250\mu A$, $V_{CE} = V_{GE}$ | 3.0 | | 5.0 V |
| I_{CES} | $V_{CE} = V_{CES}$, $V_{GE} = 0V$ $T_J = 100^\circ C$ | | | 25 μA |
| | | | 100 | μA |
| I_{GES} | $V_{CE} = 0V$, $V_{GE} = \pm 20V$ | | | ± 100 nA |
| $V_{CE(sat)}$ | $I_C = 25A$, $V_{GE} = 15V$, Note 1 $T_J = 150^\circ C$ | | 3.4 | 4.0 V |
| | | | 4.7 | V |

Symbol Test Conditions

($T_J = 25^\circ\text{C}$ Unless Otherwise Specified)

Characteristic Values

| | | Min. | Typ. | Max. | |
|--------------|---|------|------|-------------------------|----------|
| g_{fs} | $I_C = 25\text{A}, V_{CE} = 10\text{V}$, Note 1 | 16 | 27 | | S |
| R_{Gi} | Gate Input Resistance | | 2.8 | | Ω |
| C_{ies} | $V_{CE} = 25\text{V}, V_{GE} = 0\text{V}, f = 1\text{MHz}$ | | 3060 | | pF |
| C_{oes} | | | 114 | | pF |
| C_{res} | | | 43 | | pF |
| $Q_{g(on)}$ | $I_C = 25\text{A}, V_{GE} = 15\text{V}, V_{CE} = 0.5 \cdot V_{CES}$ | | 147 | | nC |
| Q_{ge} | | | 16 | | nC |
| Q_{gc} | | | 68 | | nC |
| $t_{d(on)}$ | Inductive load, $T_J = 25^\circ\text{C}$ $I_C = 25\text{A}, V_{GE} = 15\text{V}$ $V_{CE} = 0.5 \cdot V_{CES}, R_G = 5\Omega$ Note 2 | | 15 | | ns |
| t_{ri} | | | 34 | | ns |
| E_{on} | | | 8.3 | | mJ |
| $t_{d(off)}$ | | | 230 | | ns |
| t_{fi} | | | 246 | | ns |
| E_{off} | | 7.3 | | mJ | |
| $t_{d(on)}$ | Inductive load, $T_J = 150^\circ\text{C}$ $I_C = 25\text{A}, V_{GE} = 15\text{V}$ $V_{CE} = 0.5 \cdot V_{CES}, R_G = 5\Omega$ Note 2 | | 18 | | ns |
| t_{ri} | | | 33 | | ns |
| E_{on} | | | 11.0 | | mJ |
| $t_{d(off)}$ | | | 225 | | ns |
| t_{fi} | | | 350 | | ns |
| E_{off} | | 10.5 | | mJ | |
| R_{thJC} | | | | 0.16 $^\circ\text{C/W}$ | |
| R_{thCS} | | 0.15 | | $^\circ\text{C/W}$ | |

TO-268HV Outline

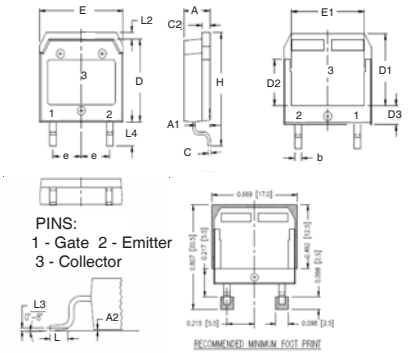

| SYM | INCHES | | MILLIMETER | |
|-----------|--------|------|------------|-------|
| | MIN | MAX | MIN | MAX |
| A | .193 | .201 | 4.90 | 5.10 |
| A1 | .106 | .114 | 2.70 | 2.90 |
| A2 | .001 | .010 | 0.02 | 0.25 |
| b | .045 | .057 | 1.15 | 1.45 |
| C | .016 | .026 | 0.40 | 0.65 |
| C2 | .057 | .063 | 1.45 | 1.60 |
| D | .543 | .551 | 13.80 | 14.00 |
| D1 | .465 | .476 | 11.80 | 12.10 |
| D2 | .295 | .307 | 7.50 | 7.80 |
| D3 | .114 | .126 | 2.90 | 3.20 |
| E | .624 | .632 | 15.85 | 16.05 |
| E1 | .524 | .535 | 13.30 | 13.60 |
| \square | .215 | BSC | 5.45 | BSC |
| H | .736 | .752 | 18.70 | 19.10 |
| L | .067 | .079 | 1.70 | 2.00 |
| L2 | .039 | .045 | 1.00 | 1.15 |
| L3 | .010 | BSC | 0.25 | BSC |
| L4 | .150 | .161 | 3.80 | 4.10 |

TO-247HV Outline

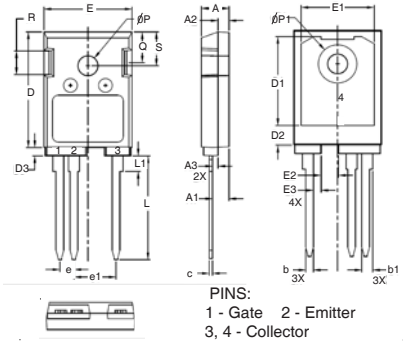

| SYM | INCHES | | MILLIMETERS | |
|-----------|--------|------|-------------|-------|
| | MIN | MAX | MIN | MAX |
| A | .193 | .201 | 4.90 | 5.10 |
| A1 | .114 | .122 | 2.90 | 3.10 |
| A2 | .075 | .083 | 1.90 | 2.10 |
| A3 | .035 | .043 | 0.90 | 1.10 |
| b | .053 | .059 | 1.35 | 1.50 |
| b1 | .075 | .083 | 1.90 | 2.10 |
| c | .022 | .030 | 0.55 | 0.75 |
| D | .819 | .843 | 20.80 | 21.40 |
| D1 | .638 | .646 | 16.20 | 16.40 |
| D2 | .134 | .146 | 3.40 | 3.70 |
| D3 | .055 | .063 | 1.40 | 1.60 |
| E | .622 | .638 | 15.80 | 16.20 |
| E1 | .520 | .528 | 13.20 | 13.40 |
| E2 | .118 | .126 | 3.00 | 3.20 |
| E3 | .051 | .059 | 1.30 | 1.50 |
| e | .100 | BSC | 2.54 | BSC |
| e1 | .300 | BSC | 7.62 | BSC |
| L | .732 | .748 | 18.60 | 19.00 |
| L1 | .106 | .118 | 2.70 | 3.00 |
| ϕP | .138 | .142 | 3.50 | 3.60 |
| $\phi P1$ | .272 | .280 | 6.90 | 7.10 |
| Q | .216 | .224 | 5.50 | 5.70 |
| R | .165 | .169 | 4.20 | 4.30 |
| S | .240 | .248 | 6.10 | 6.30 |

Note: 1. Pulse test, $t \leq 300\mu\text{s}$, duty cycle, $d \leq 2\%$.

ADVANCE TECHNICAL INFORMATION

The product presented herein is under development. The Technical Specifications offered are derived from a subjective evaluation of the design, based upon prior knowledge and experience, and constitute a "considered reflection" of the anticipated result. IXYS reserves the right to change limits, test conditions, and dimensions without notice.

IXYS Reserves the Right to Change Limits, Test Conditions, and Dimensions.

IXYS MOSFETs and IGBTs are covered by one or more of the following U.S. patents:

| | | | | | | | | | |
|-----------|-----------|-----------|-----------|--------------|--------------|--------------|--------------|--------------|--------------|
| 4,835,592 | 4,931,844 | 5,049,961 | 5,237,481 | 6,162,665 | 6,404,065 B1 | 6,683,344 | 6,727,585 | 7,005,734 B2 | 7,157,338 B2 |
| 4,860,072 | 5,017,508 | 5,063,307 | 5,381,025 | 6,259,123 B1 | 6,534,343 | 6,710,405 B2 | 6,759,692 | 7,063,975 B2 | |
| 4,881,106 | 5,034,796 | 5,187,117 | 5,486,715 | 6,306,728 B1 | 6,583,505 | 6,710,463 | 6,771,478 B2 | 7,071,537 | |

Fig. 1. Output Characteristics @ $T_J = 25^\circ\text{C}$

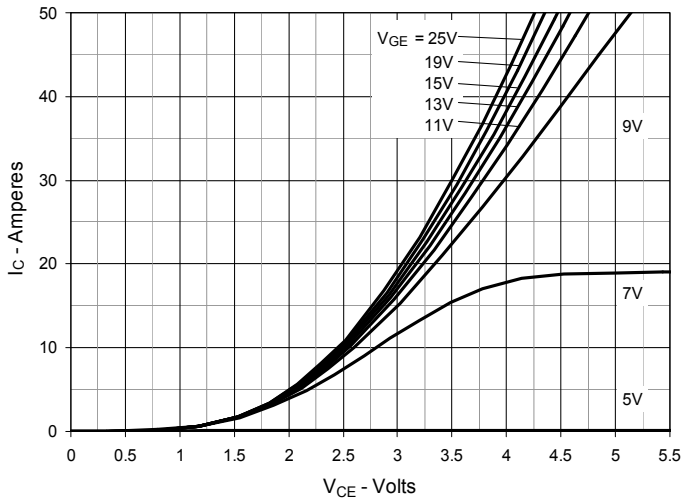

Fig. 2. Extended Output Characteristics @ $T_J = 25^\circ\text{C}$

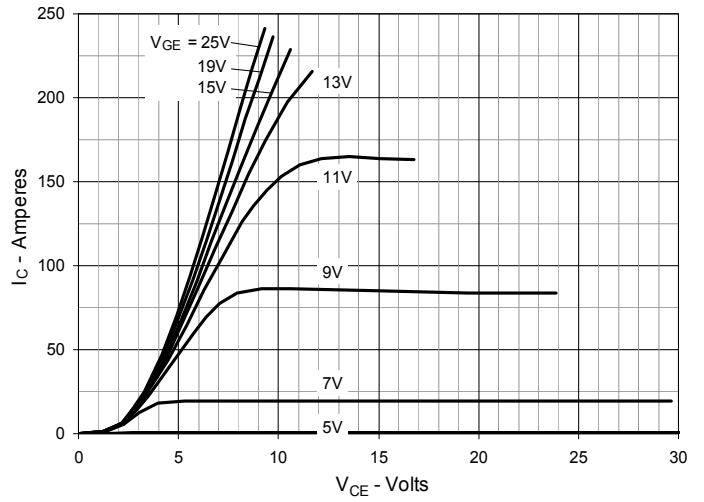

Fig. 3. Output Characteristics @ $T_J = 150^\circ\text{C}$

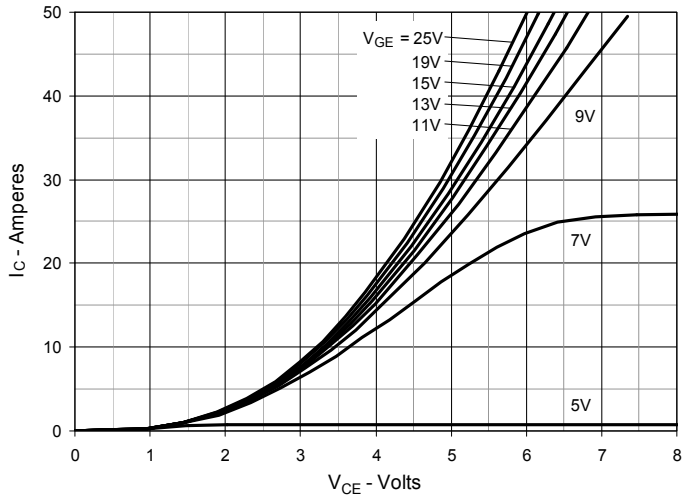

Fig. 4. Dependence of $V_{CE(sat)}$ on Junction Temperature

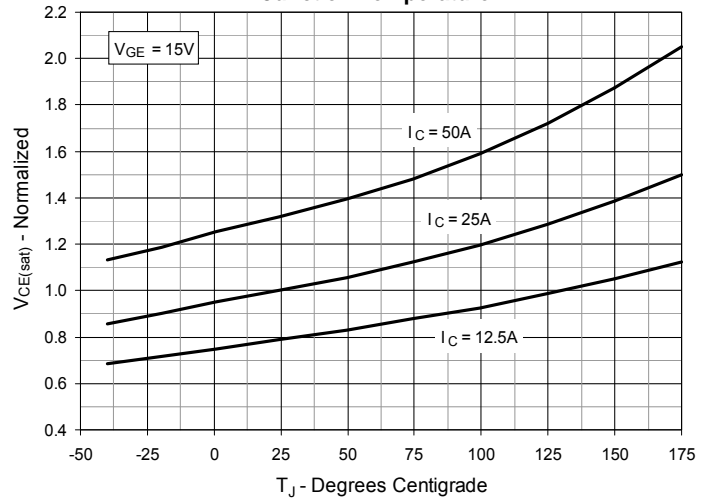

Fig. 5. Collector-to-Emitter Voltage vs. Gate-to-Emitter Voltage

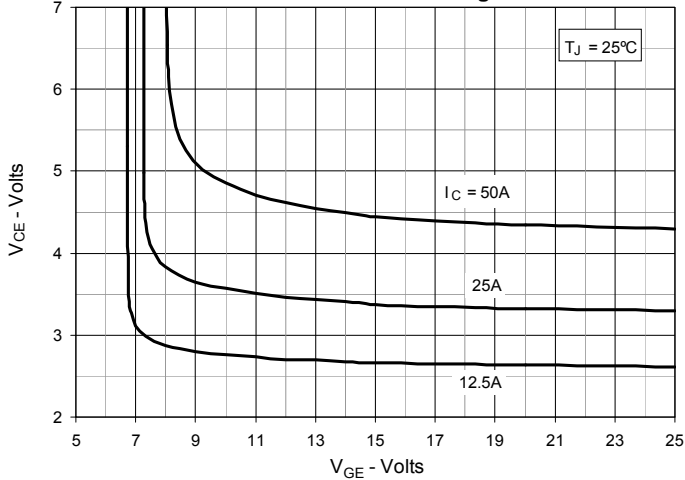

Fig. 6. Input Admittance

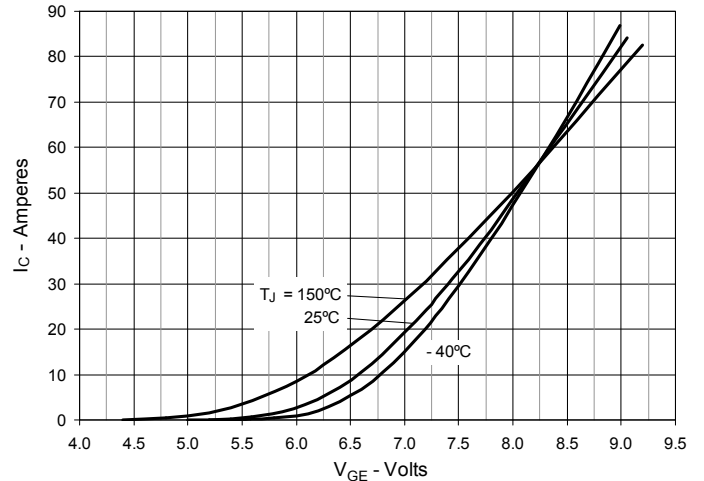

Fig. 7. Transconductance

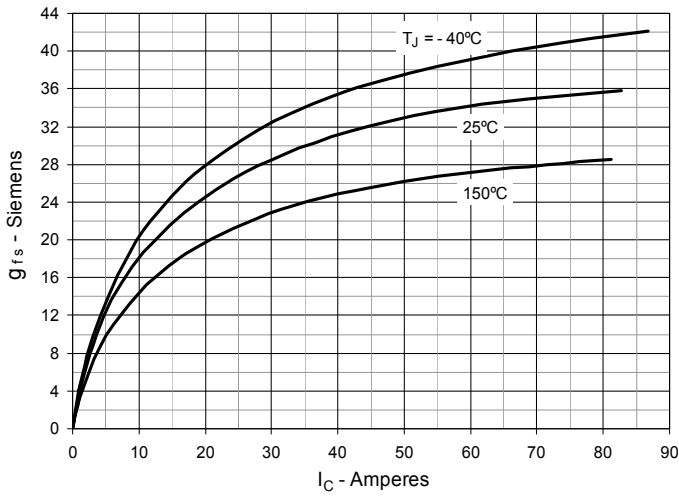

Fig. 8. Gate Charge

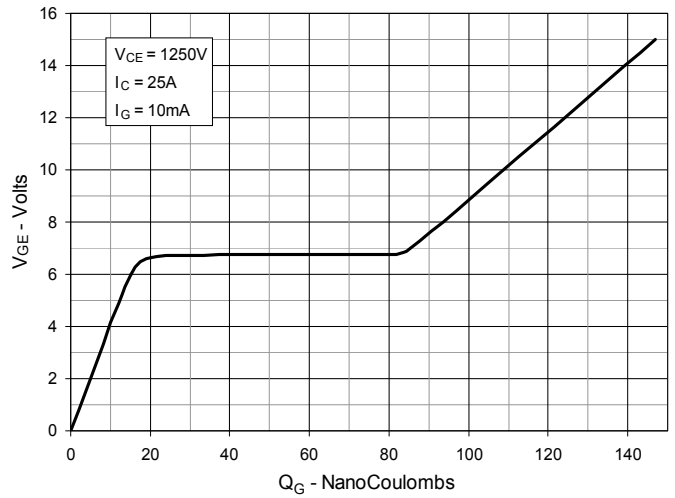

Fig. 9. Capacitance

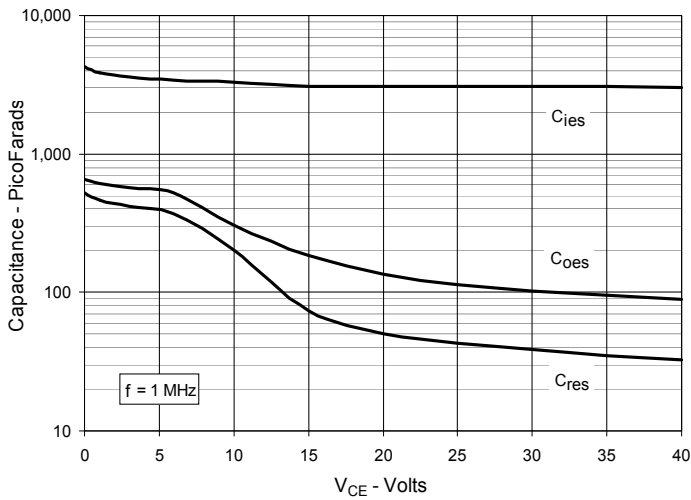

Fig. 10. Reverse-Bias Safe Operating Area

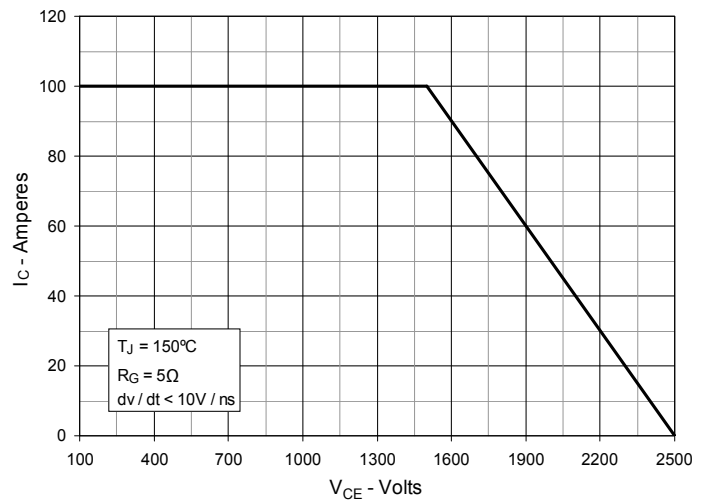

Fig. 11. Forward-Bias Safe Operating Area

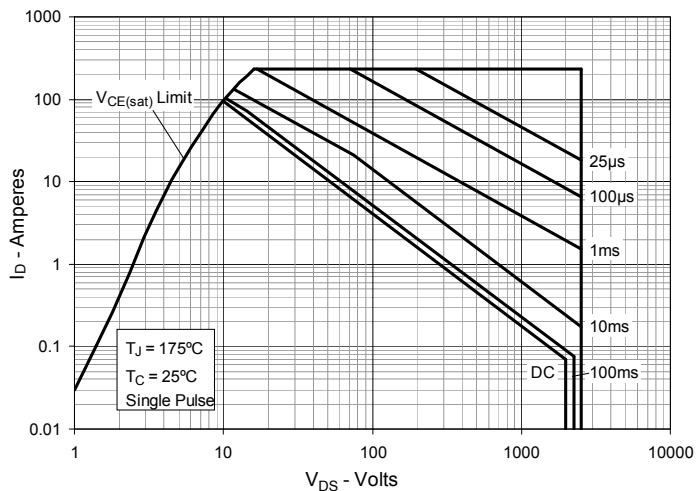

Fig. 12. Maximum Transient Thermal Impedance

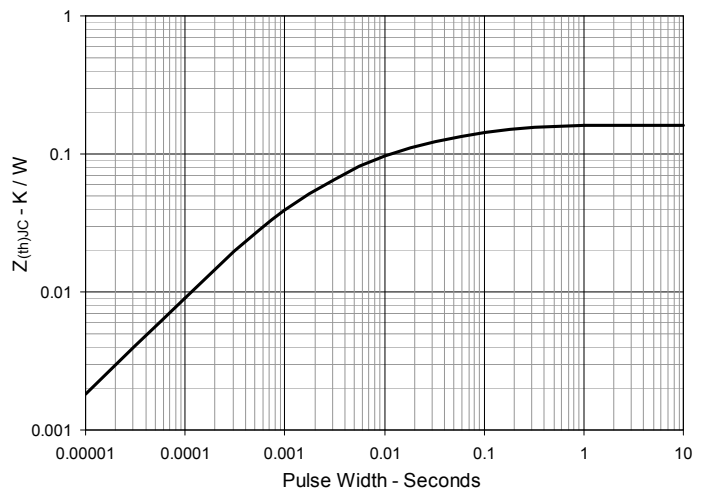

Fig. 13. Inductive Switching Energy Loss vs. Gate Resistance

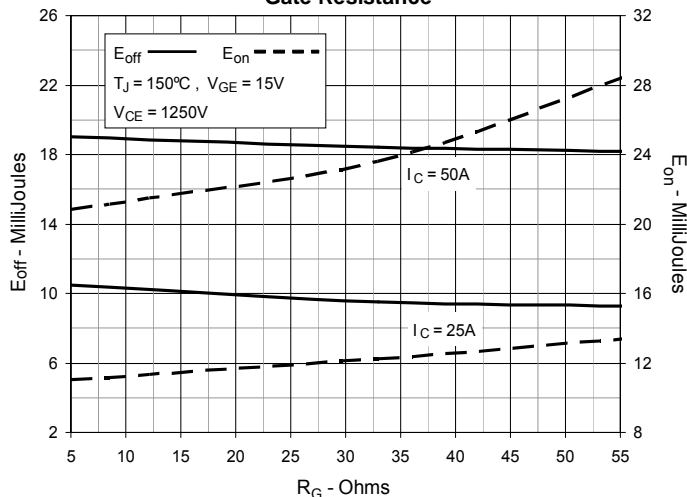

Fig. 14. Inductive Switching Energy Loss vs. Collector Current

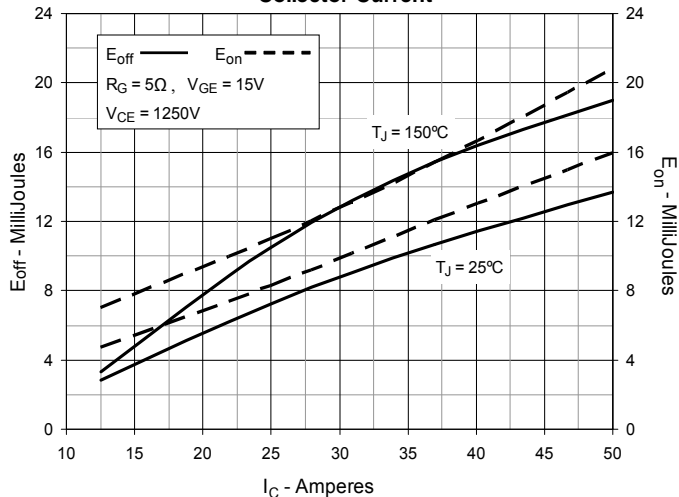

Fig. 15. Inductive Switching Energy Loss vs. Junction Temperature

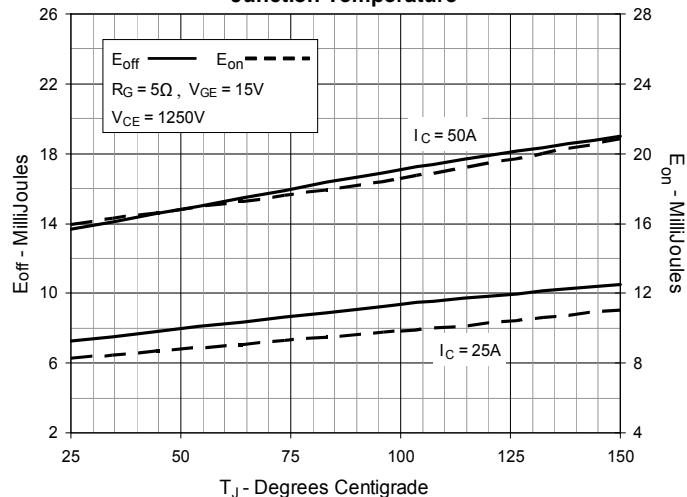

Fig. 16. Inductive Turn-off Switching Times vs. Gate Resistance

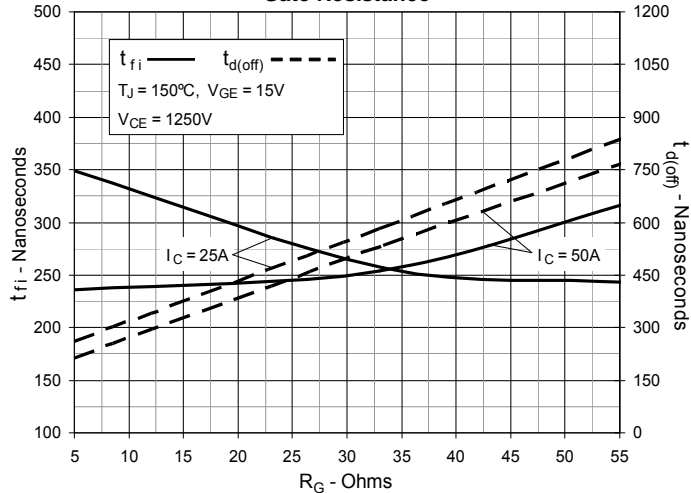

Fig. 17. Inductive Turn-off Switching Times vs. Collector Current

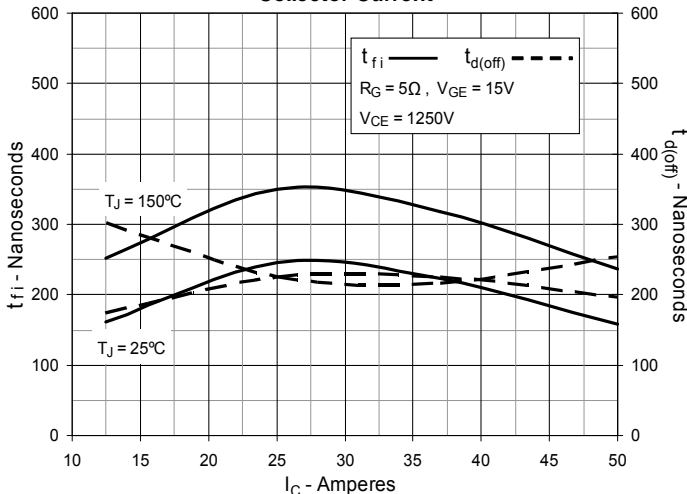

Fig. 18. Inductive Turn-off Switching Times vs. Junction Temperature

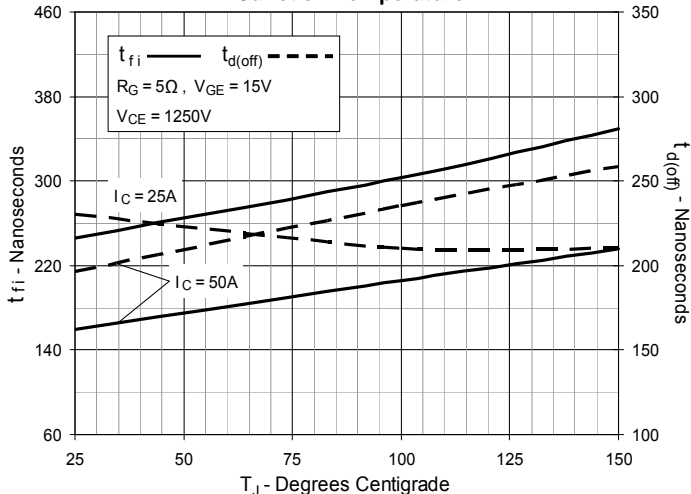

Fig. 19. Inductive Turn-on Switching Times vs. Gate Resistance

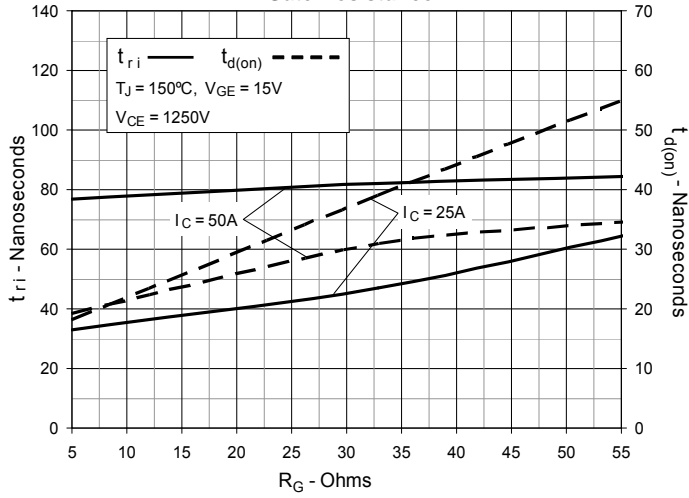

Fig. 20. Inductive Turn-on Switching Times vs. Collector Current

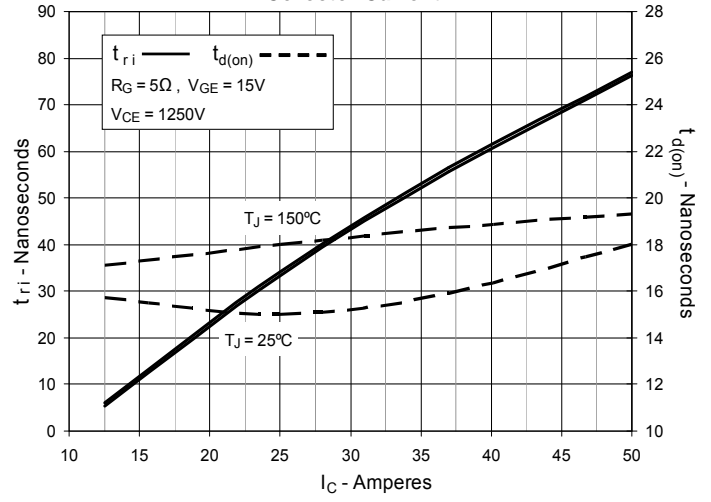
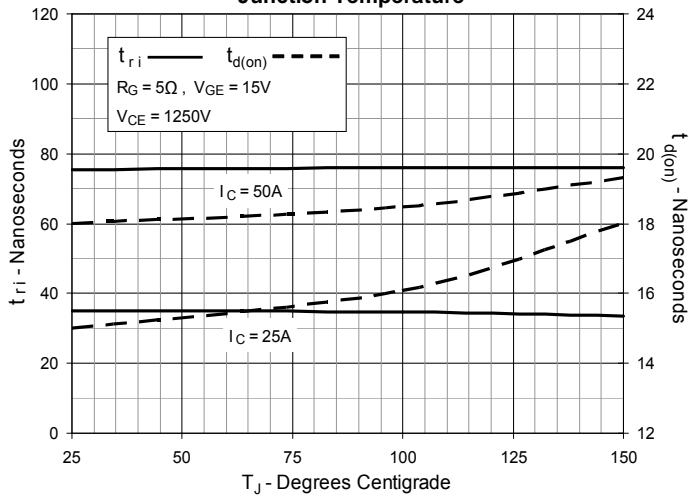

Fig. 21. Inductive Turn-on Switching Times vs. Junction Temperature





Disclaimer Notice - Information furnished is believed to be accurate and reliable. However, users should independently evaluate the suitability of and test each product selected for their own applications. Littelfuse products are not designed for, and may not be used in, all applications. Read complete Disclaimer Notice at www.littelfuse.com/disclaimer-electronics.