

55505 Series

Hall Effect Flange Mount Geartooth Speed Sensor

RoHS

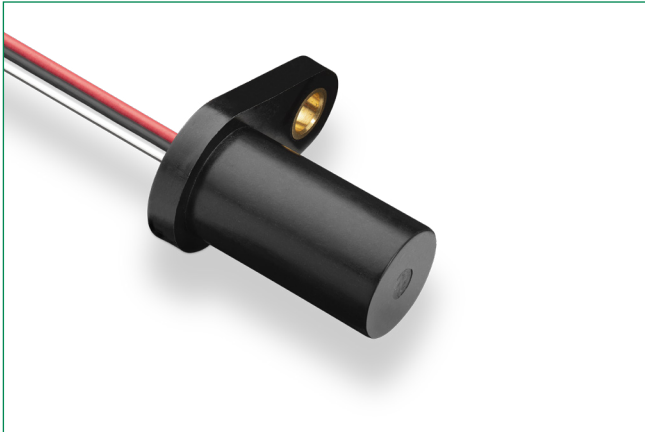

Description

The 55505 is a robust flange mounting hall effect sensor primarily for geartooth speed sensing. Protected against severe and automotive environments. It is capable of switching up to 27VDC and 25mA and is supplied as three-wire (voltage output) version. Its case design incorporates brass mounting bushing. It is ideally suited to wheel, transmission and camshaft speed sensing, gear-tooth sensing, rotary encoders, for use in industrial, commercial, and automotive applications.

Features & Benefits

- Ferrous target speed sensing
- Internal circuit protection
- Protection against severe and automotive environments
- Self adjusting magnetic range
- Automotive grade circuit protection
- High speed operation
- Short circuit and reverse voltage protection
- On board 10-bit A/D converter
- No chopper delay
- Immune to target run out
- Rotational alignment to target not critical
- IP67 rated

Additional Information



Resources



Accessories



Samples

Applications

- Wheel, transmission and camshaft speed sensing
- Geartooth sensor
- Rotary encoders
- Industrial
- Commercial
- Automotive

Dimensions

Dimensions in mm (inch)

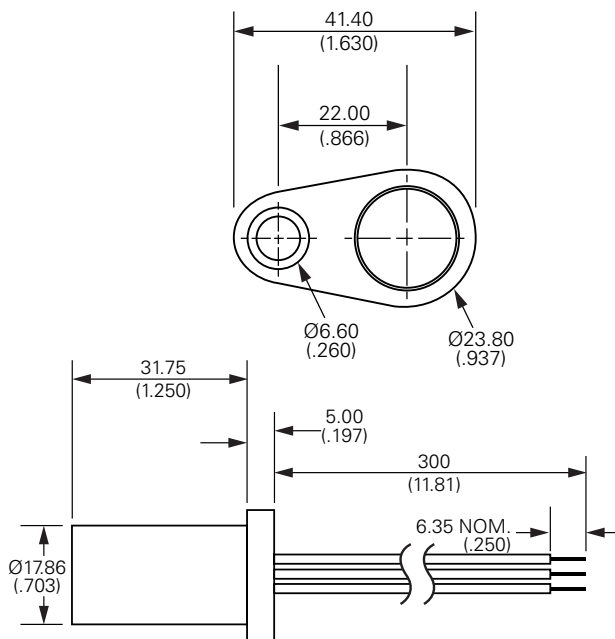

Application Example (Geartooth Sensor)

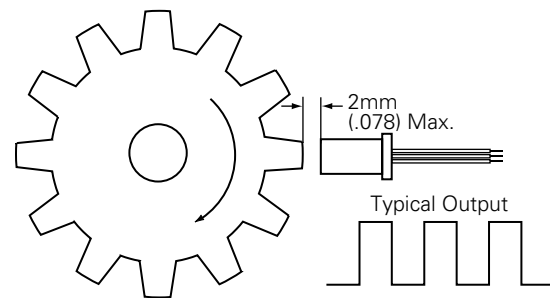

Block Diagram

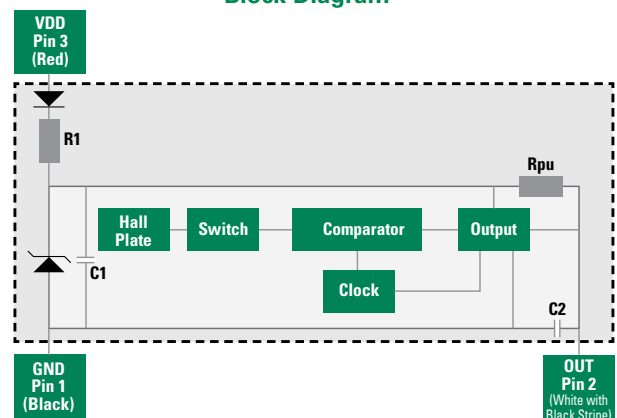

55505 Series

Hall Effect Flange Mount Geartooth Speed Sensor

Electrical Ratings



Hall Type	Digital Switch 3-Wire (Voltage Output)		
Supply Voltage ¹	Operate	Vdc	4.75 to 25.2
	Reverse Voltage		-25
	Overvoltage Protection	Vdc - max.	27
Output High Voltage		Vdc (max)	VDD - 2 (sinking output w/internal pull-up resistor)
Output Low Voltage		Vdc (max)	0.6 @ 25mA
Output Current (continuously on)		mA (max)	25
Current Consumption		mA (min)	1.0
		mA (max)	6.0
Switching Speed		kHz (max)	15
Temperature	Operating	°C	-40 to +125

Note: 1. As long as Tj (Junction Temperature) is not exceeded.

Cable Length Options

Cable Type: 20AWG 7/28 TXL 125C SAE J1128	
Select Option	Cable Length mm (inch)
02	300 (11.81)

Termination Options

Select Option	Description	
A	Tinned Leads	
B	Deutsch DTM04-3P	

Part Numbering System

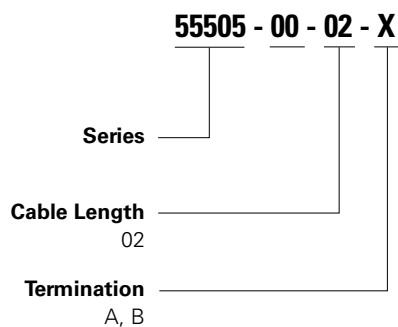

Packaging

Packaging Option	Packaging Specification	Quantity	Quantity & Packaging Code	Taping Width
Bulk	Bulk	500	N/A	N/A

Disclaimer Notice - Information furnished is believed to be accurate and reliable. However, users should independently evaluate the suitability of and test each product selected for their own applications. Littelfuse products are not designed for, and may not be used in, all applications. Read complete Disclaimer Notice at <http://www.littelfuse.com/disclaimer-electronics>.