

**Battrax® Protection Thyristor Series Single Port Positive/Negative - MS-013**

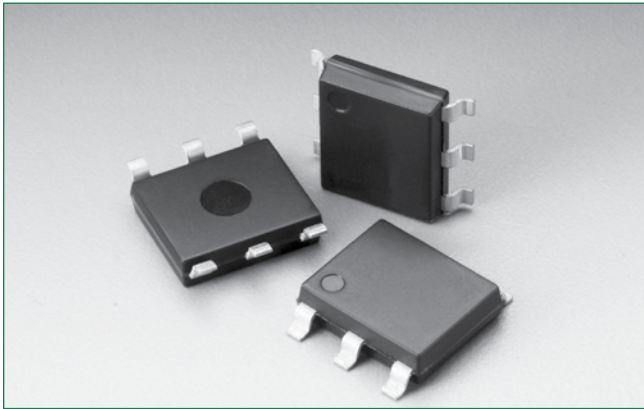

**Agency Approvals**

Agency	Agency File Number
	E133083

**Pinout Designation**



**Schematic Symbol**



**Description**

The Single Port Positive/Negative Battrax® Protection Thyristor Series are programmable SIDACTor® components designed to protect SLICs (Subscriber Line Interface Circuit) from damaging overvoltage transients.

This series is designed specifically to protect SLIC devices utilizing positive and negative ringing signals. This one device will protect a single port.

**Features and Benefits**

- Low voltage overshoot
- Low on-state voltage
- Does not degrade surge capability after multiple surge events within limit.
- Fails short circuit when surged in excess of ratings
- Low capacitance
- Positive and negative ringing compatible
- Single-port protect
- Gate trigger tracking device
- RoHS Compliant and Lead-Free
- Pb-free E3 means 2nd level interconnect is Pb-free and the terminal finish material is tin(Sn) (IPC/JEDEC J-STD-609A.01)
- Recognized to UL 497B as an Isolated Loop Circuit Protector

**Applicable Global Standards**

- TIA-968-A
- TIA-968-B
- ITU K.20/21 Enhanced Level
- ITU K.20/21 Basic Level
- GR 1089 Intra-building
- IEC 61000-4-5 2nd edition
- YD/T 1082
- YD/T 993
- YD/T 950

**Additional Information**



**Datasheet**



**Resources**



**Samples**

**Electrical Characteristics**

Part Number	Marking	$V_{DRM}$ @ $I_{DRM} = 5\mu A$	$V_S$ @ $100V/\mu s$	$I_H$	$I_S$	$I_T$	$V_T$ @ $I_T = 2.2$ Amps	Capacitance*	
		V min	V max	mA min	mA max	A max	V max	pF min	pF max
B3104UCLxx	B3104UC	$\pm V_{REF} + \pm 1.2V$	$\pm V_{REF} + \pm 10V$	100	100	2.2	4	30	200
B3164UCLxx	B3164UC	$\pm V_{REF} + \pm 1.2V$	$\pm V_{REF} + \pm 10V$	160	100	2.2	4	30	200
B3204UCLxx	B3204UC	$\pm V_{REF} + \pm 1.2V$	$\pm V_{REF} + \pm 10V$	200	100	2.2	4	30	200
B3104UALxx	B3104UA	$\pm V_{REF} + \pm 1.2V$	$\pm V_{REF} + \pm 10V$	100	100	2.2	4	30	200
B3164UALxx	B3164UA	$\pm V_{REF} + \pm 1.2V$	$\pm V_{REF} + \pm 10V$	100	100	2.2	4	30	200
B3204UALxx	B3204UA	$\pm V_{REF} + \pm 1.2V$	$\pm V_{REF} + \pm 10V$	100	100	2.2	4	30	200

**Notes:**

- Absolute maximum ratings measured at  $T_A = 25^\circ C$  (unless otherwise noted).
- Components are bi-directional
- All electrical characteristics shown are defined from Tip (pin 1) to Ground (pin 4 & 6) and Ring (pin 3) to Ground (pin 4 & 6)

- $V_{REF}$  Max Value for the negative BattraX is -200 V.
- $V_{REF}$  Max Value for the positive BattraX is +110 V.
- XX = Part Number Suffix: 'TP' (Tube Pack) or 'RP' (Reel Pack).
- \* Off-state capacitance ( $C_j$ ) is measured across pins 1 & 4,6 and 3 & 4,6 at 1 MHz with a 2V bias.

**Surge Ratings**

Series	$I_{PP}$									$I_{TSM}$ 50/60 Hz	di/dt
	0.2/310 <sup>1</sup> 0.5/700 <sup>2</sup>	2/10 <sup>1</sup> 2/10 <sup>2</sup>	8/20 <sup>1</sup> 1.2/50 <sup>2</sup>	10/160 <sup>1</sup> 10/160 <sup>2</sup>	10/560 <sup>1</sup> 10/560 <sup>2</sup>	5/320 <sup>1</sup> 9/720 <sup>2</sup>	10/360 <sup>1</sup> 10/360 <sup>2</sup>	10/1000 <sup>1</sup> 10/1000 <sup>2</sup>	5/310 <sup>1</sup> 10/700 <sup>2</sup>		
	A min	A min	A min	A min	A min	A min	A min	A min	A min	A min	A/μs max
<b>C</b>	50	500	400	200	150	200	175	100	200	50	500
<b>A</b>	20	150	150	90	50	75	75	45	75	20	500

**Notes:**

1. Current waveform in  $\mu s$
  2. Voltage waveform in  $\mu s$
- Peak pulse current rating ( $I_{PP}$ ) is repetitive and guaranteed for the life of the product that remains in thermal equilibrium.
  - $I_{PP}$  ratings applicable over temperature range of  $-40^\circ C$  to  $+85^\circ C$  ( $I_{PP}$  rating assumes  $V_{REF}$  equals +/- 48 V)
  - The component must initially be in thermal equilibrium with  $-40^\circ C \leq T_j \leq +150^\circ C$

**Thermal Considerations**

Package	Symbol	Parameter	Value	Unit
 Modified MS-013	$T_J$	Operating Junction Temperature Range	-40 to +125	$^\circ C$
	$T_S$	Storage Temperature Range	-65 to +150	$^\circ C$
	$R_{\theta JA}$	Thermal Resistance: Junction to Ambient	60	$^\circ C/W$

**V-I Characteristics**

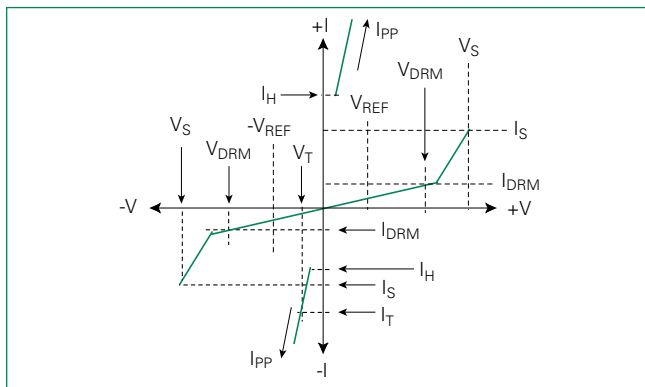

**$t_r \times t_d$  Pulse Waveform**

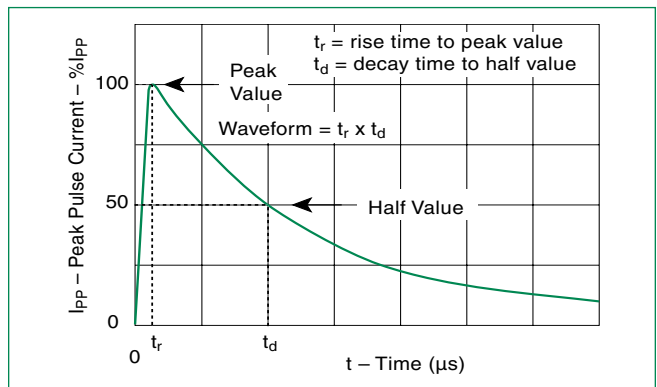

**Normalized  $V_S$  Change vs. Junction Temperature**

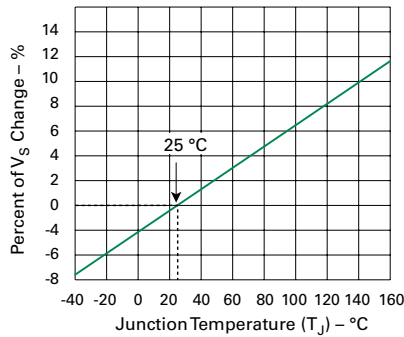

**Normalized DC Holding Current vs. Case Temperature**

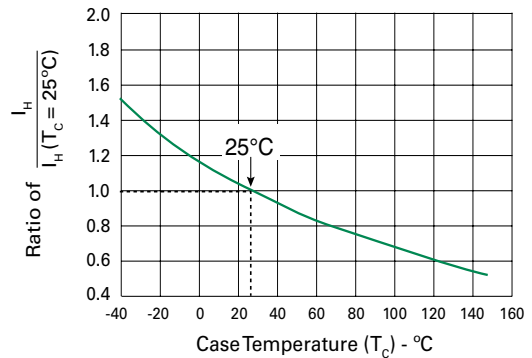

**Soldering Parameters**

<b>Reflow Condition</b>		Pb-Free assembly
<b>Pre Heat</b>	- Temperature Min ( $T_{s(\min)}$ )	+150°C
	- Temperature Max ( $T_{s(\max)}$ )	+200°C
	- Time (Min to Max) ( $t_s$ )	60-180 secs.
<b>Average ramp up rate (Liquidus Temp (<math>T_L</math>) to peak)</b>		3°C/sec. Max.
<b><math>T_{s(\max)}</math> to <math>T_L</math> - Ramp-up Rate</b>		3°C/sec. Max.
<b>Reflow</b>	- Temperature ( $T_L$ ) (Liquidus)	+217°C
	- Temperature ( $t_l$ )	60-150 secs.
<b>Peak Temp (<math>T_p</math>)</b>		+260(+0/-5)°C
<b>Time within 5°C of actual Peak Temp (<math>t_p</math>)</b>		30 secs. Max.
<b>Ramp-down Rate</b>		6°C/sec. Max.
<b>Time 25°C to Peak Temp (<math>T_p</math>)</b>		8 min. Max.
<b>Do not exceed</b>		+260°C

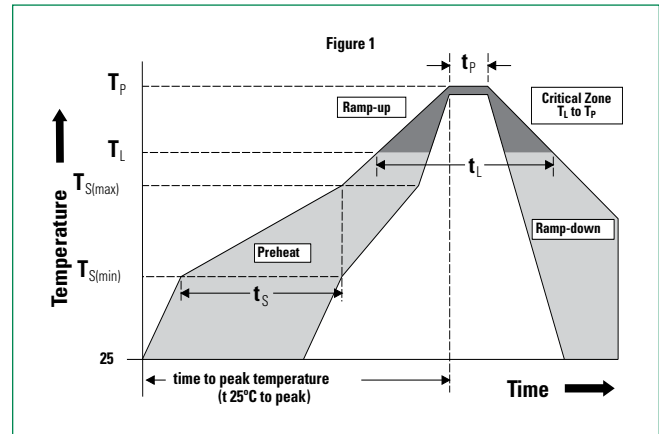

**Physical Specifications**

<b>Lead Material</b>	Copper Alloy
<b>Terminal Finish</b>	100% Matte-Tin Plated
<b>Body Material</b>	UL Recognized epoxy meeting flammability classification V-0

**Environmental Specifications**

<b>High Temp Voltage Blocking</b>	80% Rated $V_{DRM}$ ( $V_{DC}$ Peak) +125°C or +150°C, 504 or 1008 hrs. MIL-STD-750 (Method 1040) JEDEC, JESD22-A-101
<b>Temp Cycling</b>	-65°C to +150°C, 15 min. dwell, 10 up to 100 cycles. MIL-STD-750 (Method 1051) EIA/JEDEC, JESD22-A104
<b>Biased Temp &amp; Humidity</b>	52 $V_{DC}$ (+85°C) 85%RH, 504 up to 1008 hrs. EIA/JEDEC, JESD22-A-101
<b>High Temp Storage</b>	+150°C 1008 hrs. MIL-STD-750 (Method 1031) JEDEC, JESD22-A-101
<b>Low Temp Storage</b>	-65°C, 1008 hrs.
<b>Thermal Shock</b>	0°C to +100°C, 5 min. dwell, 10 sec. transfer, 10 cycles. MIL-STD-750 (Method 1056) JEDEC, JESD22-A-106
<b>Autoclave (Pressure Cooker Test)</b>	+121°C, 100%RH, 2atm, 24 up to 168 hrs. EIA/JEDEC, JESD22-A-102
<b>Resistance to Solder Heat</b>	+260°C, 30 secs. MIL-STD-750 (Method 2031)
<b>Moisture Sensitivity Level</b>	85%RH, +85°C, 168 hrs., 3 reflow cycles (+260°C Peak). JEDEC-J-STD-020, Level 1

**Part Numbering**

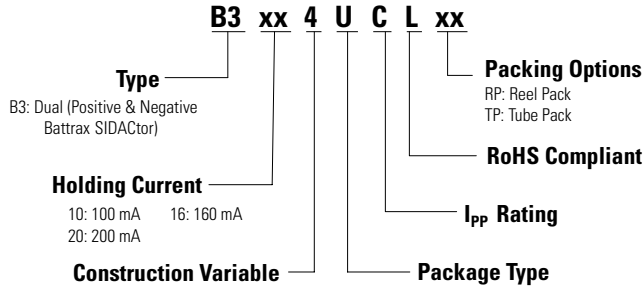

**Part Marking**

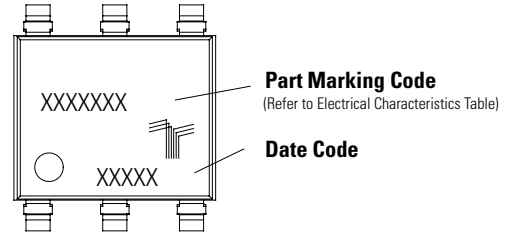

**Dimensions — MS-013**

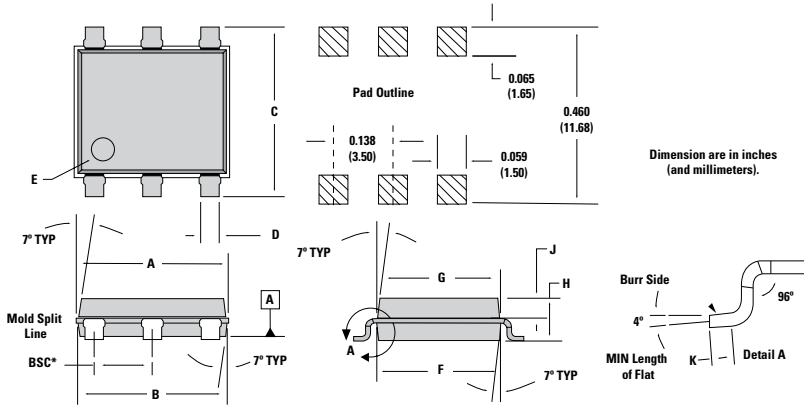

Dimensions	Inches		Millimeters	
	Min	Max	Min	Max
<b>A</b>	0.360	0.364	9.14	9.25
<b>B</b>	0.352	0.356	8.94	9.04
<b>C</b>	0.400	0.412	10.16	10.46
<b>D</b>	0.043	0.045	1.09	1.13
<b>E</b>	0.047	0.055	1.19	1.40
<b>F</b>	0.293	0.297	7.44	7.54
<b>G</b>	0.289	0.293	7.34	7.44
<b>H</b>	0.089	0.093	2.26	2.36
<b>J</b>	0.041	0.049	1.04	1.24
<b>K</b>	0.020		0.51	
<b>BSC*</b>	0.133	0.143	3.38	3.63

\* BSC = Basic Spacing between Centers

**Packing Options**

Package Type	Description	Quantity	Added Suffix	Industry Standard
U	Modified MS-013 6-pin Tape and Reel Pack	1500	RP	EIA-481-D
	Modified MS-013 6-pin Tube Pack	500 (50 per tube)	TP	N/A

**Tape and Reel Specification — MS-013**

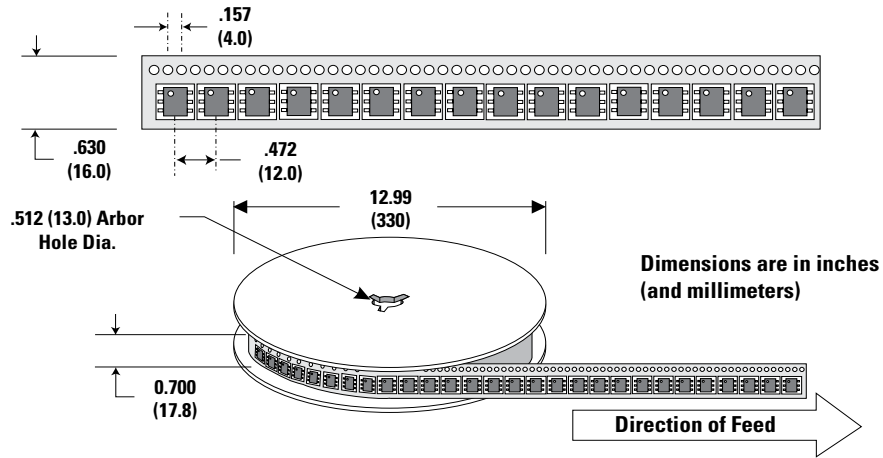

**Tube Pack Specification — MS-013**

