

# SESD Series

## Ultra Low Capacitance Discrete TVS

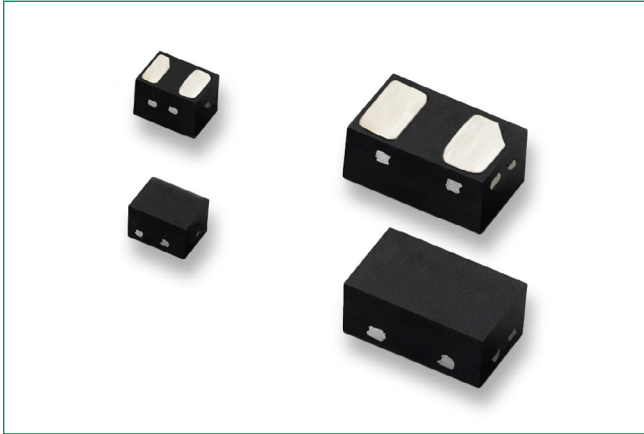

### Pinout

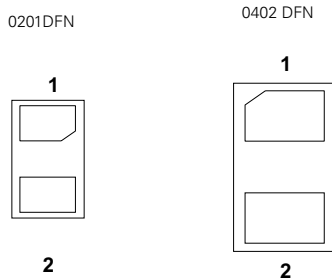

Bottom View

### Functional Block Diagram



Unidirectional

Bidirectional

### Description

The SESD Series Ultra Low Capacitance Discrete TVS provides unidirectional and bidirectional ESD protection for the most challenging high speed serial interfaces. Its low off-state capacitance, extremely low leakage (< 50 nA) and low dynamic resistance make it compatible with high speed signaling such as USB 3.1, HDMI 2.0, DisplayPort, and V-by-One®.

The SESD series has an ESD (IEC 61000-4-2) rating of  $\pm 20$  kV packaged in the industry's popular 0402 and 0201 footprints.

### Features

- 0.13pF MAX bidirectional off-state capacitance
- 0.25pF MAX unidirectional off-state capacitance
- IEC 61000-4-2 ESD rating of  $\pm 20$  kV air and contact discharge
- Low clamping voltage of 10V @  $I_{pp}=2A$  (Bidirectional) ( $t_p=8/20\mu s$ )
- PPAP capable
- Low profile 0201 and 0402 DFN packages
- Facilitates excellent signal integrity
- ELV-Compliant
- RoHS-Compliant and Lead-Free
- AEC-Q101 qualified

### Applications

- Ultra-high speed data lines
- USB 3.1, 3.0, 2.0
- HDMI 2.0, 1.4a, 1.3
- DisplayPort™
- Thunderbolt (Light Peak)
- V-by-One®
- LVDS interfaces
- Consumer, mobile and portable electronics
- Tablet PC and external storage with high speed interfaces
- Applications requiring high ESD performance in small packages

# SESD Series

## Ultra Low Capacitance Discrete TVS

### Absolute Maximum Ratings

Symbol	Parameter	Value	Units
$I_{PP}$	Peak Current ( $t_p=8/20\mu s$ )	2.0	A
$T_{OP}$	Operating Temperature	-55 to 125	°C
$T_{STOR}$	Storage Temperature	-55 to 150	°C

**Caution:** Stresses above those listed in "Absolute Maximum Ratings" may cause permanent damage to the component. This is a stress only rating and operation of the component at these or any other conditions above those indicated in the operational sections of this specification is not implied.

### Unidirectional Electrical Characteristics - ( $T_{OP}=25^\circ C$ )

Parameter	Test Conditions	Min	Typ	Max	Units
Input Capacitance	Reverse Bias=0V, $f = 3GHz$	-	0.20	0.25	pF
Breakdown Voltage	$V_{BR}$ @ $I_T=1mA$	-	9.00	-	V
Reverse Working Voltage	-	-	-	7.0	V
Reverse Leakage Current	$I_L$ @ $V_{RWM}=5.0V$	-	25	50	nA
Clamping Voltage	$V_{CL}$ @ $I_{PP}=2.0A$	-	9.20	-	V
ESD Withstand Voltage	IEC 61000-4-2 (Contact)	$\pm 20$	-	-	kV
	IEC 61000-4-2 (Air)	$\pm 20$	-	-	

### Bidirectional Electrical Characteristics - ( $T_{OP}=25^\circ C$ )

Parameter	Test Conditions	Min	Typ	Max	Units
Input Capacitance	Reverse Bias=0V, $f = 3GHz$	-	0.10	0.13	pF
Breakdown Voltage	$V_{BR}$ @ $I_T=1mA$	-	9.80	-	V
Reverse Working Voltage	-	-	-	7.0	V
Reverse Leakage Current	$I_L$ @ $V_{RWM}=5.0V$	-	25	50	nA
Clamping Voltage	$V_{CL}$ @ $I_{PP}=2.0A$	-	10.0	-	V
ESD Withstand Voltage	IEC 61000-4-2 (Contact)	$\pm 20$	-	-	kV
	IEC 61000-4-2 (Air)	$\pm 20$	-	-	

#### Insertion Loss Diagram - Unidirectional

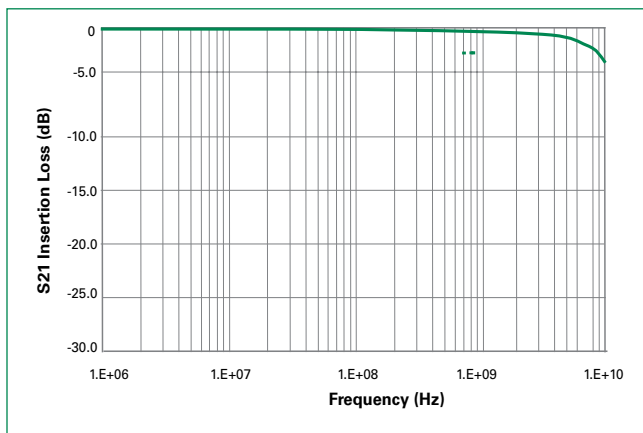

#### Insertion Loss Diagram - Bidirectional

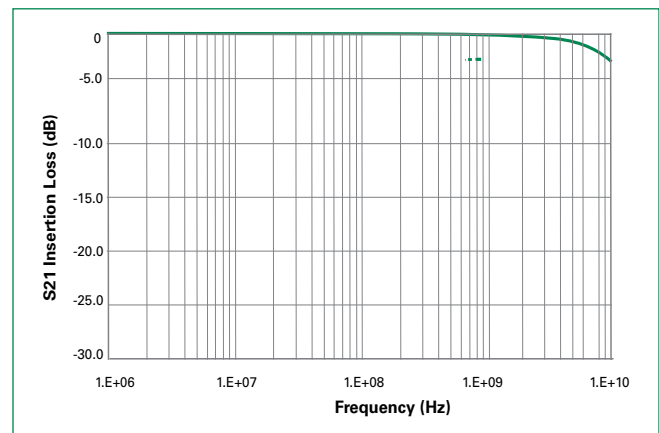

# SESD Series

## Ultra Low Capacitance Discrete TVS

### Component IV Curve - Unidirectional

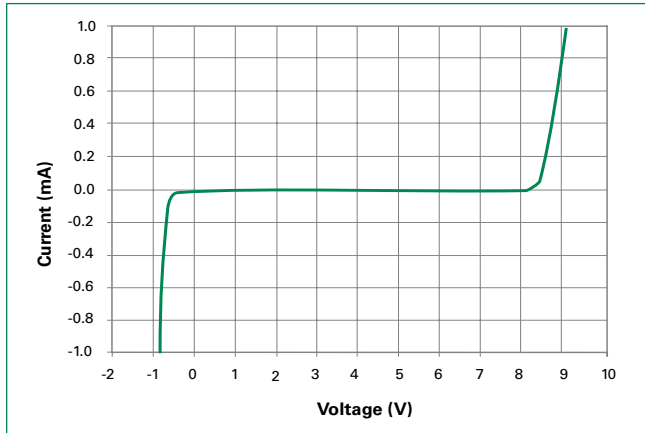

### Component IV Curve - Bidirectional

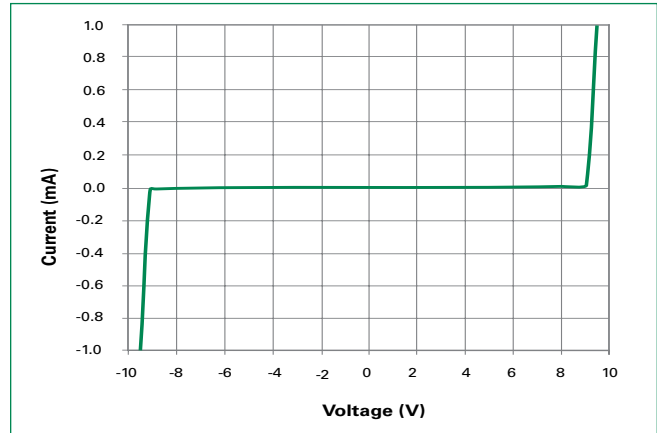

### USB3.0 Eye Diagram

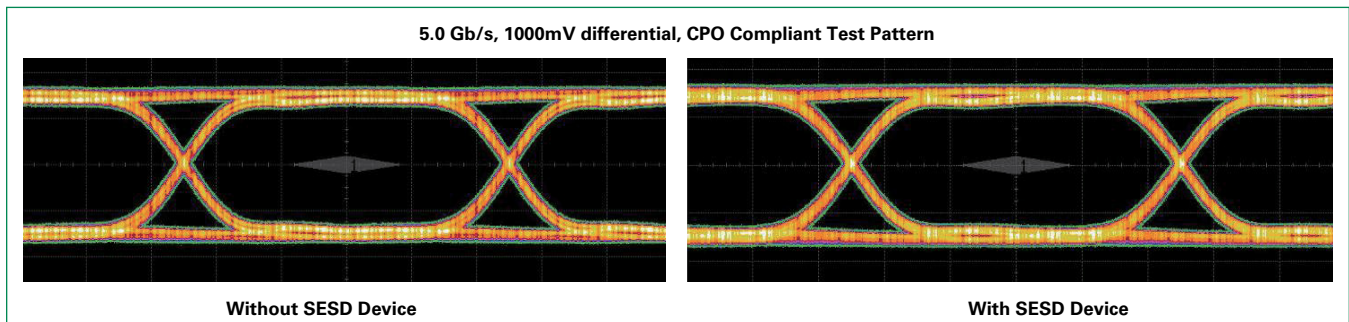

## Soldering Parameters

<b>Reflow Condition</b>		Pb – Free assembly
<b>Pre Heat</b>	- Temperature Min ( $T_{s(min)}$ )	150°C
	- Temperature Max ( $T_{s(max)}$ )	200°C
	- Time (min to max) ( $t_s$ )	60 – 120 secs
<b>Average ramp up rate (Liquidus) Temp (<math>T_L</math>) to peak</b>		3°C/second max
<b><math>T_{S(max)}</math> to <math>T_L</math> - Ramp-up Rate</b>		3°C/second max
<b>Reflow</b>	- Temperature ( $T_L$ ) (Liquidus)	217°C
	- Temperature ( $t_L$ )	60 – 150 seconds
<b>Peak Temperature (<math>T_p</math>)</b>		260 <sup>+0/-5</sup> °C
<b>Time within 5°C of actual peak Temperature (<math>t_p</math>)</b>		30 seconds
<b>Ramp-down Rate</b>		6°C/second max
<b>Time 25°C to peak Temperature (<math>T_p</math>)</b>		8 minutes Max.
<b>Do not exceed</b>		260°C

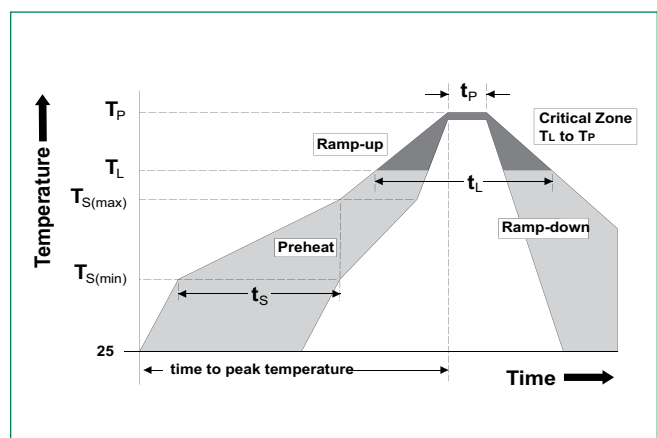

### Product Characteristics

<b>Lead Plating</b>	Pre-Plated Frame
<b>Lead Material</b>	Copper Alloy
<b>Substrate material</b>	Silicon
<b>Body Material</b>	Molded Compound
<b>Flammability</b>	UL Recognized compound meeting flammability rating V-0

# SESD Series

## Ultra Low Capacitance Discrete TVS

### Package Dimensions – 0201 DFN

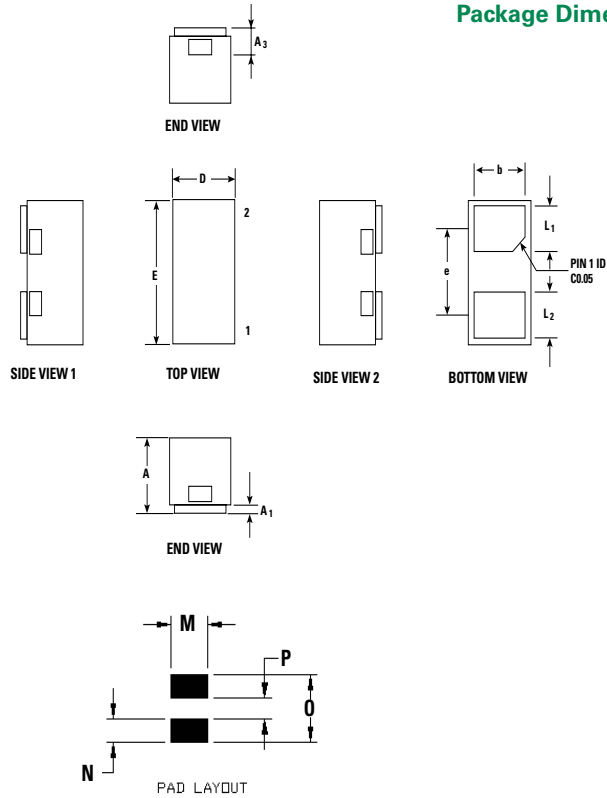

Symbol	Millimeters			Inches		
	Min	Typ	Max	Min	Typ	Max
A	0.28	0.30	0.32	0.011	0.012	0.013
A1	0	-	0.05	0	-	0.002
A3	0.102 ref.			0.004 ref.		
D	0.25	0.30	0.35	0.010	0.012	0.014
E	0.55	0.60	0.65	0.022	0.024	0.026
b	0.20	0.25	0.30	0.008	0.010	0.012
L1	0.13	0.18	0.23	0.005	0.008	0.009
L2	0.14	0.19	0.24	0.006	0.007	0.009
e	0.356 BSC			0.014 BSC		
M		0.32			0.013	
N		0.24			0.009	
O		0.62			0.024	
P		0.14			0.006	

### Package Dimensions – 0402 DFN

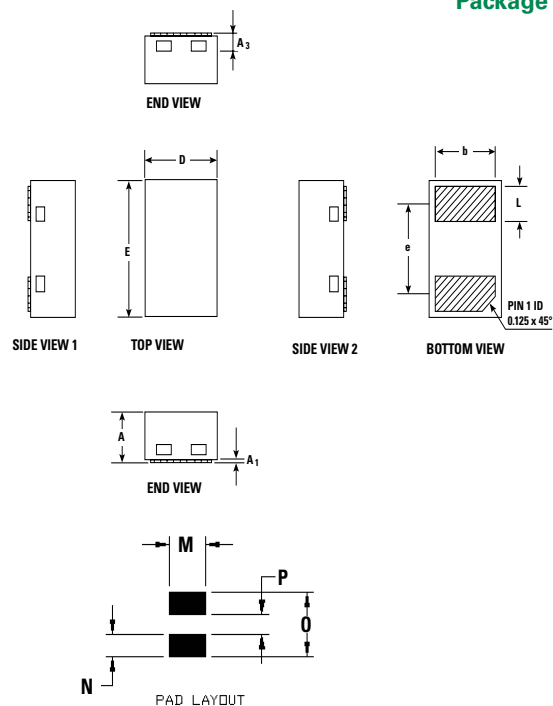

Symbol	Millimeters			Inches		
	Min	Typ	Max	Min	Typ	Max
A	0.31	0.38	0.43	0.013	0.015	0.017
A1	0	-	0.05	0	-	0.002
A3	0.13 ref.			0.005 ref.		
D	0.55	0.60	0.65	0.022	0.024	0.026
E	0.95	1.00	1.05	0.037	0.039	0.041
b	0.45	0.50	0.55	0.018	0.020	0.022
L	0.20	0.25	0.30	0.008	0.010	0.012
e	0.65 BSC			0.026 BSC		
M		0.60			0.024	
N		0.35			0.014	
O		1.00			0.039	
P		0.30			0.012	

# SESD Series

## Ultra Low Capacitance Discrete TVS

### Part Numbering System

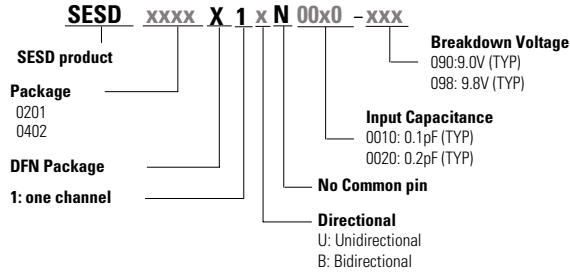

### Part Marking System

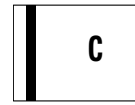

Unidirectional



Bidirectional

### Ordering Information

Part Number	Package	Ordering Part Number	Min. Order Qty.
SESD0201X1UN-0020-090	0201 DFN	RF2192-000	75000
SESD0201X1BN-0010-098	0201 DFN	RF2193-000	75000
SESD0402X1UN-0020-090	0402 DFN	RF2943-000	50000
SESD0402X1BN-0010-098	0402 DFN	RF2945-000	50000

### Embossed Carrier Tape & Reel Specification – 0201 DFN

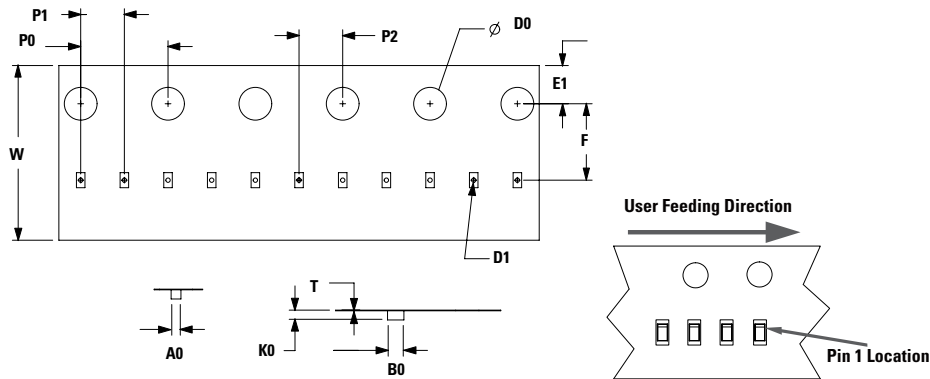

Symbol	Millimeters
<b>A0</b>	0.36+/-0.03
<b>B0</b>	0.66+/-0.03
<b>D0</b>	∅ 1.50 +0.10/- 0
<b>D1</b>	∅ 0.20 +/- 0.05
<b>E1</b>	1.75+/-0.10
<b>F</b>	3.50+/-0.05
<b>K0</b>	0.33+/-0.03
<b>P0</b>	4.00+/-0.10
<b>P1</b>	2.00+/-0.10
<b>P2</b>	2.00+/-0.05
<b>W</b>	8.00+/-0.10
<b>T</b>	0.23+/-0.02

### Embossed Carrier Tape & Reel Specification – 0402 DFN

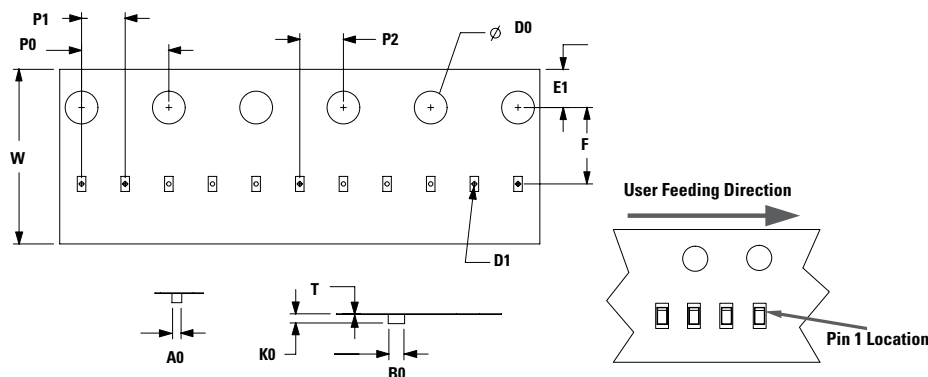

Symbol	Millimeters
<b>A0</b>	0.70+/-0.05
<b>B0</b>	1.15+/-0.05
<b>D0</b>	∅ 1.55 + 0.05
<b>D1</b>	∅ 0.40 +/- 0.05
<b>E1</b>	1.75+/-0.10
<b>F</b>	3.50+/-0.05
<b>K0</b>	0.47+/-0.05
<b>P0</b>	4.00+/-0.10
<b>P1</b>	2.00+/-0.10
<b>P2</b>	2.00+/-0.05
<b>W</b>	8.00+/-0.10
<b>T</b>	0.20+/-0.05

**Disclaimer Notice** - Information furnished is believed to be accurate and reliable. However, users should independently evaluate the suitability of and test each product selected for their own applications. Littelfuse products are not designed for, and may not be used in, all applications. Read complete Disclaimer Notice at: [www.littelfuse.com/disclaimer-electronics](http://www.littelfuse.com/disclaimer-electronics).