

**MCR8DCM, MCR8DCN**

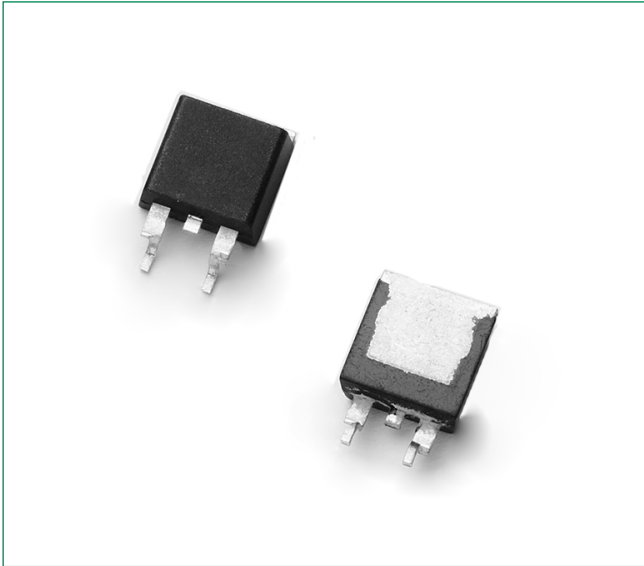

**Description**

Designed for high volume, low cost, industrial and consumer applications such as motor control; process control; temperature, light and speed control.

**Features**

- Small Size
  - Passivated Die for Reliability and Uniformity
  - Low Level Triggering and Holding Characteristics
  - Available in Two Package Styles Surface Mount Lead Form – Case 369C
  - Epoxy Meets UL 94 V-0 @ 0.125 in
  - ESD Ratings: Human
- Body Model, 3B > 8000 V  
Machine Model, C > 400 V
- Pb-Free Packages are Available

**Pin Out**

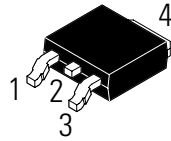

**Functional Diagram**

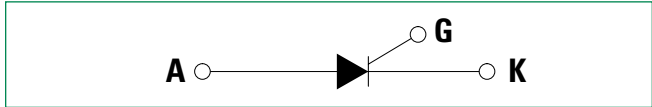

**Additional Information**



**Datasheet**



**Resources**



**Samples**

### Maximum Ratings ( $T_J = 25^\circ\text{C}$ unless otherwise noted)

Rating	Symbol	Value	Unit
Peak Repetitive Off-State Voltage (Note 1) (– 40 to 1125°C, Sine Wave, 50 to 60 Hz, Gate Open)	$V_{DRM}^*$ $V_{RRM}$	600 800	V
On-State RMS Current (180° Conduction Angles; $T_C = 105^\circ\text{C}$ )	$I_{T(RMS)}$	8.0	A
Average On-State Current (180° Conduction Angles; $T_C = 105^\circ\text{C}$ )	$I_{T(AV)}$	5.1	A
Peak Non-Repetitive Surge Current (1/2 Cycle, Sine Wave 60 Hz, $T_J = 110^\circ\text{C}$ )	$I_{TSM}$	80	A
Circuit Fusing Consideration ( $t = 8.3$ ms)	$I^2t$	26	A <sup>2</sup> sec
Forward Peak Gate Power (Pulse Width $\leq 10$ $\mu\text{sec}$ , $T_C = 105^\circ\text{C}$ )	$P_{GM}$	5.0	W
Forward Average Gate Power ( $t = 8.3$ msec, $T_C = 105^\circ\text{C}$ )	$P_{GM(AV)}$	0.5	W
Forward Peak Gate Current (Pulse Width $\leq 1.0$ $\mu\text{sec}$ , $T_C = 105^\circ\text{C}$ )	$I_{GM}$	2.0	A
Operating Junction Temperature Range	$T_J$	–40 to 125	°C
Storage Temperature Range	$T_{stg}$	–40 to 150	°C

Stresses exceeding Maximum Ratings may damage the device. Maximum Ratings are stress ratings only. Functional operation above the Recommended Operating Conditions is not implied. Extended exposure to stresses above the Recommended Operating Conditions may affect device reliability.

- $V_{DRM}^*$  and  $V_{RRM}$  for all types can be applied on a continuous basis. Ratings apply for zero or negative gate voltage; however, positive gate voltage shall not be applied concurrent with negative potential on the anode. Blocking voltages shall not be tested with a constant current source such that the voltage ratings of the devices are exceeded.

### Thermal Characteristics

Rating	Symbol	Value	Unit
Thermal Resistance, Junction-to-Case	$R_{\theta JC}$	2.2	°C/W
Thermal Resistance, Junction-to-Ambient	$R_{\theta JA}$	88	
Thermal Resistance, Junction-to-Ambient (Note 2)	$R_{\theta JA}$	80	
Maximum Device Temperature for Soldering Purposes (Note 3)	$T_L$	260	°C

### Electrical Characteristics - OFF ( $T_J = 25^\circ\text{C}$ unless otherwise noted)

Characteristic	Symbol	Min	Typ	Max	Unit	
Peak Repetitive Forward or Reverse Blocking Current (Note 3) ( $V_{AK} = \text{Rated } V_{DRM} \text{ or } V_{RRM}$ , $R_{GK} = 1.0$ k $\Omega$ )	$I_{DRM}^*$ $I_{RRM}$	$T_J = 25^\circ\text{C}$	–	–	0.01	mA
		$T_J = 125^\circ\text{C}$	–	–	5.0	

### Electrical Characteristics - ON ( $T_J = 25^\circ\text{C}$ unless otherwise noted; Electricals apply in both directions)

Characteristic	Symbol	Min	Typ	Max	Unit	
Peak On-State Voltage (Note 4) ( $I_{TM} = 16$ A)	$V_{TM}$	–	1.4	1.8	V	
Gate Trigger Current (Continuous dc) (Note 5) ( $V_{AK} = 12$ Vdc, $R_L = 100$ $\Omega$ )	$I_{GT}$	$(T_J = 25^\circ\text{C})$	2.0	7.0	15	$\mu\text{A}$
		$(T_J = -40^\circ\text{C})$	–	–	30	
Gate Trigger Voltage (Continuous dc) ( $V_D = 12$ V, $R_L = 100$ $\Omega$ ) ( $V_D = 12$ V, $R_L = 100$ $\Omega$ ) (Note 5)	$V_{GT}$	$(T_J = 25^\circ\text{C})$	0.5	0.65	1.0	V
		$(T_J = -40^\circ\text{C})$	–	–	2.0	
		$(T_J = 125^\circ\text{C})$	0.2	–	–	
Holding Current ( $V_D = 12$ V, Initiating Current = 200 mA, $R_{GK} = 1$ k $\Omega$ )	$I_H$	$(T_J = 25^\circ\text{C})$	4.0	22	30	mA
		$(T_J = -40^\circ\text{C})$	–	–	60	
Latching Current ( $V_D = 12$ V, $I_G = 2.0$ mA, $R_{GK} = 1$ k $\Omega$ )	$I_L$	$(T_J = 25^\circ\text{C})$	4.0	22	30	mA
		$(T_J = -40^\circ\text{C})$	–	–	60	

### Dynamic Characteristics

Characteristic	Symbol	Min	Typ	Max	Unit
Critical Rate of Rise of Off-State Voltage ( $V_{AK} = \text{Rated } V_{DRM}$ , Exponential Waveform, Gate Open, $T_J = 125^\circ\text{C}$ )	$dv/dt$	50	200	–	V/ $\mu\text{s}$
Critical Rate of Rise of On-State Current (IPK = 50 A, Pw = 40 sec, $di/dt = 1$ A/sec, $I_{gt} = 50$ mA)	$di/dt$	–	–	50	A/ms

- Surface mounted on minimum recommended pad size.
- 1/8" from case for 10 seconds.
- Pulse Test; Pulse Width  $\leq 2.0$  msec, Duty Cycle  $\leq 2\%$ .

**Voltage Current Characteristic of SCR**

Symbol	Parameter
$V_{DRM}$	Peak Repetitive Forward Off State Voltage
$I_{DRM}$	Peak Forward Blocking Current
$V_{RRM}$	Peak Repetitive Reverse Off State Voltage
$I_{RRM}$	Peak Reverse Blocking Current
$V_{TM}$	Maximum On State Voltage
$I_H$	Holding Current

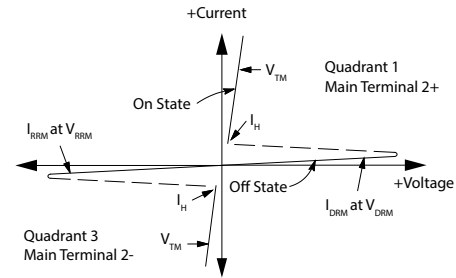

**Figure 1. Average Current Derating**

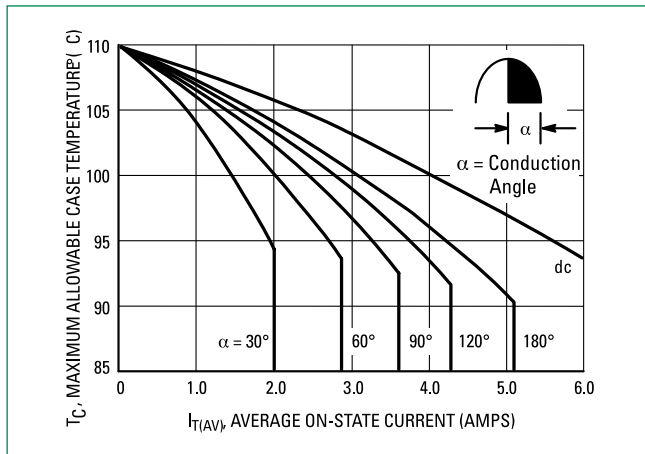

**Figure 2. On-State Power Dissipation**

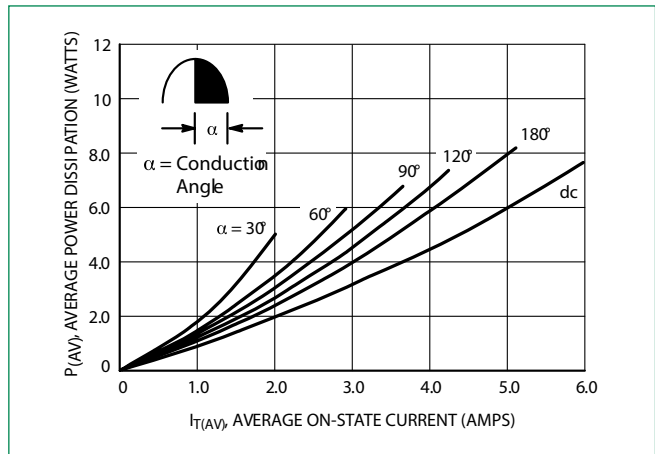

**Figure 3. On-State Characteristics**

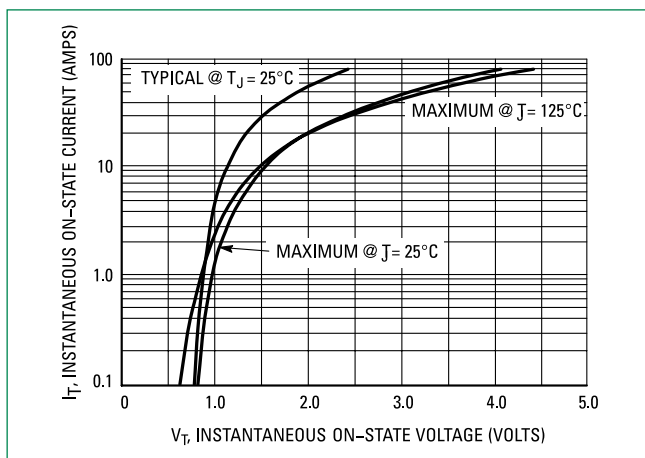

**Figure 4. Transient Thermal Response**

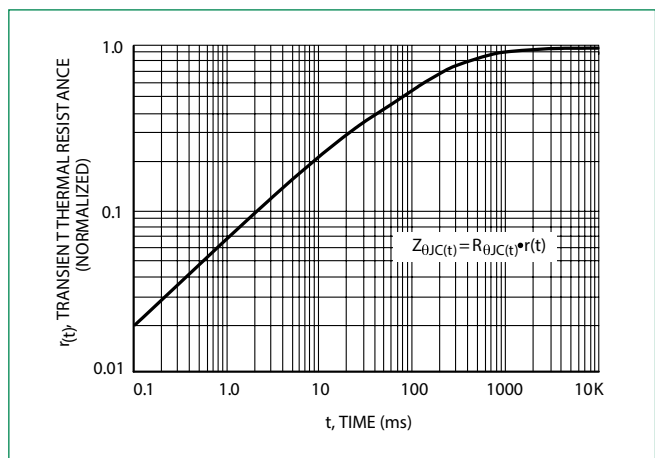

**Figure 5. Typical Gate Trigger Current vs Junction Temperature**

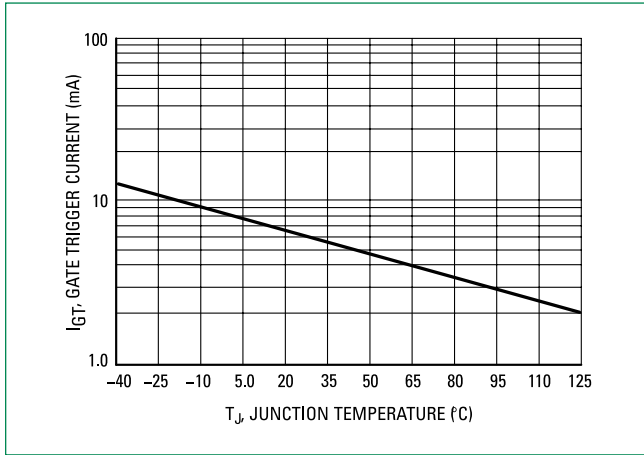

**Figure 6. Typical Gate Trigger Voltage vs Junction Temperature**

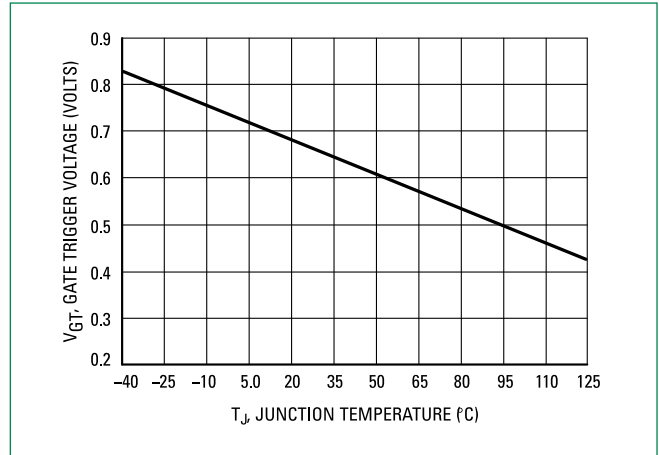

**Figure 7. Typical Holding Current vs Junction Temperature**

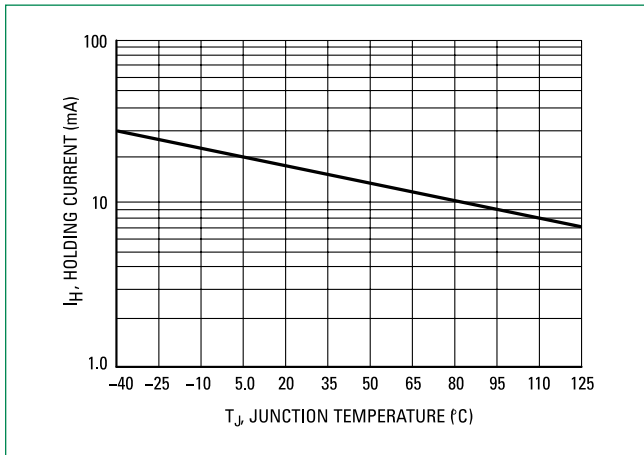

**Figure 8. Typical Latching Current vs Junction Temperature**

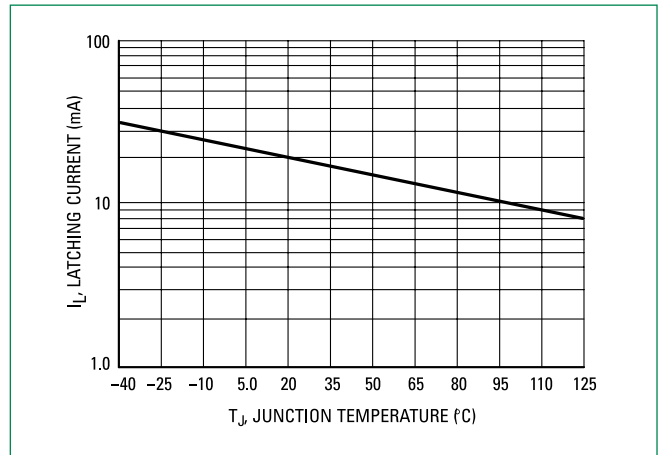

**Figure 9. Exponential Static dv/dt vs Gate-Cathode Resistance**

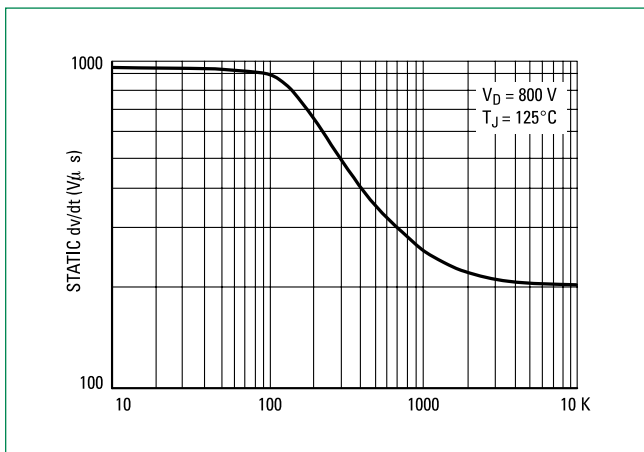

### Dimensions

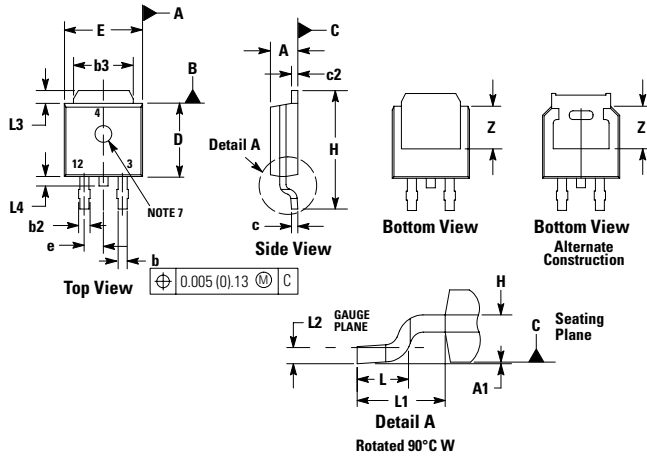

Dim	Inches		Millimeters	
	Min	Max	Min	Max
A	0.087	0.094	2.20	2.40
A1	0.000	0.005	0.00	0.12
b	0.022	0.030	0.55	0.75
b2	0.026	0.033	0.65	0.85
b3	0.209	0.217	5.30	5.50
c	0.019	0.023	0.49	0.59
c2	0.019	0.023	0.49	0.59
D	0.213	0.224	5.40	5.70
E	0.252	0.260	6.40	6.60
e	0.091		2.30	
H	0.374	0.406	9.50	10.30
L	0.058	0.070	1.47	1.78
L1	0.114		2.90	
L2	0.019	0.023	0.49	0.59
L3	0.053	0.065	1.35	1.65
L4	0.028	0.039	0.70	1.00
Z	0.154	-	3.90	-

1. DIMENSIONING AND TOLERANCING PER ANSI Y14.5M, 1982.  
2. CONTROLLING DIMENSION: INCH.

### Soldering Footprint

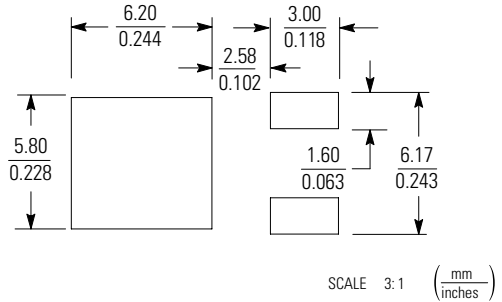

### Part Marking System

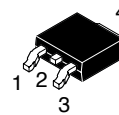

**DPAK-3**  
**Case 369C**  
**Style 4**

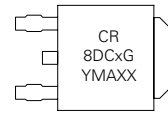

Y = Year  
M = Month  
A = Assembly Site  
AKA = Diode Polarity  
G = Pb-Free Package

### Pin Assignment

1	Cathode
2	Anode
3	Gate
4	Anode

### Ordering Information

Device	Package	Shipping
MCR8DSMT4	DPAK	2500 / Tape & Reel
MCR8DCMT4G	DPAK (Pb-Free)	
MCR8DCNT4	DPAK	
MCR8DCNT4G	DPAK (Pb-Free)	

**Disclaimer Notice** - Information furnished is believed to be accurate and reliable. However, users should independently evaluate the suitability of and test each product selected for their own applications. Littelfuse products are not designed for, and may not be used in, all applications. Read complete Disclaimer Notice at: [www.littelfuse.com/disclaimer-electronics](http://www.littelfuse.com/disclaimer-electronics)