

Parameter	Rating	Units
Breakdown Voltage - $BV_{CEO}$	30	$V_P$
Current Transfer Ratio CTR (Typical)	8500	%
Saturation Voltage - $V_{CE(sat)}$	1	V
Input Control Current - $I_F$	1	mA

### Features

- 100mA Continuous Load Rating
- 3750V<sub>rms</sub> Input/Output Isolation
- Bidirectional Input
- Small 8-Pin Package
- Flammability Rating UL 94 V-0
- Surface Mount Tape & Reel Version Available

### Applications

- Telecom Switching
- Tip/Ring Circuits
- Modem Switching (Laptop, Notebook, Pocket Size)
- Loop Detect
- Ringing Detect
- Current Sensing

### Description

LDA210 is a dual bidirectional-input optocoupler with Darlington-transistor outputs. The LDA210 has a minimum current transfer ratio (CTR) of 300% with a typical value of 8500%.

### Approvals

- UL Recognized Component: File E76270
- CSA Certified Component: Certificate # 1175739
- TUV EN 62368-1: Certificate # B 082667 0008

### Ordering Information

Part Number	Description
LDA210	8-Pin DIP (50/tube)
LDA210S	8-Pin Surface Mount (50/tube)
LDA210STR	8-Pin Surface Mount (1000/Reel)

### Pin Configuration

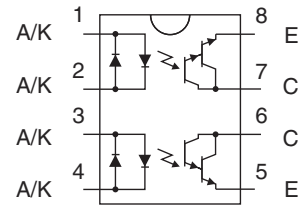

### Absolute Maximum Ratings @ 25°C

Parameter	Ratings	Units
Breakdown Voltage	30	V <sub>P</sub>
Input Control Current	100	mA
Peak (10ms)	1	A
Power Dissipation		
Input Power Dissipation <sup>1</sup>	150	mW
Phototransistor <sup>2</sup>	150	mW
Isolation Voltage, Input to Output	3750	V <sub>rms</sub>
Operational Temperature, Ambient	-40 to +85	°C
Storage Temperature	-40 to +125	°C

<sup>1</sup> Derate linearly 1.33mW / °C

<sup>2</sup> Derate linearly 2mW / °C

Absolute Maximum Ratings are stress ratings. Stresses in excess of these ratings can cause permanent damage to the device. Functional operation of the device at conditions beyond those indicated in the operational sections of this data sheet is not implied.

Typical values are characteristic of the device at +25°C, and are the result of engineering evaluations. They are provided for information purposes only, and are not part of the manufacturing testing requirements.

### Electrical Characteristics @ 25°C

Parameter	Conditions	Symbol	Min	Typ	Max	Units
<b>Output Characteristics</b>						
Phototransistor Breakdown Voltage	I <sub>C</sub> = 100μA	BV <sub>CEO</sub>	30	50	-	V
Phototransistor Dark Current	V <sub>CEO</sub> = 5V, I <sub>F</sub> = 0mA	I <sub>CEO</sub>	-	50	500	nA
Saturation Voltage	I <sub>C</sub> = 3mA, I <sub>F</sub> = 1mA	V <sub>CE(sat)</sub>	-	-	1	V
Current Transfer Ratio	I <sub>F</sub> = 1mA, V <sub>CE</sub> = 2V	CTR	300	8500	30000	%
Output Capacitance	50V, f = 1MHz	C <sub>OUT</sub>	-	3	-	pF
<b>Input Characteristics</b>						
Input Control Current	I <sub>C</sub> = 3mA, V <sub>CE</sub> = 2V	I <sub>F</sub>	-	0.07	1	mA
Input Voltage Drop	I <sub>F</sub> = 5mA	V <sub>F</sub>	0.9	1.2	1.5	V
<b>Common Characteristics</b>						
Capacitance, Input to Output	V <sub>IO</sub> = 0V, f = 1MHz	C <sub>IO</sub>	-	3	-	pF

### Switching Characteristics @ 25°C

Characteristic	Symbol	Test Condition	Typ	Units
Turn-On Time	t <sub>on</sub>	V <sub>CC</sub> = 5V, I <sub>F</sub> = 1mA, R <sub>L</sub> = 500Ω	8	μs
Turn-Off Time	t <sub>off</sub>		345	

Switching Time Test Circuit

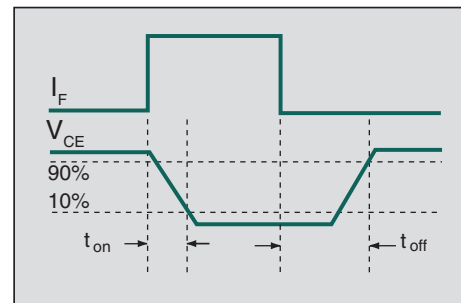
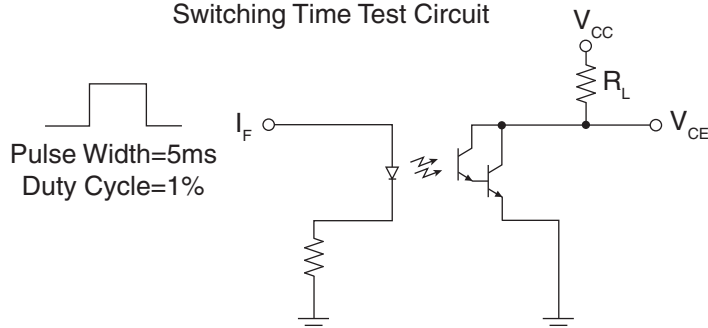

**PERFORMANCE DATA\***

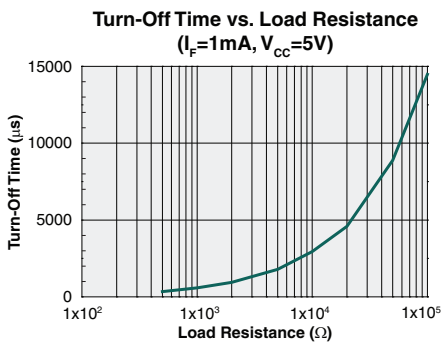
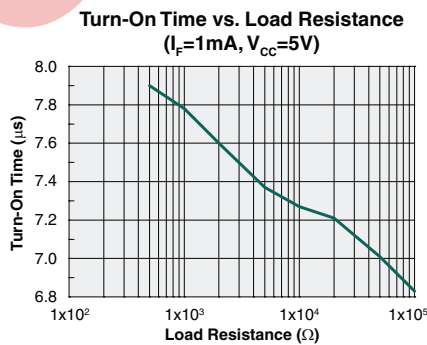
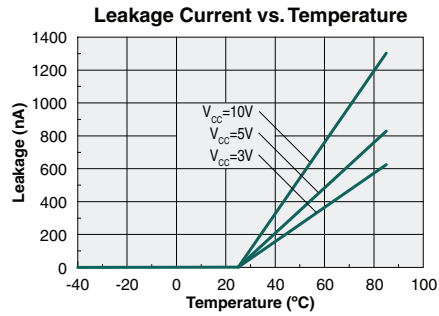
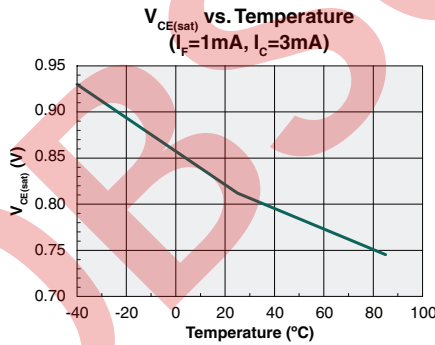
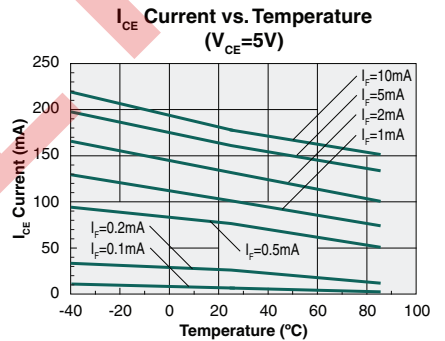
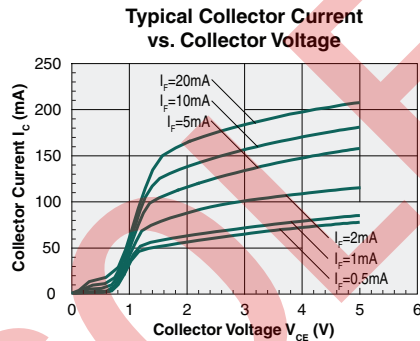
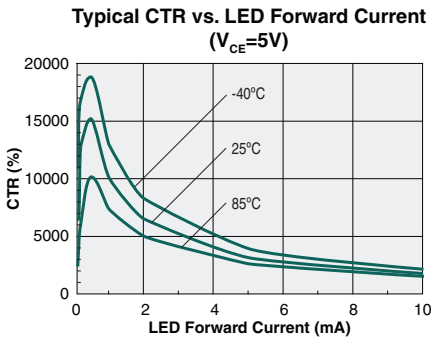
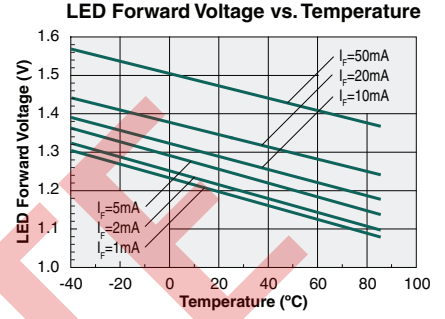
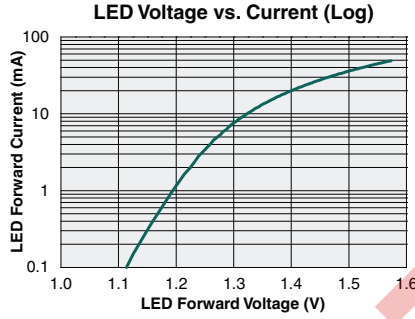
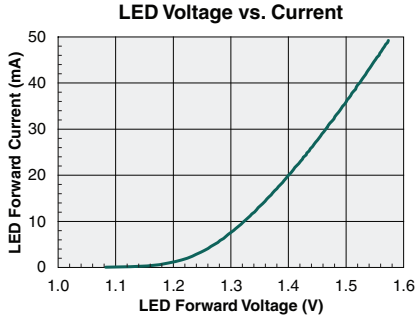

\* Unless otherwise noted, data presented in these graphs is typical of device operation at  $25^\circ\text{C}$ .

## Manufacturing Information

### Moisture Sensitivity



All plastic encapsulated semiconductor packages are susceptible to moisture ingress. IXYS Integrated Circuits classifies its plastic encapsulated devices for moisture sensitivity according to the latest version of the joint industry standard, **IPC/JEDEC J-STD-020**, in force at the time of product evaluation. We test all of our products to the maximum conditions set forth in the standard, and guarantee proper operation of our devices when handled according to the limitations and information in that standard as well as to any limitations set forth in the information or standards referenced below.

Failure to adhere to the warnings or limitations as established by the listed specifications could result in reduced product performance, reduction of operable life, and/or reduction of overall reliability.

This product carries a **Moisture Sensitivity Level (MSL)** classification as shown below, and should be handled according to the requirements of the latest version of the joint industry standard **IPC/JEDEC J-STD-033**.

Device	Moisture Sensitivity Level (MSL) Classification
LDA210S	MSL 1

### ESD Sensitivity



This product is ESD Sensitive, and should be handled according to the industry standard **JESD-625**.

### Soldering Profile

Provided in the table below is the **IPC/JEDEC J-STD-020** Classification Temperature ( $T_C$ ) and the maximum total dwell time ( $t_p$ ) in all reflow processes that the body temperature of these surface mount devices may be ( $T_C - 5$ )°C or greater. The device's body temperature must not exceed the Classification Temperature at any time during reflow soldering processes.

Device	Classification Temperature ( $T_C$ )	Dwell Time ( $t_p$ )	Max Reflow Cycles
LDA210S	250°C	30 seconds	3

For through-hole devices, the maximum pin temperature and maximum dwell time through all solder waves is provided in the table below. Dwell time is the interval beginning when the pins are initially immersed into the solder wave until they exit the solder wave. For multiple waves, the dwell time is from entering the first wave until exiting the last wave. During this time, pin temperatures must not exceed the maximum temperature given in the table below. Body temperature of the device must not exceed the limit shown in the table below at any time during the soldering process.

Device	Maximum Pin Temperature	Maximum Body Temperature	Maximum Dwell Time	Wave Cycles
LDA210	260°C	250°C	10 seconds*	1

\*Total cumulative duration of all waves.

### Board Wash

IXYS Integrated Circuits recommends the use of no-clean flux formulations. Board washing to reduce or remove flux residue following the solder reflow process is acceptable provided proper precautions are taken to prevent damage to the device. These precautions include but are not limited to: using a low pressure wash and providing a follow up bake cycle sufficient to remove any moisture trapped within the device due to the washing process. Due to the variability of the wash parameters used to clean the board, determination of the bake temperature and duration necessary to remove the moisture trapped within the package is the responsibility of the user (assembler). Cleaning or drying methods that employ ultrasonic energy may damage the device and should not be used. Additionally, the device must not be exposed to halide flux or solvents.



**Mechanical Dimensions**

**LDA210**

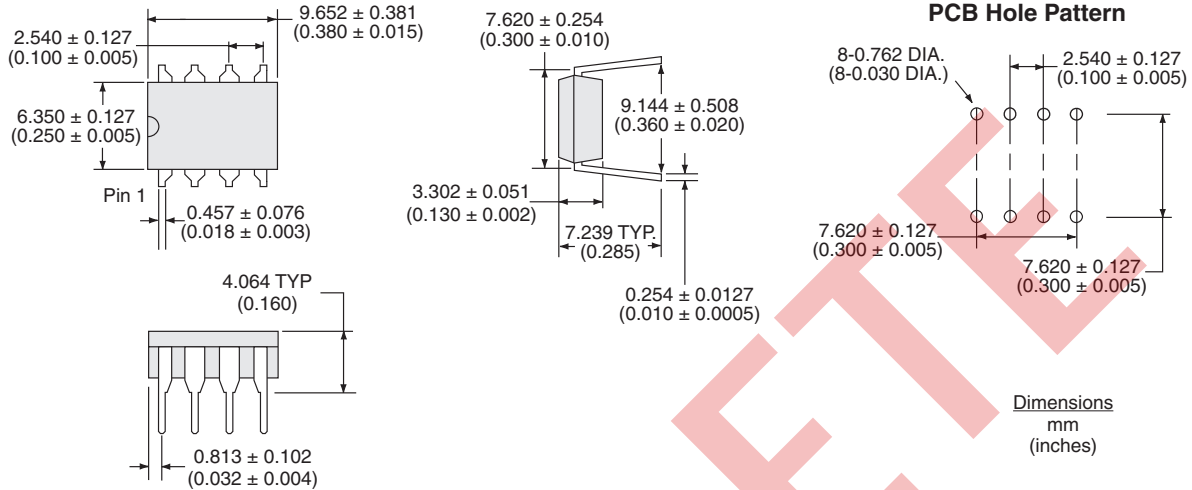

**LDA210S**

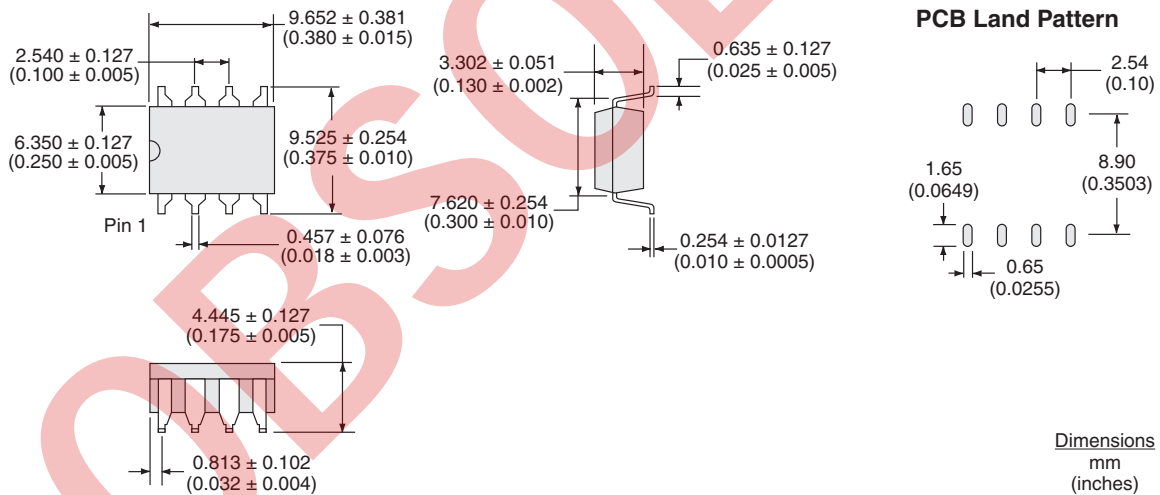

LDA210STR Tape & Reel

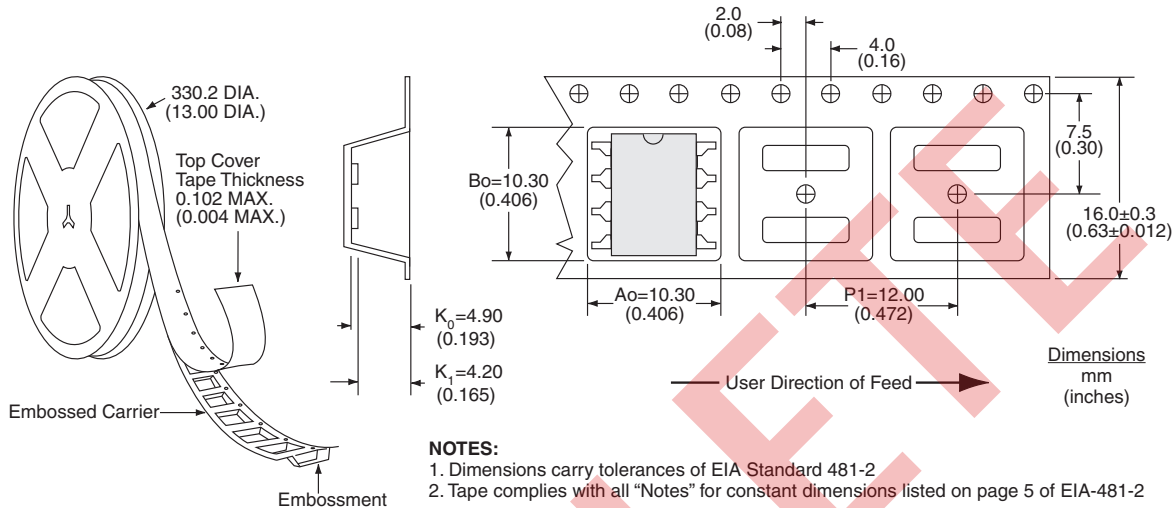

OBSOLETE

For additional information please visit our website at: <https://www.ixysic.com>