

SG Series



**Description**

Littelfuse SG series GDT offers high surge ratings in a miniature package. It's designed for surface mounting on PCB with small size 4.5x3.2x2.7mm. Low insertion loss is perfectly suited to broadband equipment applications. The capacitance does not vary with voltage, and will not cause operational problems with ADSL2+, where capacitance variation across Tip and Ring is undesirable. These devices are extremely robust and are able to divert a 1000A pulse without destruction.

**Agency Approvals**

Agency	Agency File Number
	E128662

**2 Electrode GDT Graphical Symbol**

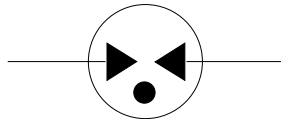

**Features**

- RoHS compliant and Lead-free
- GHz working frequency
- Excellent stability on multiple pulse duty cycle
- Excellent response to fast rising transients.
- Ultra Low Insertion Loss
- 1-2KA surge capability tested with 8/20µS pulse as defined by IEC 61000-4-5
- Ultra small devices offered in a variety of mounting lead forms
- Non-Radioactive
- Low capacitance (<1pF)
- Voltage Ranges 75V to 600V
- UL Recognized
- Conforms to ITU-T K12, IEC 61000-4-5
- Square Outline

**Additional Information**



Datasheet



Resources



Samples

**Applications**

- Communication equipment
- CATV equipment
- Test equipment
- Data lines
- Power supplies
- Telecom SLIC protection
- Broadband equipment
- ADSL equipment, including ADSL2+
- XDSL equipment
- Satellite and CATV equipment
- General telecom equipment

### Electrical Characteristics

Part Number	Device Specifications (at 25°C)										Life Ratings		
	DC Breakdown in Volts (@100V/s)			Impulse Breakdown in Volts (@100V/μs)	Impulse Breakdown In Volts (@1 Kv/μsec)	Insulation Resistance	Capacitance (@1MHz)	Arc Voltage (@1A)	Glow to Arc Transition Current	Glow Voltage	Nominal AC Discharge Current (x10 @50Hz)	Nominal Impulse Discharge Current (x10 @8/20μs)	Nominal Impulse Discharge Current (10/1000μs 100 cycles)
	Min.	Typ.	Max.	Max.	Min.	Max.							
SG75	52	75	98	500	650	>1GΩ (at 50VDC)	<1 pf	~10 V	~1.0 A	~60 V	2 A	2kA	10 A
SG90	63	90	117	500	600								
SG150	105	150	195	500	600								
SG200*	140	200	260	550	700	>1GΩ (at 100VDC)	<0.8 pf	~12 V	~0.5 A	~140 V	2.5 A		
SG230	172	230	288	650	800								
SG300	225	300	375	700	850								
SG300Q	210	300	390	580	650	>1GΩ (at 50VDC)	<0.8 pf	~20 V	~0.8 A	~140 V	NA*		
SG350	263	350	437	750	900								
SG350Q	263	350	437	600	700								
SG400	300	400	500	800	950	>1GΩ (at 100VDC)	<1 pf	~10 V	~1.0 A	~60 V	2 A		
SG420	315	420	525	800	1000								
SG420Q	315	420	525	650	750								
SG450Q	370	450	500	680	750	>1GΩ (at 100VDC)	<0.5 pf	~20 V	~0.1 A	~140 V	1 A		
SG500Q	400	500	600	950	1050								
SG600Q	450	600	750	1100	1200								

\* Specification is not applicable for quick response (SGxxxQ) version of product  
+ Not UL Recognized

### Product Characteristics

<b>Materials</b>	Device Tin Plated 17.5±12.5 Microns Construction Ceramic Insulator.
<b>Storage and Operational Temperature</b>	-40 to +90 °C

### Typical Insertion Loss

	@ 1.0 GHz = 0.01 dB
	@ 1.4GHz = 0.1 dB
	@ 1.8 GHz = 0.53 dB
	@ 2.1 GHz = 0.81 dB
	@ 2.45 GHz = 1 dB
	@ 2.8 GHz = 1.2 dB
	@ 3.1 GHz = 1.5 dB
	@ 3.5 GHz = 2.1 dB

### Voltage vs. Time Characteristic

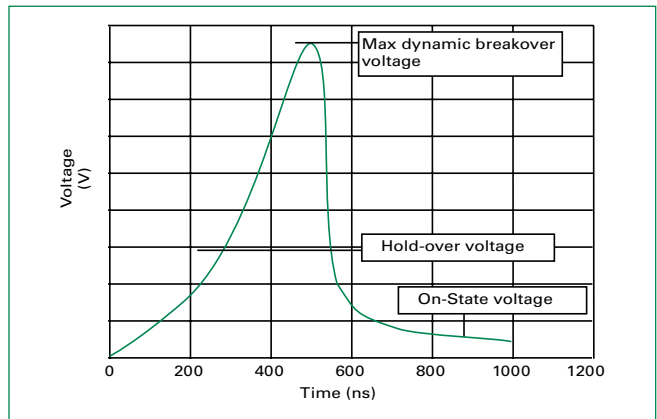

**Soldering Parameters - Reflow Soldering (Surface Mount Devices)**

<b>Reflow Condition</b>		Pb – Free assembly
<b>Pre Heat</b>	- Temperature Min ( $T_{s(min)}$ )	150°C
	- Temperature Max ( $T_{s(max)}$ )	200°C
	- Time (Min to Max) ( $t_s$ )	60 – 180 secs
<b>Average ramp up rate (Liquidus Temp (<math>T_L</math>) to peak)</b>		3°C/second max
<b><math>T_{s(max)}</math> to <math>T_L</math> - Ramp-up Rate</b>		5°C/second max
<b>Reflow</b>	- Temperature ( $T_L$ ) (Liquidus)	217°C
	- Temperature ( $t_L$ )	60 – 150 seconds
<b>Peak Temperature (<math>T_p</math>)</b>		260 <sup>+0/-5</sup> °C
<b>Time within 5°C of actual peak Temperature (<math>t_p</math>)</b>		10 – 30 seconds
<b>Ramp-down Rate</b>		6°C/second max
<b>Time 25°C to peak Temperature (<math>T_p</math>)</b>		8 minutes Max.
<b>Do not exceed</b>		260°C

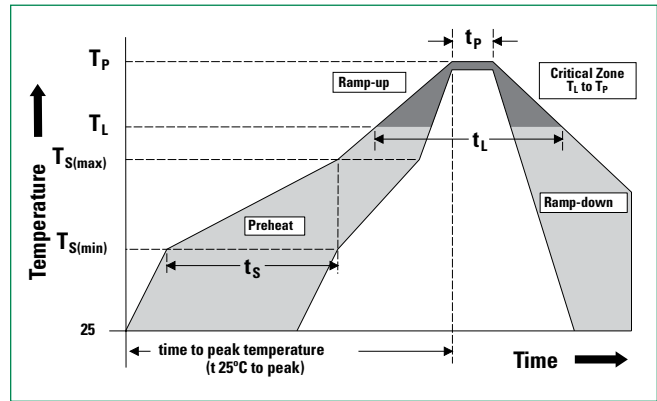

**Device Dimensions**

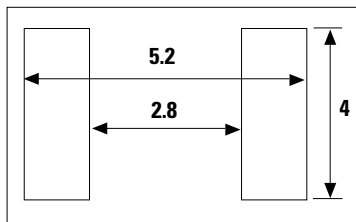
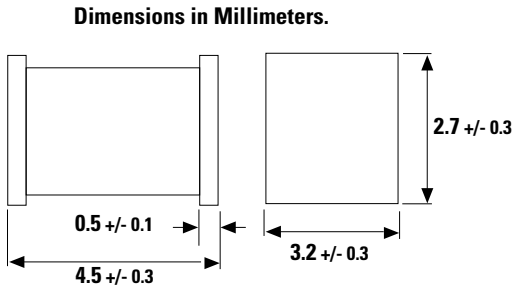

**Recommended Soldering Pad Layout**

**Device Marking**

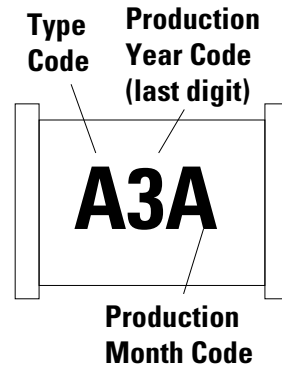

Type Code	
A	SG75
B	SG90
C	SG150
D	SG230
E	SG300
F	SG300Q
G	SG350
H	SG350Q
I	SG400
J	SG420
K	SG420Q
L	SG450Q
M	SG500Q
N	SG600Q
O	SG200

Month Code	
A	January
B	February
C	March
D	April
E	May
F	June
G	July
H	August
I	September
J	October
K	November
L	December

## Tape and Reel Dimensions (IEC 60286-3, dimension in mm)

### Tape Specifications

IEC 60286-3  
Dimensions in mm

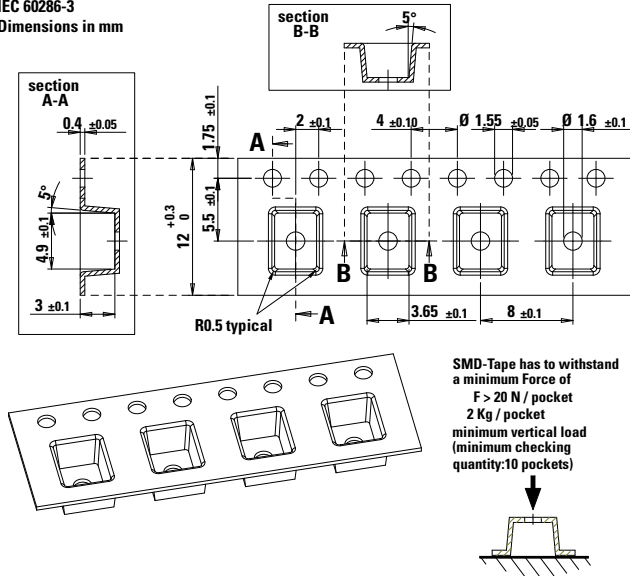

## Part Numbering System and Ordering Information

**SG xxx Q**

Series

Square GDT

Breakdown Voltage

- 75 = 75V
- 90 = 90V
- 150 = 150V
- 200 = 200V
- 230 = 230V
- 300 = 300V
- 350 = 350V
- 400 = 400V
- 420 = 420V
- 450 = 450V (Not available without "Q" suffix)
- 500 = 500V (Not available without "Q" suffix)
- 600 = 600V (Not available without "Q" suffix)

Device Option Code

- (Blank) = Standard device
- Q** = Quick Response Version (300V, 350V, 420V, 450V, 500V, 600V only)

### Reel Specifications

IEC 60286-3  
Dimensions in mm

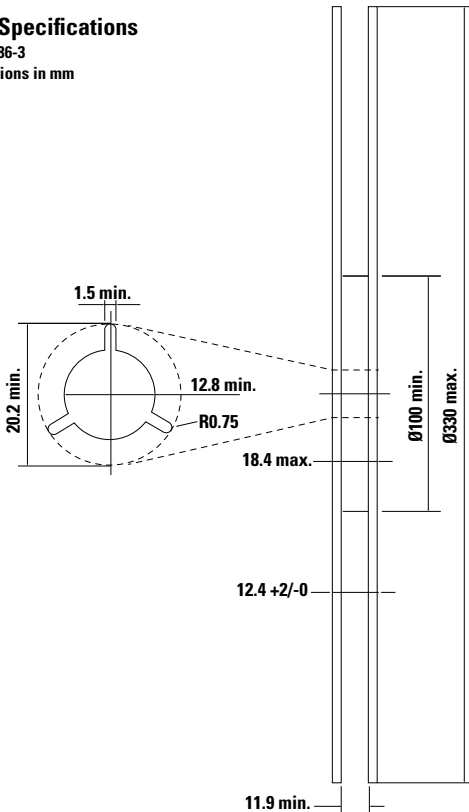

## Packaging

Part Number and Device Type	Quantity and Packaging Description
SGxxx	Surface mount 2000pcs/reel in tape and reel