

X2-Class HiPerFET™ Power MOSFET

IXFA18N65X2
IXFP18N65X2
IXFH18N65X2

V_{DSS} = 650V
I_{D25} = 18A
R_{DS(on)} ≤ 200mΩ

N-Channel Enhancement Mode
Avalanche Rated



| Symbol | Test Conditions | Maximum Ratings | |
|-------------------|--|--------------------|----------|
| V _{DSS} | T _J = 25°C to 150°C | 650 | V |
| V _{DGR} | T _J = 25°C to 150°C, R _{GS} = 1MΩ | 650 | V |
| V _{GSS} | Continuous | ±30 | V |
| V _{GSM} | Transient | ±40 | V |
| I _{D25} | T _C = 25°C | 18 | A |
| I _{DM} | T _C = 25°C, Pulse Width Limited by T _{JM} | 22 | A |
| I _A | T _C = 25°C | 4 | A |
| E _{AS} | T _C = 25°C | 300 | mJ |
| dv/dt | I _S ≤ I _{DM} , V _{DD} ≤ V _{DSS} , T _J ≤ 150°C | 50 | V/ns |
| P _D | T _C = 25°C | 290 | W |
| T _J | | -55 ... +150 | °C |
| T _{JM} | | 150 | °C |
| T _{stg} | | -55 ... +150 | °C |
| T _L | Maximum Lead Temperature for Soldering | 300 | °C |
| T _{SOLD} | 1.6 mm (0.062in.) from Case for 10s | 260 | °C |
| F _C | Mounting Force (TO-263) | 10..65 / 2.2..14.6 | N/lb |
| M _d | Mounting Torque (TO-220 & TO-247) | 1.13 / 10 | Nm/lb.in |
| Weight | TO-263 | 2.5 | g |
| | TO-220 | 3.0 | g |
| | TO-247 | 6.0 | g |

TO-263
(IXFA)

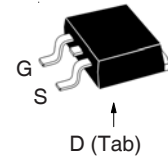

TO-220
(IXFP)

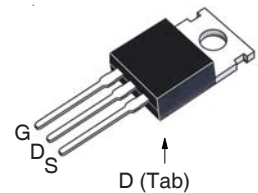

TO-247
(IXFH)

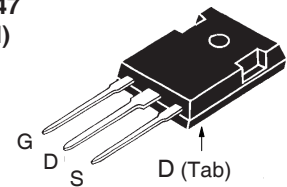

G = Gate D = Drain
S = Source Tab = Drain

Features

- International Standard Packages
- Low R_{DS(ON)} and Q_G
- Avalanche Rated
- Low Package Inductance

Advantages

- High Power Density
- Easy to Mount
- Space Savings

Applications

- Switch-Mode and Resonant-Mode Power Supplies
- DC-DC Converters
- PFC Circuits
- AC and DC Motor Drives
- Robotics and Servo Controls

| Symbol | Test Conditions (T _J = 25°C, Unless Otherwise Specified) | Characteristic Values | | |
|---------------------|---|-----------------------|------|-----------------|
| | | Min. | Typ. | Max. |
| BV _{DSS} | V _{GS} = 0V, I _D = 250μA | 650 | | V |
| V _{GS(th)} | V _{DS} = V _{GS} , I _D = 1.5mA | 3.0 | | 5.0 V |
| I _{GSS} | V _{GS} = ±30V, V _{DS} = 0V | | | ±100 nA |
| I _{DSS} | V _{DS} = V _{DSS} , V _{GS} = 0V T _J = 125°C | | | 25 μA 1.5 mA |
| R _{DS(on)} | V _{GS} = 10V, I _D = 0.5 • I _{D25} , Note 1 | 164 | | 200 mΩ |

| Symbol | Test Conditions ($T_J = 25^\circ\text{C}$, Unless Otherwise Specified) | Characteristic Values | | |
|-------------------------------------|---|--|------|-------------------------|
| | | Min. | Typ. | Max |
| g_{fs} | $V_{DS} = 10\text{V}$, $I_D = 0.5 \cdot I_{D25}$, Note 1 | 8 | 13 | S |
| R_{Gi} | Gate Input Resistance | | 3.5 | Ω |
| C_{iss} | } $V_{GS} = 0\text{V}$, $V_{DS} = 25\text{V}$, $f = 1\text{MHz}$ | | 1520 | pF |
| C_{oss} | | | 1100 | pF |
| C_{rss} | | | 1.8 | pF |
| Effective Output Capacitance | | | | |
| $C_{o(er)}$ | Energy related | } $V_{GS} = 0\text{V}$ $V_{DS} = 0.8 \cdot V_{DSS}$ | 72 | pF |
| $C_{o(tr)}$ | Time related | | 250 | pF |
| $t_{d(on)}$ | } Resistive Switching Times $V_{GS} = 10\text{V}$, $V_{DS} = 0.5 \cdot V_{DSS}$, $I_D = 0.5 \cdot I_{D25}$ $R_G = 10\Omega$ (External) | | 20 | ns |
| t_r | | | 30 | ns |
| $t_{d(off)}$ | | | 50 | ns |
| t_f | | | 26 | ns |
| $Q_{g(on)}$ | } $V_{GS} = 10\text{V}$, $V_{DS} = 0.5 \cdot V_{DSS}$, $I_D = 0.5 \cdot I_{D25}$ | | 29 | nC |
| Q_{gs} | | | 9 | nC |
| Q_{gd} | | | 11 | nC |
| R_{thJC} | | | | 0.43 $^\circ\text{C/W}$ |
| R_{thCS} | TO-220 | | 0.50 | $^\circ\text{C/W}$ |
| | TO-247 | | 0.21 | $^\circ\text{C/W}$ |

Source-Drain Diode

| Symbol | Test Conditions ($T_J = 25^\circ\text{C}$, Unless Otherwise Specified) | Characteristic Values | | |
|----------|---|-----------------------|------|-------|
| | | Min. | Typ. | Max |
| I_S | $V_{GS} = 0\text{V}$ | | | 18 A |
| I_{SM} | Repetitive, pulse Width Limited by T_{JM} | | | 72 A |
| V_{SD} | $I_F = I_S$, $V_{GS} = 0\text{V}$, Note 1 | | | 1.4 V |
| t_{rr} | } $I_F = 9\text{A}$, $-di/dt = 100\text{A}/\mu\text{s}$ $V_R = 100\text{V}$ | | 135 | ns |
| Q_{RM} | | | 840 | nC |
| I_{RM} | | | 12.5 | A |

Note 1. Pulse test, $t \leq 300\mu\text{s}$, duty cycle, $d \leq 2\%$.

IXYS Reserves the Right to Change Limits, Test Conditions, and Dimensions.

| | | | | | | | | | | |
|--|-----------|-----------|-----------|-----------|-------------|-------------|-------------|-------------|-------------|-------------|
| IXYS MOSFETs and IGBTs are covered by one or more of the following U.S. patents: | 4,835,592 | 4,931,844 | 5,049,961 | 5,237,481 | 6,162,665 | 6,404,065B1 | 6,683,344 | 6,727,585 | 7,005,734B2 | 7,157,338B2 |
| | 4,860,072 | 5,017,508 | 5,063,307 | 5,381,025 | 6,259,123B1 | 6,534,343 | 6,710,405B2 | 6,759,692 | 7,063,975B2 | |
| | 4,881,106 | 5,034,796 | 5,187,117 | 5,486,715 | 6,306,728B1 | 6,583,505 | 6,710,463 | 6,771,478B2 | 7,071,537 | |

Fig. 1. Output Characteristics @ $T_J = 25^\circ\text{C}$

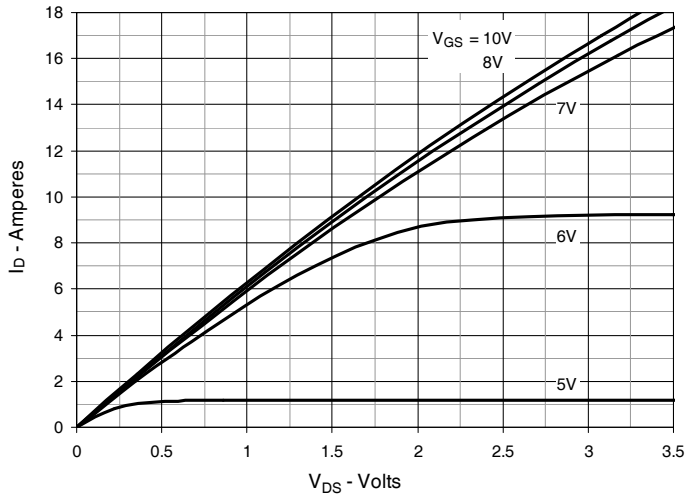

Fig. 2. Extended Output Characteristics @ $T_J = 25^\circ\text{C}$

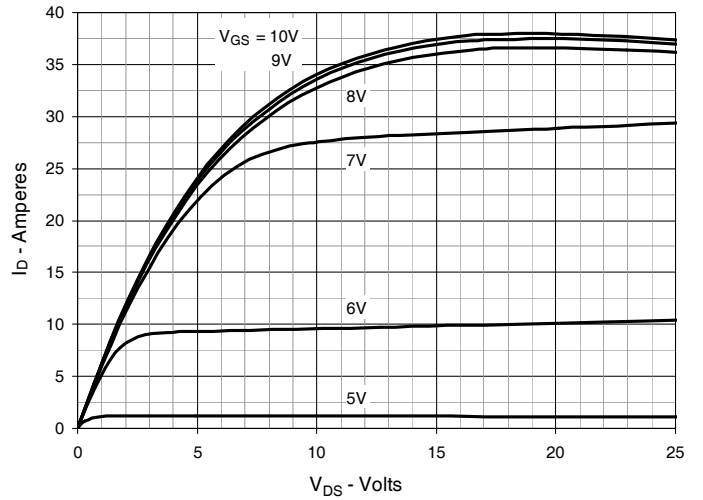

Fig. 3. Output Characteristics @ $T_J = 125^\circ\text{C}$

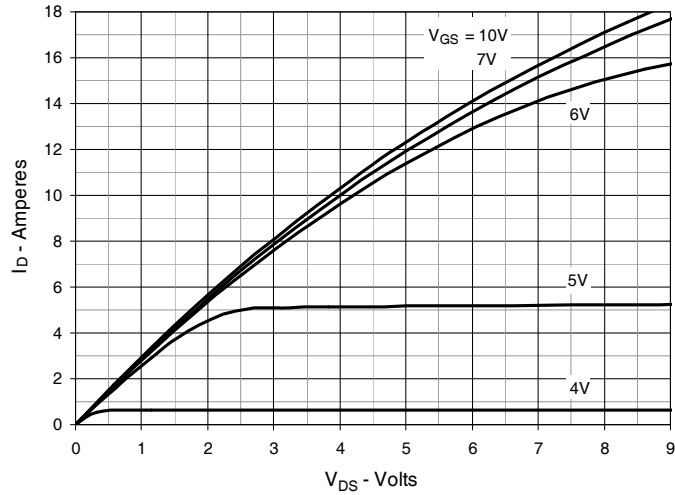

Fig. 4. $R_{DS(on)}$ Normalized to $I_D = 9\text{A}$ Value vs. Junction Temperature

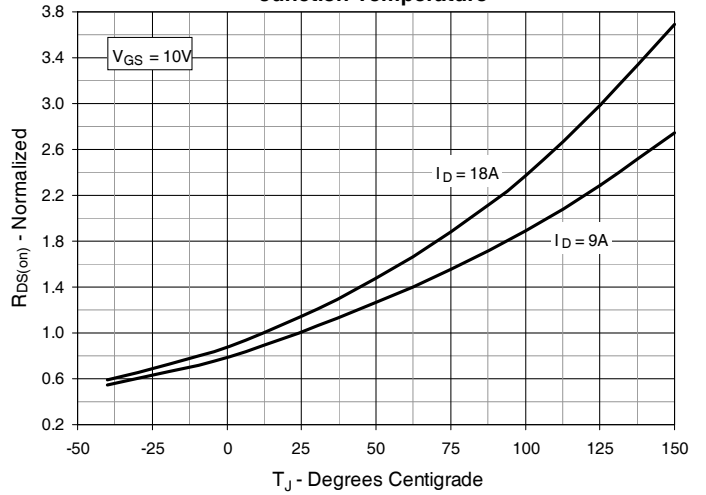

Fig. 5. $R_{DS(on)}$ Normalized to $I_D = 9\text{A}$ Value vs. Drain Current

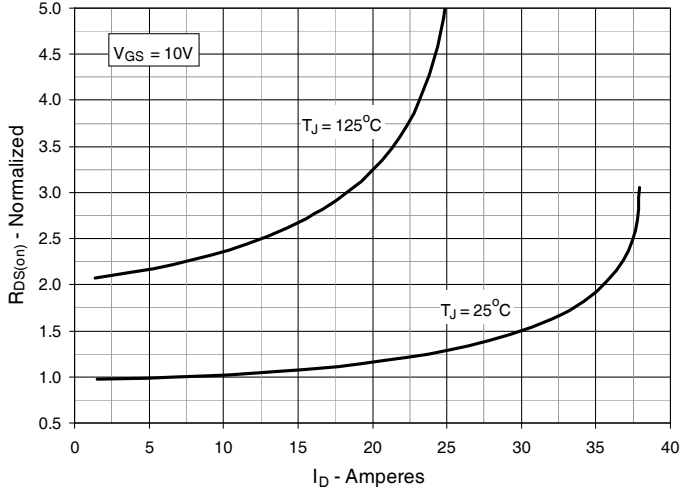

Fig. 6. Normalized Breakdown & Threshold Voltages vs. Junction Temperature

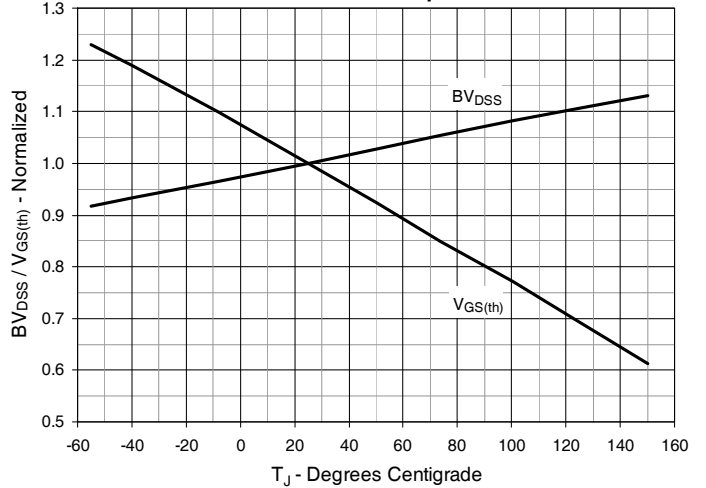

Fig. 7. Maximum Drain Current vs. Case Temperature

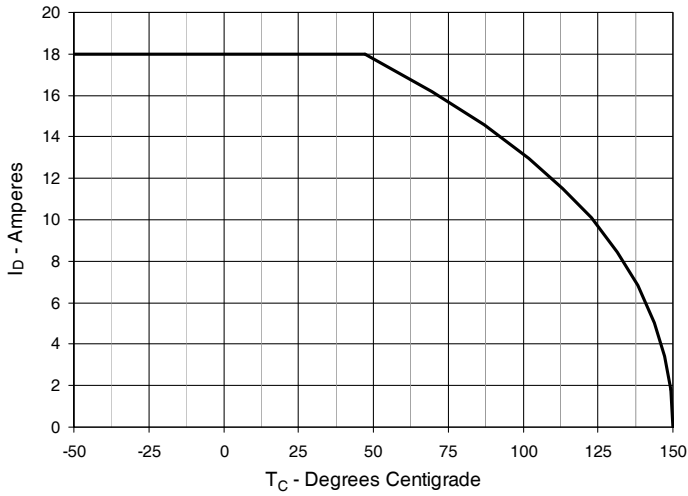

Fig. 8. Input Admittance

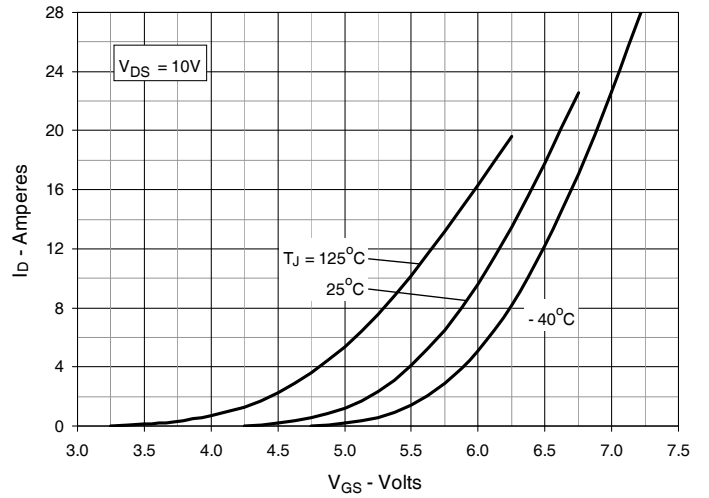

Fig. 9. Transconductance

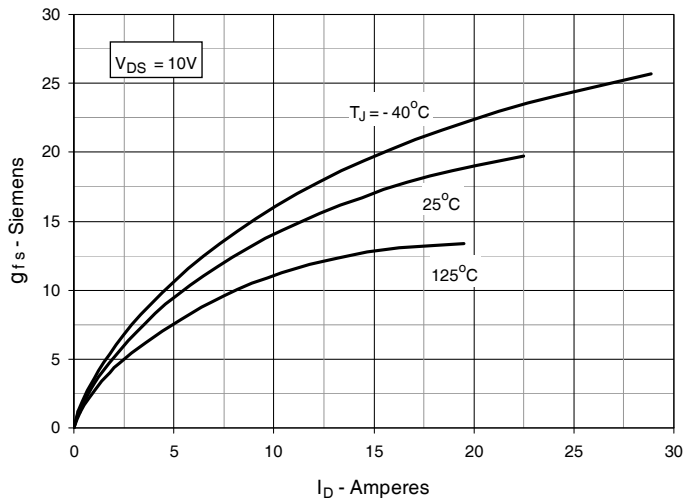

Fig. 10. Forward Voltage Drop of Intrinsic Diode

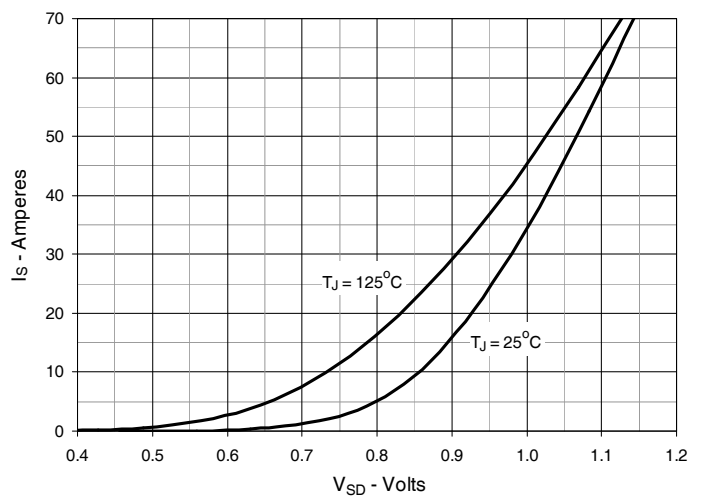

Fig. 11. Gate Charge

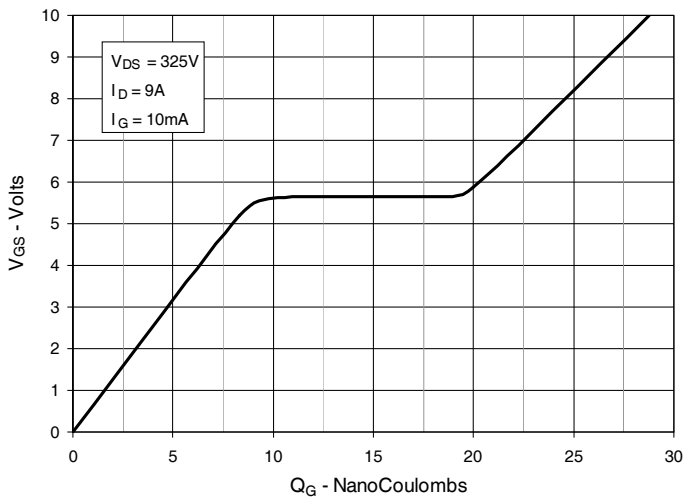

Fig. 12. Capacitance

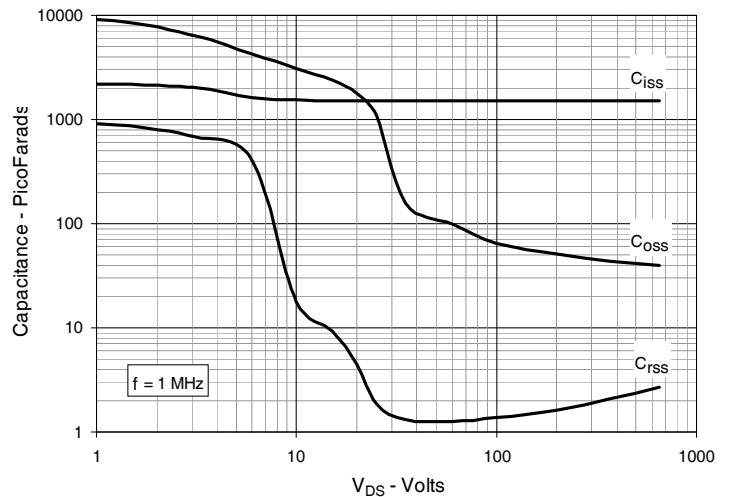

Fig. 13. Output Capacitance Stored Energy

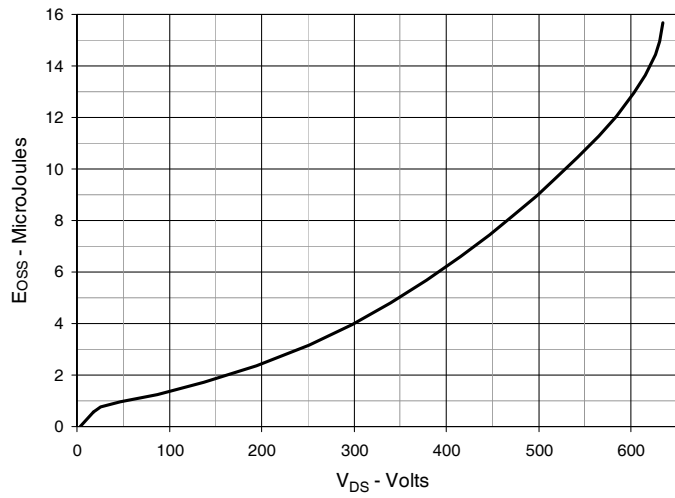

Fig. 14. Forward-Bias Safe Operating Area

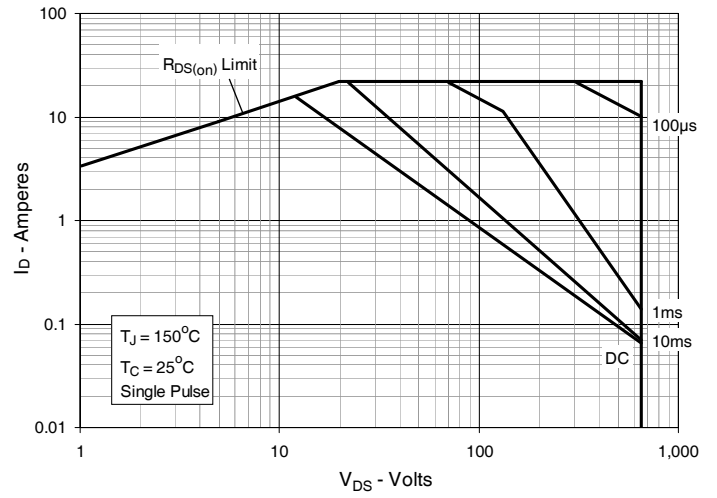
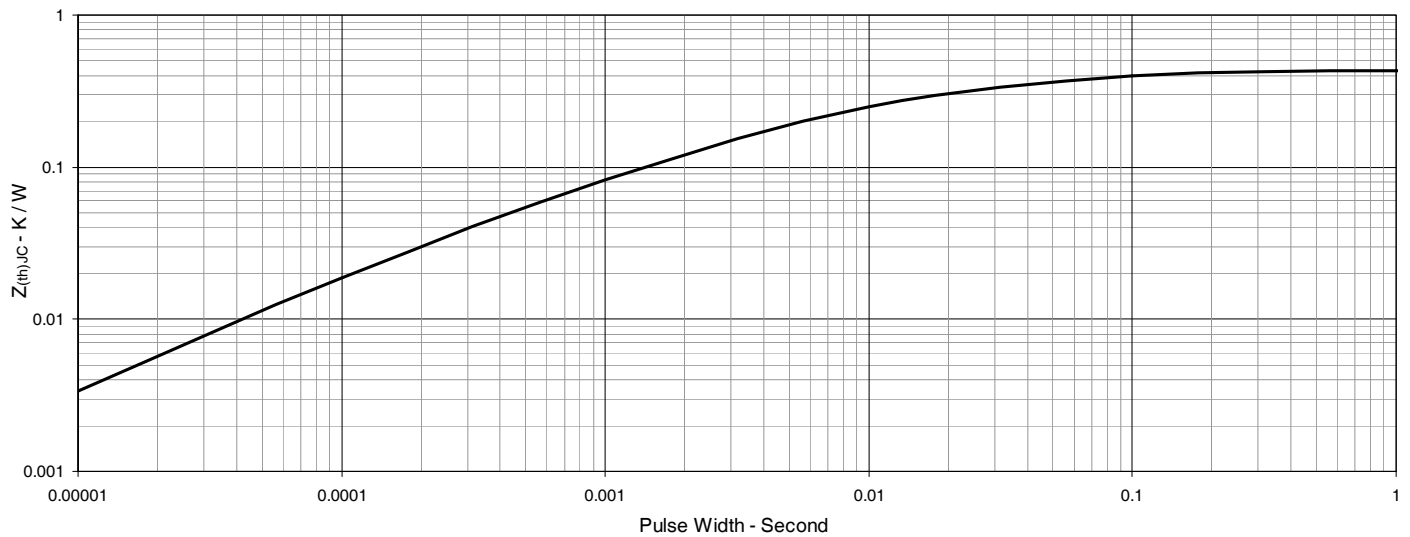
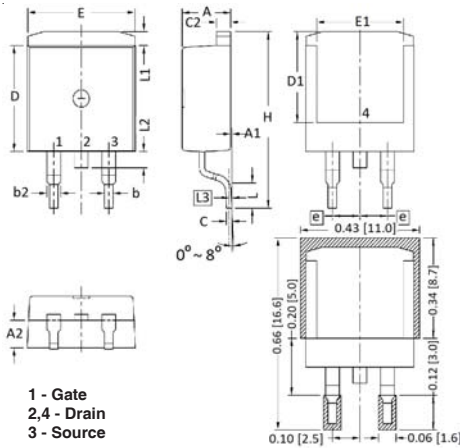

Fig. 15. Maximum Transient Thermal Impedance



TO-263 Outline



| SYM | INCHES | | MILLIMETER | |
|-----|----------|------|------------|-------|
| | MIN | MAX | MIN | MAX |
| A | .170 | .185 | 4.30 | 4.70 |
| A1 | .000 | .008 | 0.00 | 0.20 |
| A2 | .091 | .098 | 2.30 | 2.50 |
| b | .028 | .035 | 0.70 | 0.90 |
| b2 | .046 | .060 | 1.18 | 1.52 |
| C | .018 | .024 | 0.45 | 0.60 |
| C2 | .049 | .060 | 1.25 | 1.52 |
| D | .340 | .370 | 8.63 | 9.40 |
| D1 | .300 | .327 | 7.62 | 8.30 |
| E | .380 | .410 | 9.65 | 10.41 |
| E1 | .270 | .330 | 6.86 | 8.38 |
| e | .100 BSC | | 2.54 BSC | |
| H | .580 | .620 | 14.73 | 15.75 |
| L | .075 | .105 | 1.91 | 2.67 |
| L1 | .039 | .060 | 1.00 | 1.52 |
| L2 | — | .070 | — | 1.77 |
| L3 | .010 BSC | | 0.254 BSC | |

TO-220 Outline

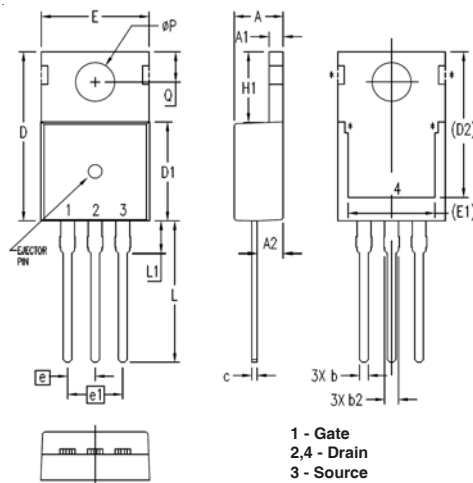

| SYM | INCHES | | MILLIMETERS | |
|------|----------|------|-------------|-------|
| | MIN | MAX | MIN | MAX |
| A | .169 | .185 | 4.30 | 4.70 |
| A1 | .047 | .055 | 1.20 | 1.40 |
| A2 | .079 | .106 | 2.00 | 2.70 |
| b | .024 | .039 | 0.60 | 1.00 |
| b2 | .045 | .057 | 1.15 | 1.45 |
| c | .014 | .026 | 0.35 | 0.65 |
| D | .587 | .626 | 14.90 | 15.90 |
| D1 | .335 | .370 | 8.50 | 9.40 |
| (D2) | .500 | .531 | 12.70 | 13.50 |
| E | .382 | .406 | 9.70 | 10.30 |
| (E1) | .283 | .323 | 7.20 | 8.20 |
| e | .100 BSC | | 2.54 BSC | |
| e1 | .200 BSC | | 5.08 BSC | |
| H1 | .244 | .268 | 6.20 | 6.80 |
| L | .492 | .547 | 12.50 | 13.90 |
| L1 | .110 | .154 | 2.80 | 3.90 |
| ∅P | .134 | .150 | 3.40 | 3.80 |
| Q | .106 | .126 | 2.70 | 3.20 |

TO-247 Outline

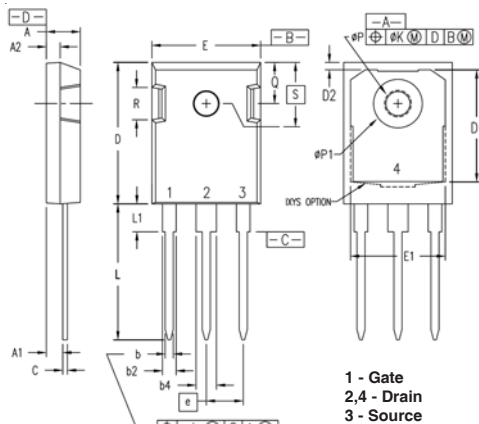

| SYM | INCHES | | MILLIMETERS | |
|-----|----------|------|-------------|-------|
| | MIN | MAX | MIN | MAX |
| A | .190 | .205 | 4.83 | 5.21 |
| A1 | .090 | .100 | 2.29 | 2.54 |
| A2 | .075 | .085 | 1.91 | 2.16 |
| b | .045 | .055 | 1.14 | 1.40 |
| b2 | .075 | .087 | 1.91 | 2.20 |
| b4 | .115 | .126 | 2.92 | 3.20 |
| C | .024 | .031 | 0.61 | 0.80 |
| D | .819 | .840 | 20.80 | 21.34 |
| D1 | .650 | .690 | 16.51 | 17.53 |
| D2 | .035 | .050 | 0.89 | 1.27 |
| E | .620 | .635 | 15.75 | 16.13 |
| E1 | .545 | .565 | 13.84 | 14.35 |
| e | .215 BSC | | 5.45 BSC | |
| J | -- | .010 | -- | 0.25 |
| K | -- | .025 | -- | 0.64 |
| L | .780 | .810 | 19.81 | 20.57 |
| L1 | .150 | .170 | 3.81 | 4.32 |
| ∅P | .140 | .144 | 3.55 | 3.65 |
| ∅P1 | .275 | .290 | 6.99 | 7.37 |
| Q | .220 | .244 | 5.59 | 6.20 |
| R | .170 | .190 | 4.32 | 4.83 |
| S | .242 BSC | | 6.15 BSC | |



Disclaimer Notice - Information furnished is believed to be accurate and reliable. However, users should independently evaluate the suitability of and test each product selected for their own applications. Littelfuse products are not designed for, and may not be used in, all applications. Read complete Disclaimer Notice at www.littelfuse.com/disclaimer-electronics.