

### DHB34 Varistor Series



#### Agency Approvals

Agency	Agency Approval	Agency File Number
	UL1449	E320116

#### Additional Information



Datasheet



Resources



Samples

#### Description

The DHB34 Series of transient surge suppressors is comprised of two industrial high-energy Metal-Oxide Varistors (MOVs) discs placed in parallel as a single device. They are designed to provide surge suppression in the AC mains outdoor and service entrance environment (distribution panels) of buildings. DHB34 applications also include industrial heavy motors, controls, and power supplies such as used in the oil-drilling, mining, and transportation fields, including HVAC and motor/generator applications.

The DHB34 Series provides rigid terminals for through-hole solder mounting on printed circuit boards, thereby eliminating the need for screw mounting.

#### Features

- Lead-Free, Halogen-Free and RoHS Compliant
- Wide operating voltage range  
 $V_{M(AC)RMS}$  110V to 750V
- High-energy absorption capability  
 $W_{TM} = 220J$  to 1050J
- High peak pulse current (Each of two discs placed in parallel) capability  
 $I_{TM} = 40,000A$
- Rigid terminals for secure through-hole solder mounting
- No derating up to 85°C ambient
- Dual Disc Device - two 34mm varistor discs in parallel in a single package.

#### Absolute Maximum Ratings

• For ratings of individual members of a series, see Device Ratings and Specifications chart

Continuous		DHB34 Series	Units
Steady State Applied Voltage:			
AC Voltage Range ( $V_{M(AC)RMS}$ )		110 to 750	V
DC Voltage Range ( $V_{M(DC)}$ )		148 to 970	V
Transients:			
Peak Pulse Current ( $I_{TM}$ )			
For 8/20 $\mu$ s Current Wave (See Figure 2)		40000	A
Single Pulse Energy Range			
For 2ms Current Wave ( $W_{TM}$ )		220 to 1050	J
Operating Ambient Temperature Range ( $T_A$ )		-55 to + 85	°C
Storage Temperature Range ( $T_{STG}$ )		-55 to + 125	°C
Temperature Coefficient ( $\alpha^V$ ) of Clamping Voltage ( $V_C$ ) at Specified Test Current		<0.01	%/°C
Hi-Pot Encapsulation (COATING Isolation Voltage Capability)		2500	V
COATING Insulation Resistance		1000	M $\Omega$

**CAUTION:** Stresses above those listed in "Absolute Maximum Ratings" may cause permanent damage to the device. This is a stress only rating and operation of the device at these or any other conditions above those indicated in the operational sections of this specification is not implied.

### DHB34 Series Ratings & Specifications

Lead-free and RoHS Compliant Models	Model Size Disc Dia. (mm)	Maximum Rating (85°C)				Specifications (25°C)				
		Continuous		Transient		Varistor Voltage at 1mA DC Test Current			Maximum Clamping Voltage $V_c$ at 200A Current (8/20 $\mu$ s)	Typical Capacitance
		$V_{RMS}$	$V_{DC}$	Energy (2ms)	Peak Current 8 x 20 $\mu$ s					
		$V_{M(AC)}$	$V_{M(DC)}$	$W_{TM}$	$I_{TM}$	Min	$V_{N(DC)}$	Max	$V_c$	f = 1MHz
Part Number		(V)	(V)	(J)	(A)	(V)	(V)	(V)	(V)	(pF)
V111DHB34	34	110	148	220	40,000 <sup>1</sup>	156	173	190	288	11,600
V131DHB34	34	130	175	270	40,000 <sup>2</sup>	184.5	205	225.5	345	10,000
V141DHB34	34	140	188	291	40,000 <sup>3</sup>	198	220	242	375	9,000
V151DHB34	34	150	200	300	40,000 <sup>4</sup>	216	240	264	405	8,000
V181DHB34	34	180	240	330	40,000	254	282	310	468	6,800
V201DHB34	34	200	265	350	40,000	283	314	345	533	6,350
V251DHB34	34	250	330	370	40,000	351	390	429	650	5,000
V271DHB34	34	275	369	400	40,000	387	430	473	730	4,500
V301DHB34	34	300	410	430	40,000	423	470	517	780	4,100
V321DHB34	34	320	420	460	40,000	459	510	561	830	3,800
V331DHB34	34	330	435	475	40,000	467	518.5	570	843	3,750
V351DHB34	34	350	460	500	40,000	495	549.5	604	894	3,600
V391DHB34	34	385	510	550	40,000	545	604	663	1,000	3,500
V421DHB34	34	420	560	600	40,000	612	680	748	1,130	3,000
V441DHB34	34	440	585	630	40,000	622	690	758	1,147	2,900
V481DHB34	34	480	640	650	40,000	675	750	825	1,240	2,700
V511DHB34	34	510	675	700	40,000	738	820	902	1,350	2,500
V551DHB34	34	550	710	755	40,000	778	863.5	949	1,404	2,390
V571DHB34	34	575	730	770	40,000	819	910	1001	1,480	2,200
V661DHB34	34	660	850	900	40,000	945	1050	1155	1,720	2,000
V681DHB34	34	680	875	925	40,000	962	1067.5	1173	1,777	1,900
V751DHB34	34	750	970	1050	40,000	1080	1200	1320	2,000	1,800

**Note:**

1. 40kA capability depends on applications rated up to 97V<sub>RMS</sub>. 30kA applies if > 97 V<sub>RMS</sub>.
2. 40kA capability depends on applications rated up to 115V<sub>RMS</sub>. 30kA applies if > 115 V<sub>RMS</sub>.
3. 40kA capability depends on applications rated up to 123V<sub>RMS</sub>. 30kA applies if > 123 V<sub>RMS</sub>.
4. 40kA capability depends on applications rated up to 132V<sub>RMS</sub>. 30kA applies if > 132 V<sub>RMS</sub>.

### Power Dissipation Ratings

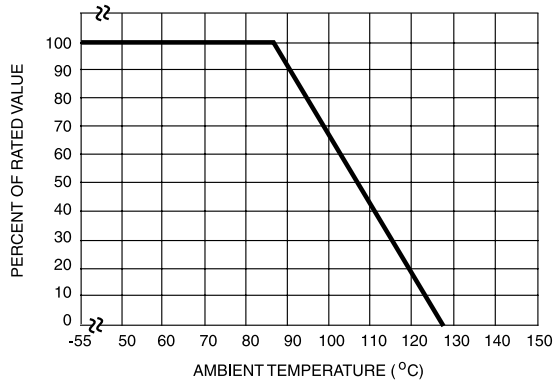

Figure 1

Should transients occur in rapid succession, the average power 100 dissipation result is simply the energy (watt-seconds) per pulse times the number of pulses per second. The power so developed must be within the specifications shown on the Device Ratings and Specifications table for the specific device. The operating values must be derated as shown in above.

### Peak Pulse Current Test Waveform

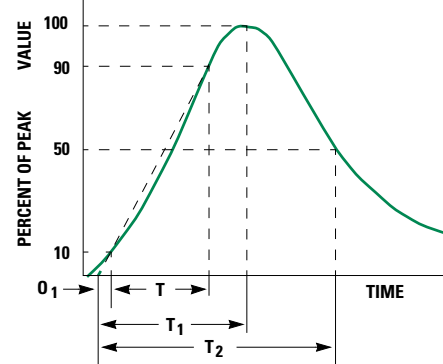

Figure 2

$O_1$  = Virtual Origin of Wave  
 $T$  = Time from 10% to 90% of Peak  
 $T_1$  = Rise Time =  $1.25 \times T$   
 $T_2$  = Decay Time  
**Example** - For an  $8/20 \mu s$  Current Waveform:  
 $8 \mu s = T_1$  = Rise Time  
 $20 \mu s = T_2$  = Decay Time

### Maximum Clamping Voltage

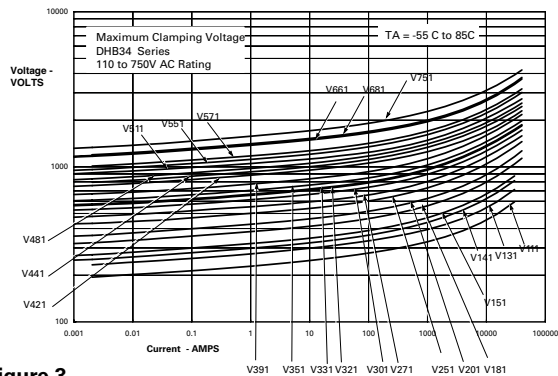

Figure 3

### Repetitive Surge Capability

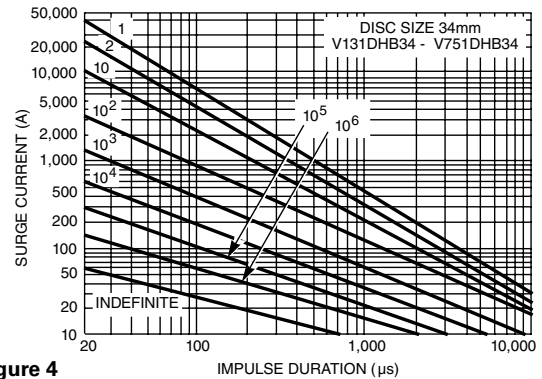

Figure 4

**NOTE:** If pulse ratings are exceeded, a shift of  $V_{NDC}$  (at specified current) of more than +/-10% could result. This type of shift, which normally results in a decrease of  $V_{NDC}$ , may result in the device not meeting the original published specifications, but it does not prevent the device from continuing to function, and to provide ample protection.

### Soldering Parameters

#### Non Lead-free Profile

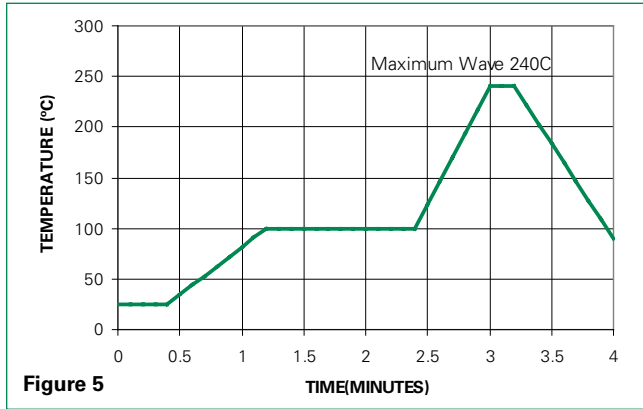

Figure 5

#### Lead-free Profile

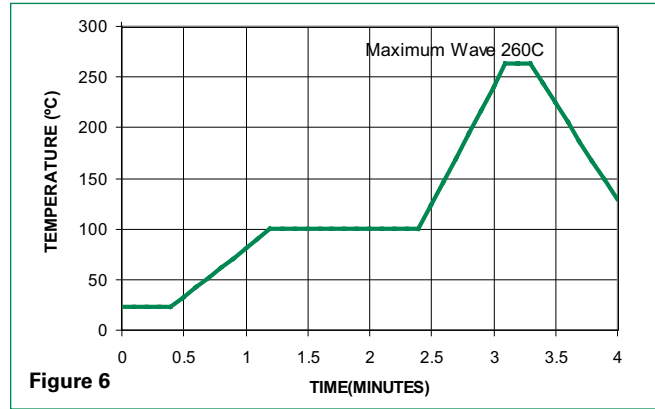

Figure 6

<b>Reflow Condition</b>		Pb – Free assembly
<b>Pre Heat</b>	- Temperature Min (Ts(min))	150°C
	- Temperature Max (Ts(max))	200°C
	- Time (min to max) (ts)	60 – 180 secs
<b>Average ramp up-rate (Liquidus Temp (TL) to peak TS(max) to TL - Ramp-up Rate</b>		5°C/second max
<b>Reflow</b>		
	- Temperature (TL) (Liquidus)	217°C
	- Temperature (tL)	60 – 150 seconds
<b>Peak Temperature (TP)</b>		250 <sup>+0/-5</sup> °C
<b>Time within 5°C of actual peak Temperature (tp)</b>		20 – 40 seconds
<b>Ramp-down Rate</b>		5°C/second max
<b>Time 25°C to peak Temperature (TP)</b>		8 minutes Max.
<b>Do not exceed</b>		260°C

#### Physical Specifications

<b>Lead Material</b>	Tin-coated Copper
<b>Soldering Characteristics</b>	Solderability per MIL-STD-202, Method 208
<b>Insulating Material</b>	Cured, flame retardant epoxy polymer meets UL94V-0 requirements.
<b>Device Labeling</b>	Marked with LF, voltage, amperage rating, and date code.

#### Environmental Specifications

<b>Operating/Storage Temperature</b>	-55°C to +85°C/-55°C to +125°C
<b>Humidity Aging</b>	+85°C, 85% RH, 1000 hours, +/-10% Voltage change
<b>Thermal Shock</b>	+85°C to -40°C 5 times, +/-10% Voltage change
<b>Solvent Resistance</b>	MIL-STD-202, Method 215
<b>Moisture Sensitivity</b>	Level 1, J-STD-020

### Dimensions (mm)

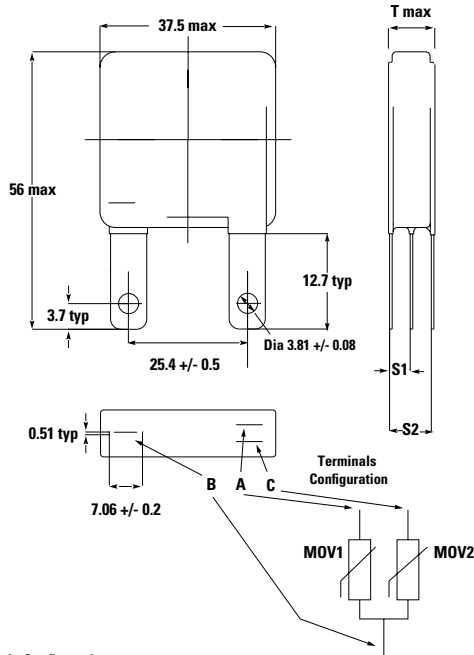

**NOTES:**

- **Terminals Configuration:**  
Terminals A & B are connected to one varistor element.  
Terminals B & C connected to second varistor element.
- **Dimensions:**  
Measures are in mm is typical, unless otherwise specified.

### Table of Dimensions - Thickness and Terminal Offsets

Part Type	T Max	S1 +/- 1.15 mm	S2 +/- 2.30mm
V111DHB34	7.6	2.65	5.50
V131DHB34	7.8	2.85	5.70
V141DHB34	8.2	3.00	6.00
V151DHB34	8.8	3.15	6.30
V181DHB34	9.0	3.25	6.50
V201DHB34	9.2	3.35	6.70
V251DHB34	9.10	3.00	6.00
V271DHB34	9.55	3.25	6.50
V301DHB34	10.20	3.50	7.00
V321DHB34	10.60	3.66	7.24
V331DHB34	10.65	3.70	7.40
V351DHB34	10.5	4.10	8.20
V391DHB34	11.2	4.45	8.90
V421DHB34	12.65	4.50	9.00
V441DHB34	12.80	4.55	9.10
V481DHB34	13.55	4.80	9.60
V511DHB34	13.4	5.25	10.50
V551DHB34	14.6	5.70	11.40
V571DHB34	14.8	5.80	11.60
V661DHB34	17.20	6.65	13.30
V681DHB34	17.5	7.00	14.00
V751DHB34	18.20	7.35	14.70

### Part Numbering System

