

### MLA Automotive Varistor Series



#### Size Table

Metric	EIA
1608	0603
2012	0805
3216	1206
3225	1210

#### Absolute Maximum Ratings

• For ratings of individual members of a series, see device ratings and specifications table.

Continuous	MLA Auto Series	Units
<b>Steady State Applied Voltage:</b>		
DC Voltage Range ( $V_{MDC}$ )	3.5 to 120	V
AC Voltage Range ( $V_{MIACIRMS}$ )	2.5 to 107	V
<b>Transient:</b>		
Non-Repetitive Surge Current, 8/20 $\mu$ s Waveform, ( $I_{TM}$ )	up to 500	A
Non-Repetitive Surge Energy, 10/1000 $\mu$ s Waveform, ( $W_{TM}$ )	0.1 to 2.5	J
Operating Ambient Temperature Range ( $T_A$ )	-40 to +125	$^{\circ}$ C
Storage Temperature Range ( $T_{STG}$ )	-40 to +150	$^{\circ}$ C
Temperature Coefficient (V) of Clamping Voltage ( $V_C$ ) at Specified Test Current	<0.01	%/ $^{\circ}$ C

#### Additional Information



Datasheet



Resources



Samples

#### Description

The MLA Automotive Series of transient voltage surge suppression devices is based on the Littelfuse Multilayer fabrication technology. These components are designed to suppress a variety of transient events, including those specified in IEC 61000-4-2 or other standards used for Electromagnetic Compliance (EMC). The MLA Automotive Series is typically applied to protect integrated circuits and other components at the circuit board level.

The wide operating voltage and energy range make the MLA Automotive Series suitable for numerous applications on power supply, control and signal lines.

The MLA Automotive Series is manufactured from semiconducting ceramics, and is supplied in a leadless, surface mount package. The MLA Automotive Series is compatible with modern reflow and wave soldering procedures.

It can operate over a wider temperature range than Zener diodes, and has a much smaller footprint than plastic-housed components.

#### Features

- AEC-Q200 qualified
- Halogen-Free and RoHS compliant
- Leadless 0603, 0805, 1206 and 1210 chip sizes
- Multilayer ceramic construction technology
- -40 $^{\circ}$ C to +125 $^{\circ}$ C operating temp. range
- Operating voltage range  $V_{MDC} = 3.5V$  to 120V
- Rated for surge current (8 x 20 $\mu$ s)
- Rated for energy (10 x 1000 $\mu$ s)
- Inherent bi-directional clamping
- No plastic or epoxy packaging assures better than UL94V-0 flammability rating
- Standard low capacitance types available
- Load Dump energy rated per SAE Specification J1113

#### Applications

- Suppression of inductive switching or other transient events such as EFT and surge voltage at the circuit board level
- ESD protection for IEC 61000-4-2, MIL-STD-883c method 3015.7, and other industry specifications
- Provides on-board transient voltage protection for ICS and transistors
- Used to help achieve electromagnetic compliance of end products
- Replaces larger surface mount TVS Zeners in many applications

### Device Ratings and Specifications

Part Number	Maximum Ratings (125° C)							Specifications (25°C)		
	Maximum Continuous Working Voltage		Jump Start Voltage (5 min)	Load Dump Energy	Maximum Non-repetitive Surge Current (8/20µs)	Maximum Non-repetitive Surge Energy (10/1000µs)	Maximum Clamping Voltage at 1A (or as Noted) (8/20µs)	Nominal Voltage at 1mA DC Test Current		Typical Capacitance at f = 1MHz
	V <sub>M(DC)</sub>	V <sub>M(AC)</sub>	V <sub>JUMP</sub>	W <sub>LD</sub>	I <sub>TM</sub>	W <sub>TM</sub>	V <sub>C</sub>	V <sub>N(DC) Min</sub>	V <sub>N(DC) Max</sub>	C
(V)	(V)	(V)	(J)	(A)	(J)	(V)	(V)	(V)	(pF)	
V3.5MLA0603NHAUTO	3.5	2.5	--	--	30	0.100	13.0	3.7	7.0	860
V3.5MLA0805NHAUTO	3.5	2.5	--	--	120	0.300	13.0	3.7	7.0	1500
V3.5MLA0805LNHAUTO	3.5	2.5	--	--	40	0.100	13.0	3.7	7.0	1080
V3.5MLA1206NHAUTO	3.5	2.5	--	--	100	0.300	13.0	3.7	7.0	3000
V5.5MLA0603NHAUTO	5.5	4.0	--	--	30	0.100	17.5	7.1	9.3	830
V5.5MLA0805NHAUTO	5.5	4.0	--	--	120	0.300	17.5	7.1	9.3	1200
V5.5MLA0805LNHAUTO	5.5	4.0	--	--	40	0.100	17.5	7.1	9.3	400
V5.5MLA1206NHAUTO	5.5	4.0	--	--	150	0.400	17.5	7.1	9.3	2900
V9MLA0603NHAUTO	9.0	6.5	--	--	30	0.100	25.5	11.0	16.0	210
V9MLA0805LNHAUTO	9.0	6.5	--	--	40	0.100	25.5	11.0	16.0	400
V12MLA0805LNHAUTO	12.0	9.0	--	--	40	0.100	29.0	14.0	18.5	210
V14MLA0603NHAUTO	14.0	10.0	--	--	30	0.100	34.5	15.9	21.5	90
V14MLA0805NHAUTO	14.0	10.0	--	--	120	0.300	32.0	15.9	20.3	560
V14MLA0805LNHAUTO	14.0	10.0	--	--	40	0.100	32.0	15.9	20.3	320
V14MLA1206NHAUTO	14.0	10.0	--	--	150	0.400	32.0	15.9	20.3	800
V18MLA0603NHAUTO	18.0	14.0	24.5	0.3	30	0.100	50.0	22.0	28.0	120
V18MLA0805NHAUTO	18.0	14.0	24.5	1	120	0.300	44.0	22.0	28.0	245
V18MLA0805LNHAUTO	18.0	14.0	24.5	0.7	40	0.100	44.0	22.0	28.0	180
V18MLA1206NHAUTO	18.0	14.0	24.5	1.5	150	0.400	44.0	22.0	28.0	1050
V18MLA1210NHAUTO	18.0	14.0	24.5	3	500	2.500	44.0 at 2.5	22.0	28.0	2500
V26MLA0603NHAUTO	26.0	20.0	27.5	0.4	30	0.100	60.0	31.0	38.0	50
V26MLA0805NHAUTO	26.0	20.0	27.5	1	100	0.300	60.0	29.5	38.5	110
V26MLA0805LNHAUTO	26.0	20.0	27.5	0.7	40	0.100	60.0	29.5	38.5	90
V26MLA1206NHAUTO	26.0	20.0	27.5	1.5	150	0.600	60.0	29.5	38.5	600
V26MLA1210NHAUTO	26.0	20.0	27.5	3	300	1.200	60.0 at 2.5	29.5	38.5	1260
V30MLA0603NHAUTO	30.0	25.0	29	0.4	30	0.100	74.0	37.0	46.0	45
V30MLA0805LNHAUTO	30.0	25.0	29	0.7	30	0.100	72.0	37.0	46.0	80
V30MLA0805NHAUTO	30.0	25.0	29	1	80	0.300	72.0	37.0	46.0	100
V30MLA1210NHAUTO	30.0	25.0	29	3	280	1.200	68.0 at 2.5	35.0	43.0	690
V30MLA1210LNHAUTO	30.0	25.0	29	3	220	0.900	68.0 at 2.5	35.0	43.0	500
V33MLA1206NHAUTO	33.0	26.0	36	1.5	180	0.800	75.0	38.0	49.0	380
V42MLA1206NHAUTO	42.0	30.0	48	1.5	180	0.800	92.0	46.0	60.0	340
V48MLA1210NHAUTO	48.0	40.0	48	3	250	1.200	105.0 at 2.5	54.5	66.5	400
V48MLA1210LNHAUTO	48.0	40.0	-	-	220	0.90	105.0 at 2.5	54.5	66.5	320
V48MLA1206NHAUTO	48.0	40.0	48	1.5	180	0.90	100	54.5	66.5	180
V56MLA1206NHAUTO	56.0	40.0	48	1.5	180	1.00	120.0	61.0	77.0	150
V60MLA1210NHAUTO	60.0	50.0	48	3	250	1.50	130.0 at 2.5	67.0	83.0	230
V68MLA1206NHAUTO	68.0	50.0	48	1.5	180	1.00	140.0	76.0	90.0	130
V85MLA1210NHAUTO	85.0	67.0	48	3	150	2.50	180.0 at 2.5	95.0	115.0	160
V120MLA1210NHAUTO	120.0	107.0	48	3	125	2.00	260.0 at 2.5	135.0	165.0	80

#### NOTES:

- 'L' suffix is a low capacitance and energy version; Contact your Littelfuse sales representative for custom capacitance requirements
- Typical leakage at 25°C < 25µA, maximum leakage 100µA at V<sub>M(DC)</sub>
- Average power dissipation of transients for 0603, 0805, 1206 and 1210 sizes not to exceed 0.05W, 0.1W, 0.1W and 0.15W respectively
- Load dump :min. time of energy input 40ms, interval 60sec(the load dump time constant Td differs from the time constant of energy input; load dump rating for ISO 7637-2 pulse 5a and ISO16750-2 Table 5A. Please contact Littelfuse.

**Peak Current and Energy Derating Curve**

When transients occur in rapid succession, the average power dissipation is the energy (watt-seconds) per pulse times the number of pulses per second. The power so developed must be within the specifications shown on the Device Ratings and Specifications Table for the specific device. For applications exceeding 125°C ambient temperature, the peak surge current and energy ratings must be derated as shown below.

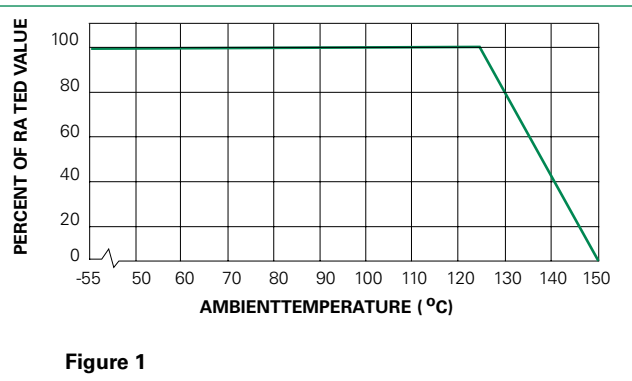

**Peak Pulse Current Test Waveform for Clamping Voltage**

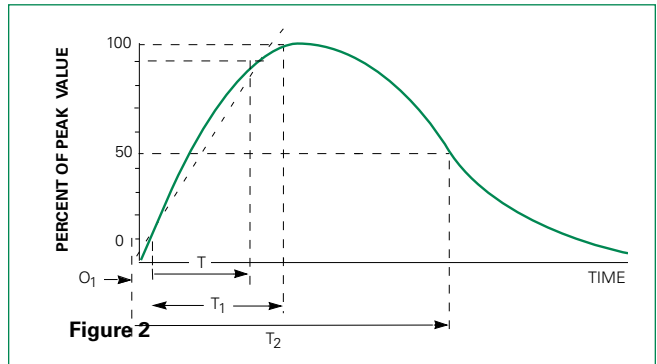

$O_1$  = Virtual Origin of Wave  
 $T$  = Time from 10% to 90% of Peak  
 $T_1$  = Rise Time =  $1.25 \times T$   
 $T_2$  = Decay Time  
**Example** - For an 8/20  $\mu s$  Current Waveform:  
 $8 \mu s = T_1$  = Rise Time  
 $20 \mu s = T_2$  = Decay Time

**Limit V-I Characteristic for V3.5MLA0603NHAUTO to V30MLA0603NHAUTO**

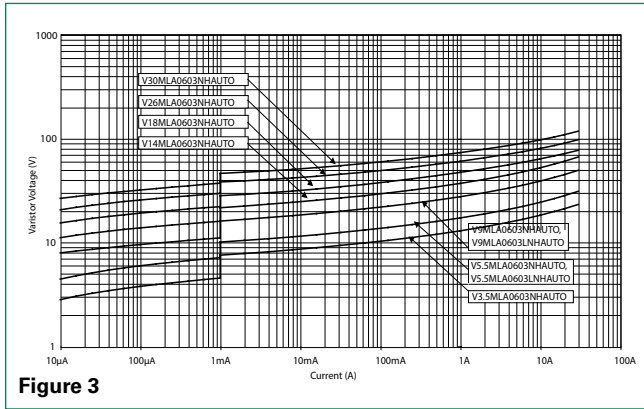

**Figure 3**

**Limit V-I Characteristic for V3.5MLA0805LNHAUTO to V30MLA0805LNHAUTO**

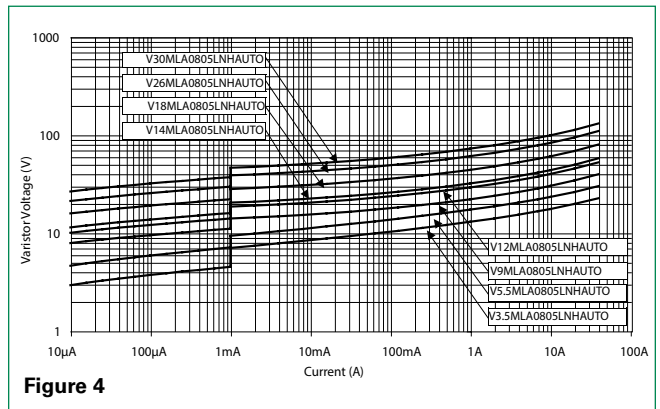

**Figure 4**

**Limit V-I Characteristic for V3.5MLA0805NHAUTO to V26MLA0805NHAUTO**

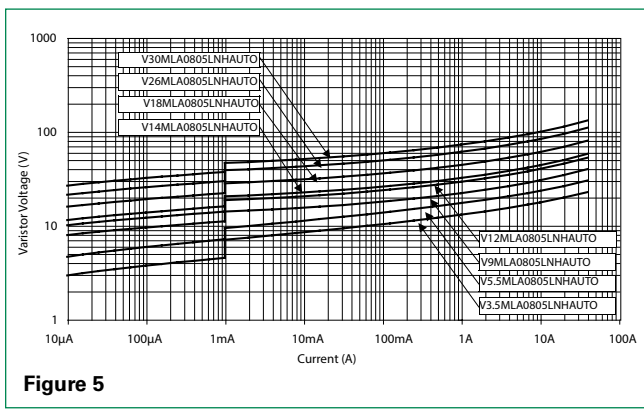

**Figure 5**

**Limit V-I Characteristic for V3.5MLA1206NHAUTO to V42MLA1206NHAUTO**

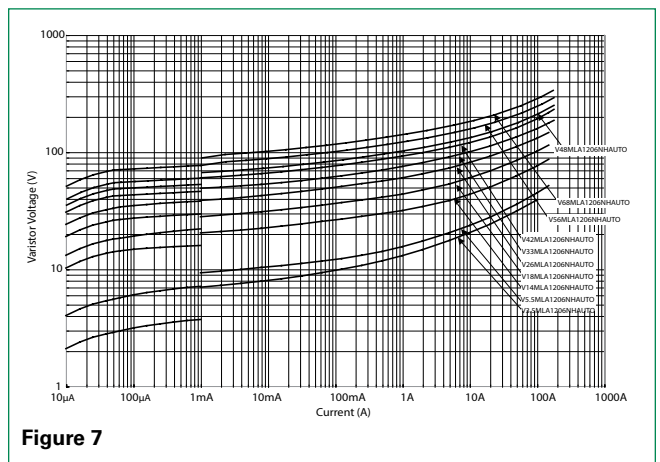

**Figure 7**

**Limit V-I Characteristic for V18MLA1210NHAUTO to V48MLA1210NHAUTO**

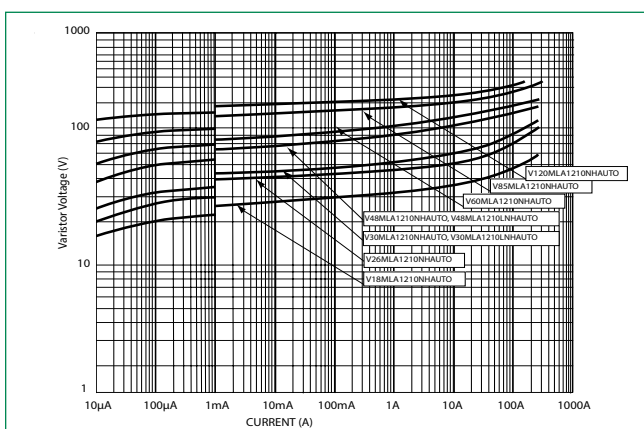

**Figure 6**

**Device Characteristics**

At low current levels, the V-I curve of the multilayer transient voltage suppressor approaches a linear (ohmic) relationship and shows a temperature dependent effect. At or below the maximum working voltage, the suppressor is in a high resistance modex (approaching  $10^6\Omega$  at its maximum rated working voltage). Leakage currents at maximum rated voltage are below  $100\mu A$ , typically  $25\mu A$ .

Typical Temperature Dependence of the Haracteristic Curve in the Leakage Region

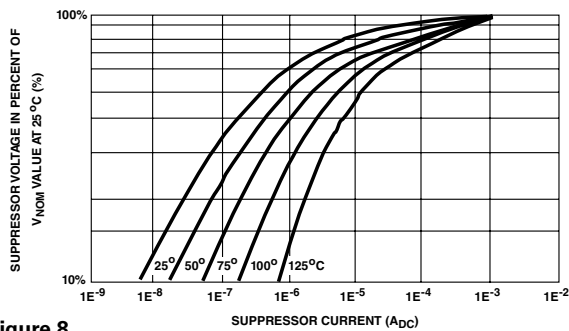

Figure 8

**Speed of Response**

The Multilayer Suppressor is a leadless device. Its response time is not limited by the parasitic lead inductances found in other surface mount packages. The response time of the  $Z_{n}O$  dielectric material is less than 1ns and the MLA Automotive Series can clamp very fast dV/dT events such as ESD. Additionally, in "real world" applications, the associated circuit wiring is often the greatest factor effecting speed of response. Therefore, transient suppressor placement within a circuit can be considered important in certain instances.

Multilayer Internal Construction

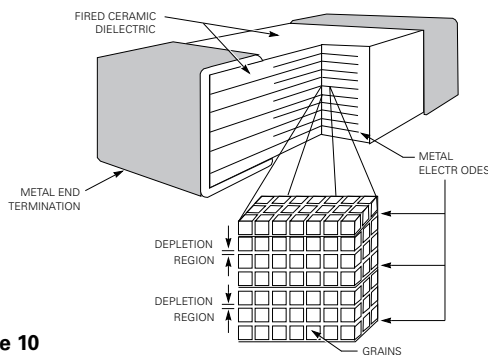

Figure 10

**Clamping Voltage Over Temperature ( $V_c$  at 10A)**

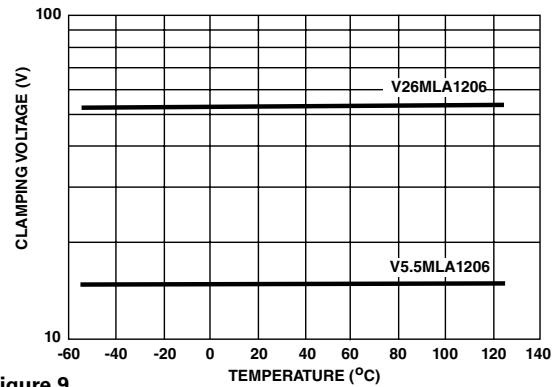

Figure 9

**Energy Absorption/Peak Current Capability**

Energy dissipated within the MLA Automotive Series is calculated by multiplying the clamping voltage, transient current and transient duration. An important advantage of the multilayer is its interdigitated electrode construction within the mass of dielectric material. This results in excellent current distribution and the peak temperature per energy absorbed is very low. The matrix of semiconducting grains combine to absorb and distribute transient energy (heat) (see Speed of Response). This dramatically reduces peak temperature; thermal stresses and enhances device reliability.

As a measure of the device capability in energy and peak current handling, the V26MLA1206 part was tested with multiple pulses at its peak current rating (150A, 8/20 $\mu s$ ). At the end of the test, 10,000 pulses later, the device voltage characteristics are still well within specification.

Repetitive Pulse Capability

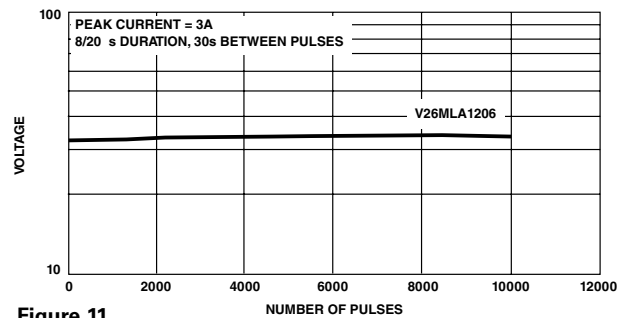

Figure 11

**Lead (Pb) Soldering Recommendations**

The principal techniques used for the soldering of components in surface mount technology are IR Re-flow and Wave soldering. Typical profiles are shown on the right.

The recommended solder for the MLA Automotive Series suppressor is a 62/36/2 (Sn/Pb/Ag), 60/40 (Sn/Pb) or 63/37 (Sn/Pb). Littelfuse also recommends an RMA solder flux.

Wave soldering is the most strenuous of the processes. To avoid the possibility of generating stresses due to thermal shock, a preheat stage in the soldering process is recommended, and the peak temperature of the solder process should be rigidly controlled.

When using a reflow process, care should be taken to ensure that the MLA Automotive Series chip is not subjected to a thermal gradient steeper than 4 degrees per second; the ideal gradient being 2 degrees per second. During the soldering process, preheating to within 100 degrees of the solder's peak temperature is essential to minimize thermal shock.

Once the soldering process has been completed, it is still necessary to ensure that any further thermal shocks are avoided. One possible cause of thermal shock is hot printed circuit boards being removed from the solder process and subjected to cleaning solvents at room temperature. The boards must be allowed to cool gradually to less than 50° C before cleaning.

**Reflow Solder Profile**

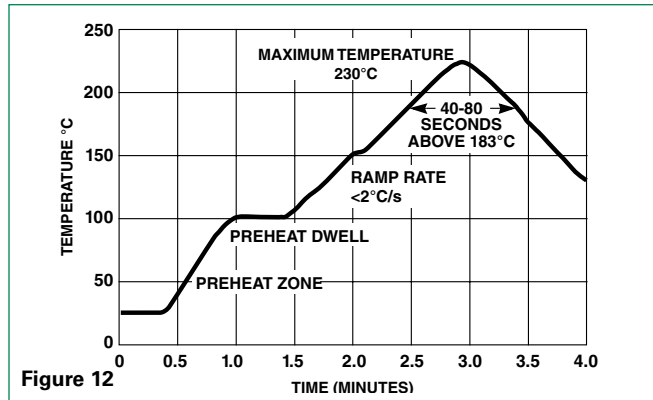

**Wave Solder Profile**

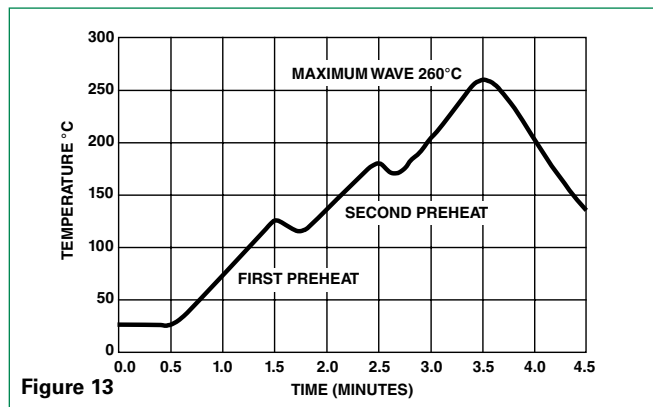

**Lead-free (Pb-free) Soldering Recommendations**

Littelfuse offers the Nickel Barrier Termination option (see "N" suffix in Part Numbering System for ordering) for the optimum Lead-free solder performance, consisting of a Matte Tin outer surface plated on Nickel underlayer, plated on Silver base metal.

The preferred solder is 96.5/3.0/0.5 (SnAgCu) with an RMA flux, but there is a wide selection of pastes and fluxes available with which the Nickel Barrier parts should be compatible.

The reflow profile must be constrained by the maximums in the Lead-free Reflow Profile. For Lead-free wave soldering, the Wave Solder Profile still applies.

Note: the Lead-free paste, flux and profile were used for evaluation purposes by Littelfuse, based upon industry standards and practices. There are multiple choices of all three available, it is advised that the customer explores the optimum combination for their process as processes vary considerably from site to site.

**Lead-free Re-flow Solder Profile**

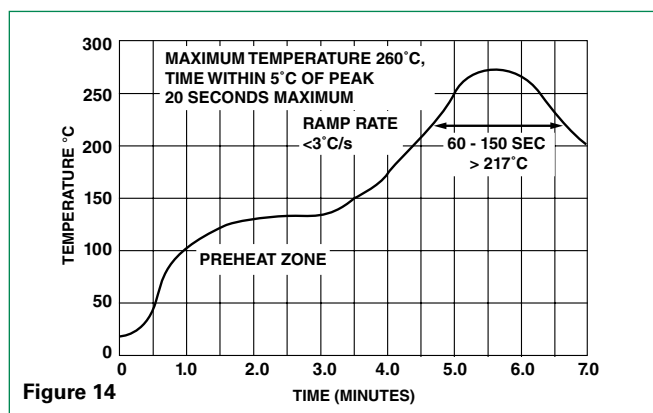

### Product Dimensions (mm)

PAD LAYOUT DIMENSIONS

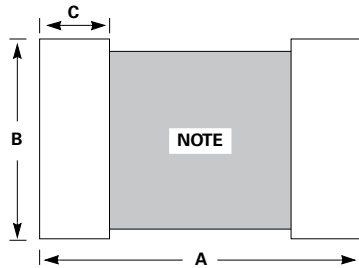

CHIP LAYOUT DIMENSIONS

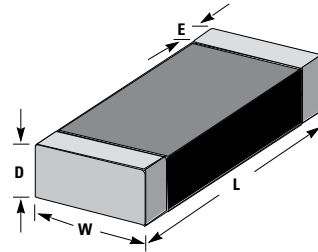

**NOTE** : Avoid metal runs in this area, parts not recommended for use in applications using Silver (Ag) epoxy paste.

Dimension	1210 Size		1206 Size		0805 Size		0603 Size	
	IN	MM	IN	MM	IN	MM	IN	MM
A	0.160	4.06	0.160	4.06	0.120	3.05	0.100	2.54
B	0.100	2.54	0.065	1.65	0.050	1.27	0.030	0.76
C	0.040	1.02	0.040	1.02	0.040	1.02	0.035	0.89
D (max.)	0.113	2.87	0.071	1.80	0.043	1.10	0.040	1.00
E	0.020 +/-0.010	0.50 +/-0.25	0.020 +/-0.010	0.50 +/-0.25	0.020 +/- 0.010	0.50 +/- 0.25	0.015 +/-0.008	0.4 +/-0.20
L	0.125 +/-0.012	3.20 +/-0.30	0.125 +/-0.012	3.20 +/-0.30	0.079 +/-0.008	2.01 +/-0.20	0.063 +/-0.006	1.6 +/-0.15
W	0.100 +/-0.012	2.54 +/-0.30	0.060 +/-0.011	1.60 +/-0.28	0.049 +/-0.008	1.25 +/-0.20	0.032 +/-0.060	0.8 +/-0.15

### Part Numbering System

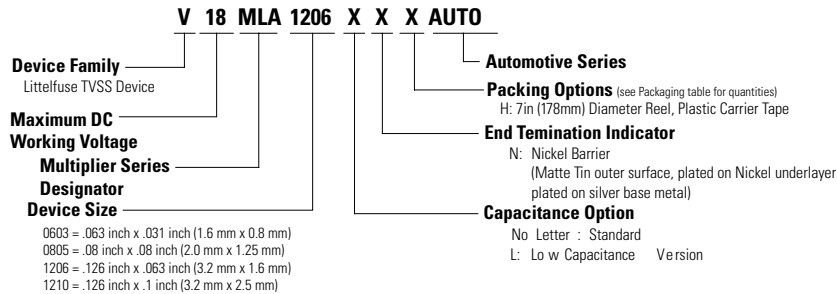

### Packaging\*

Device Size	Quantity
	7" Inch Reel ("H" Option)
1210	2,000
1206	2,500
0805	2,500
0603	2,500

\*(Packaging) It is recommended that parts be kept in the sealed bag provided and that parts be used as soon as possible when removed from bags.

### Tape and Reel Specifications

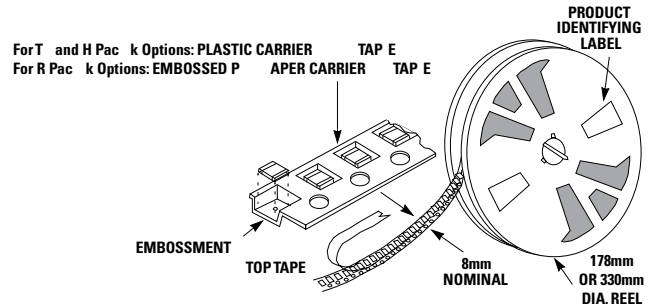
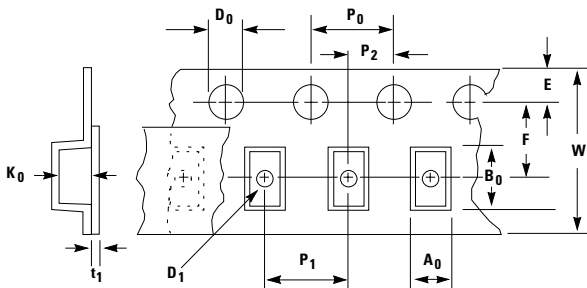

Symbol	Description	Dimensions in Millimeters
		0603, 0805, 1206 & 1210 Sizes
$A_0$	Width of Cavity	Dependent on Chip Size to Minimize Rotation.
$B_0$	Length of Cavity	Dependent on Chip Size to Minimize Rotation.
$K_0$	Depth of Cavity	Dependent on Chip Size to Minimize Rotation.
$W$	Width of Tape	8 $\pm$ 0.3
$F$	Distance Between Drive Hole Centers and Cavity Centers	3.5 $\pm$ 0.05
$E$	Distance Between Drive Hole Centers and Tape Edge	1.75 $\pm$ 0.1
$P_1$	Distance Between Cavity Centers	4 $\pm$ 0.1
$P_2$	Axial Drive Distance Between Drive Hole Centers & Cavity Centers	2 $\pm$ 0.1
$P_0$	Axial Drive Distance Between Drive Hole Centers	4 $\pm$ 0.1
$D_0$	Drive Hole Diameter	1.55 $\pm$ 0.05
$D_1$	Diameter of Cavity Piercing	1.05 $\pm$ 0.05
$T_1$	Top Tape Thickness	0.1 Max

**NOTES:**

- Conforms to EIA-481-1, Revision A
- Can be supplied to IEC publication 286-3