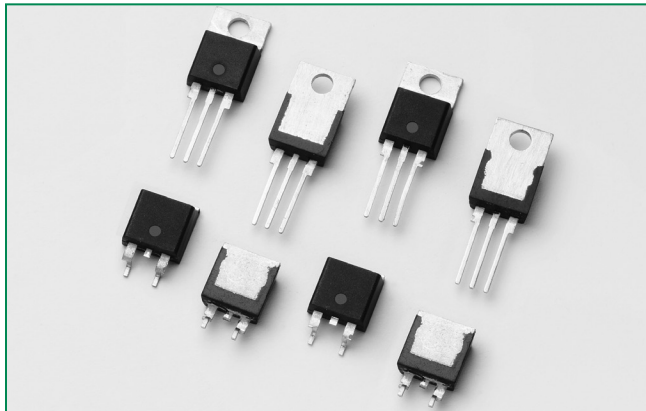


Sxx15x & Sxx16x Series



**Description**

The Sxx15x and Sxx16x Series provide excellent unidirectional switching for phase control applications such as heating and motor speed controls.

Standard phase control SCRs are triggered with few milliamperes of current at less than 1.5V potential.

**Features & Benefits**

- RoHS-compliant
- Glass – passivated junctions
- Voltage capability up to 1000 V
- Surge capability up to 225 A

**Agency Approval**

Agency	Agency File Number
	E71639*

\* - L Packages Only

**Applications**

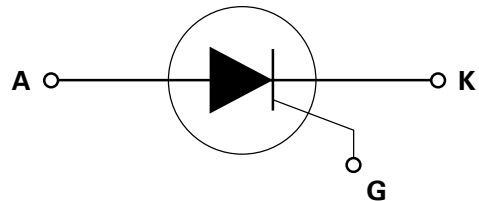
Typical applications are capacitive discharge systems for strobe lights, nailers, staplers and gas engine ignition. Also controls for power tools, home/brown goods and white goods appliances.

Internally constructed isolated packages are offered for ease of heat sinking with highest isolation voltage.

**Main Features**

Symbol	Value	Unit
$I_{T(RMS)}$	15 & 16	A
$V_{DRM}/V_{RRM}$	400 to 1000	V
$I_{GT}$	30	mA

**Schematic Symbol**



**Absolute Maximum Ratings – Standard SCRs**

Symbol	Parameter	Test Conditions		Value	Unit
		Model	Temp		
$I_{T(RMS)}$	RMS on-state current	Sxx15L	$T_c = 90^\circ\text{C}$	15	A
		Sxx16R Sxx16N	$T_c = 110^\circ\text{C}$	16	
$I_{T(AV)}$	Average on-state current	Sxx15L	$T_c = 90^\circ\text{C}$	9.5	A
		Sxx16R Sxx16N	$T_c = 110^\circ\text{C}$	10.0	
$I_{TSM}$	Peak non-repetitive surge current	single half cycle; $f = 50\text{Hz}$ ; $T_j(\text{initial}) = 25^\circ\text{C}$		188	A
		single half cycle; $f = 60\text{Hz}$ ; $T_j(\text{initial}) = 25^\circ\text{C}$		225	
$I^2t$	$I^2t$ Value for fusing	$t_p = 8.3 \text{ ms}$		210	$\text{A}^2\text{s}$
$di/dt$	Critical rate of rise of on-state current	$f = 60 \text{ Hz}; T_j = 125^\circ\text{C}$		125	$\text{A}/\mu\text{s}$
$I_{GM}$	Peak gate current	$T_j = 125^\circ\text{C}$		3	A
$P_{G(AV)}$	Average gate power dissipation	$T_j = 125^\circ\text{C}$		0.6	W
$T_{stg}$	Storage temperature range			-40 to 150	$^\circ\text{C}$
$T_j$	Operating junction temperature range			-40 to 125	$^\circ\text{C}$

Note: xx = voltage

### Electrical Characteristics (T<sub>J</sub> = 25°C, unless otherwise specified)

Symbol	Test Conditions			Value	Unit
				Sxx15x Sxx16x	
I <sub>GT</sub>	V <sub>D</sub> = 12V R <sub>L</sub> = 60 Ω	-	MAX.	30	mA
		-	MAX.	1	V
V <sub>GT</sub>	V <sub>D</sub> = 12V R <sub>L</sub> = 60 Ω	-	MAX.	1.5	V
dv/dt	V <sub>D</sub> = V <sub>DRM</sub> ; gate open; T <sub>J</sub> = 100°C	400V	MIN.	450	V/μs
		600V		425	
		800V		400	
	1000V	200			
	V <sub>D</sub> = V <sub>DRM</sub> ; gate open; T <sub>J</sub> = 125°C	400V		350	
		600V		325	
800V		300			
V <sub>GD</sub>	V <sub>D</sub> = V <sub>DRM</sub> R <sub>L</sub> = 3.3 kΩ T <sub>J</sub> = 110°C	-	MIN.	0.2	V
I <sub>H</sub>	I <sub>T</sub> = 200mA (initial)	-	MAX.	40	mA
t <sub>q</sub>	I <sub>T</sub> =2A; t <sub>p</sub> =50μs; dv/dt=5V/μs; di/dt=-30A/μs	-	MAX.	35	μs
t <sub>gt</sub>	I <sub>G</sub> = 2 x I <sub>GT</sub> PW = 15μs I <sub>T</sub> = 12A	-	TYP.	2	μs

**Note:** xx = voltage, x = package  
 (1) I<sub>T</sub>=2A; t<sub>p</sub>=50μs; dv/dt=5V/μs; di/dt=-30A/μs

### Static Characteristics

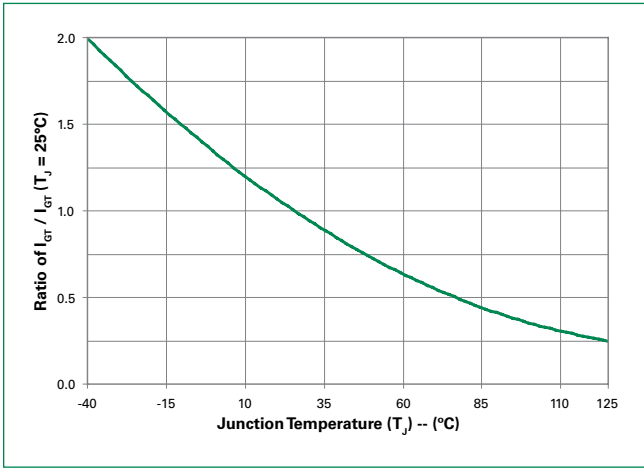
Symbol	Test Conditions		Value	Unit	
V <sub>TM</sub>	15A Device I <sub>T</sub> = 30A; t <sub>p</sub> = 380 μs		MAX.	1.6	V
	16A Device I <sub>T</sub> = 32A; t <sub>p</sub> = 380 μs				
I <sub>DRM</sub> / I <sub>RRM</sub>	V <sub>DRM</sub> = V <sub>RRM</sub>	T <sub>J</sub> = 25°C	400 - 600V	MAX.	10
			800 - 1000V		20
		T <sub>J</sub> = 100°C	400 - 600V		500
			800V		1000
			1000V		3000
		T <sub>J</sub> = 125°C	400 - 600V		1000
800V	2000				

### Thermal Resistances

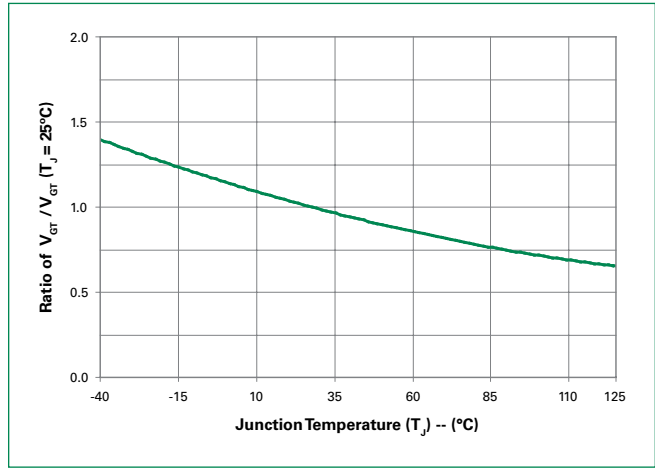
Symbol	Parameter	Value	Unit
R <sub>θ(J-C)</sub>	Junction to case (AC)	Sxx16R/ Sxx16N	1.1
		Sxx15L	2.5
R <sub>θ(J-A)</sub>	Junction to ambient	Sxx16R/Sxx16N	40
		Sxx15L	50

**Note:** xx = voltage

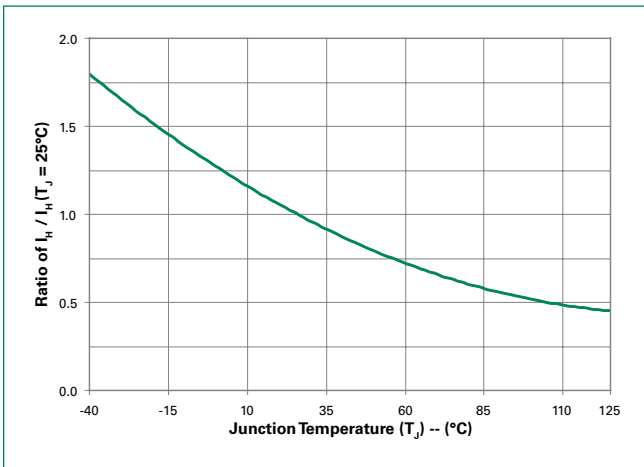
**Figure 1: Normalized DC Gate Trigger Current vs. Junction Temperature**



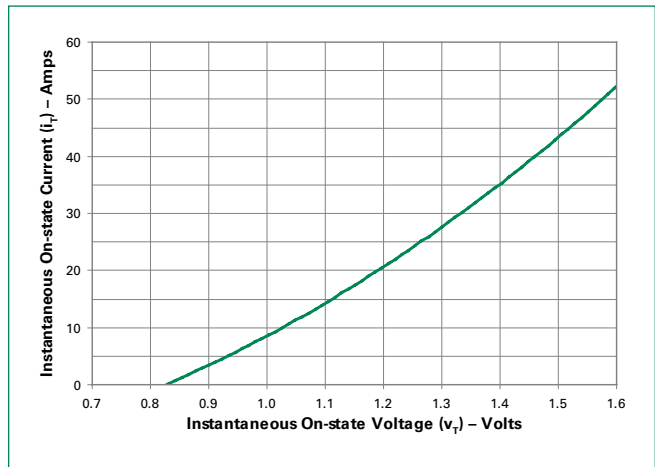
**Figure 2: Normalized DC Gate Trigger Voltage vs. Junction Temperature**



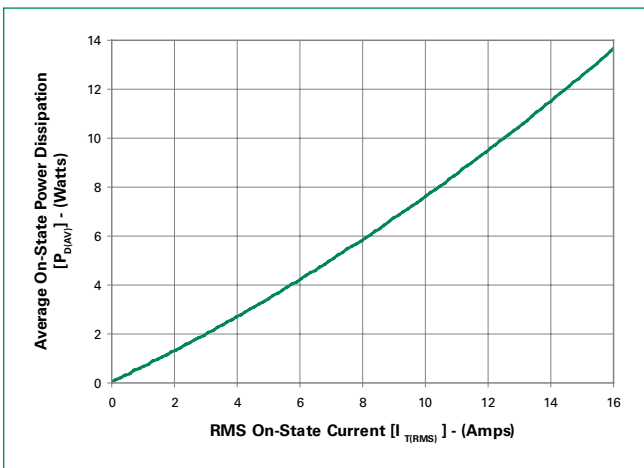
**Figure 3: Normalized DC Holding Current vs. Junction Temperature**



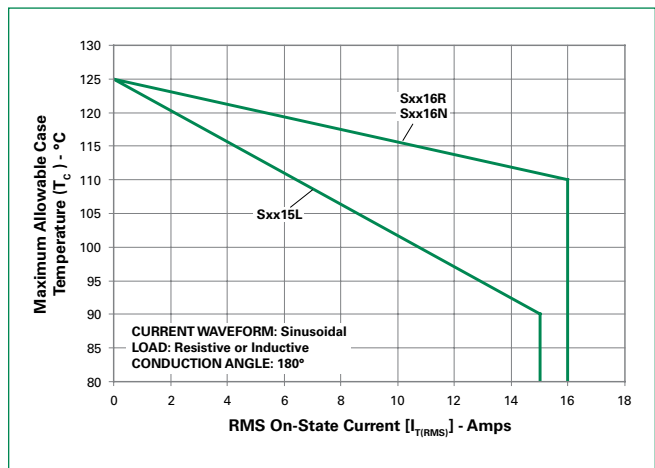
**Figure 4: On-State Current vs. On-State Voltage (Typical)**



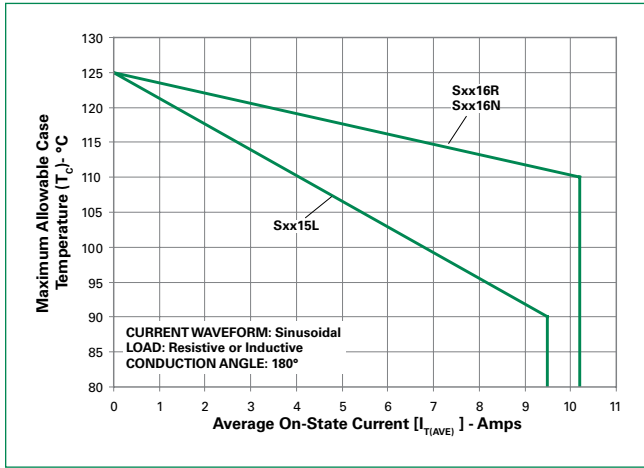
**Figure 5: Power Dissipation (Typical) vs. RMS On-State Current**



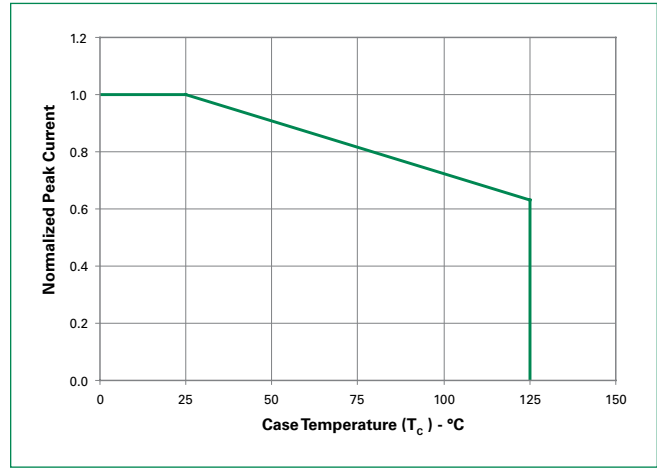
**Figure 6: Maximum Allowable Case Temperature vs. RMS On-State Current**



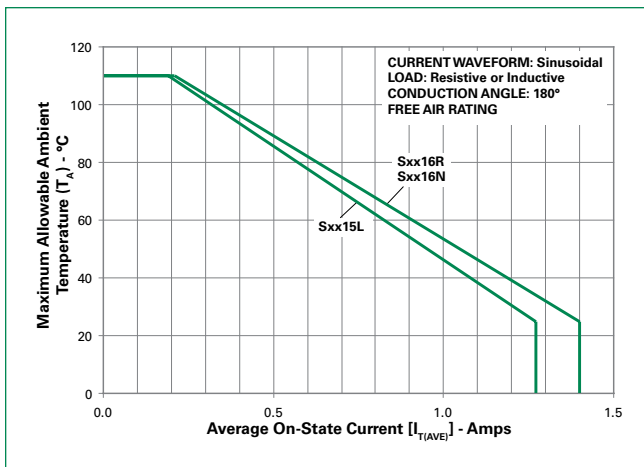
**Figure 7: Maximum Allowable Case Temperature vs. Average On-State Current**



**Figure 8: Maximum Allowable Ambient Temperature vs. RMS On-State Current**

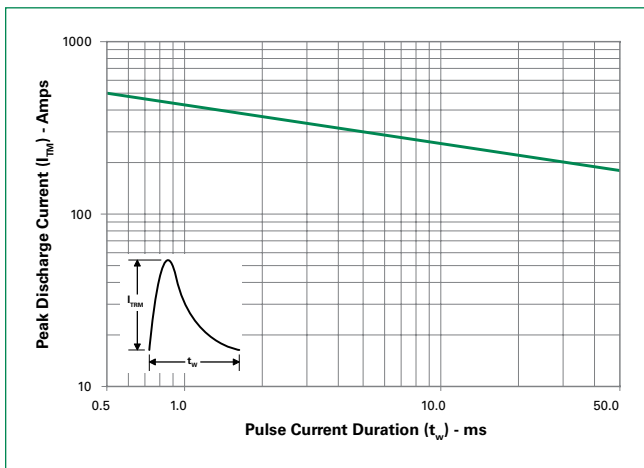


**Figure 9: Maximum Allowable Ambient Temperature vs. Average On-State Current**

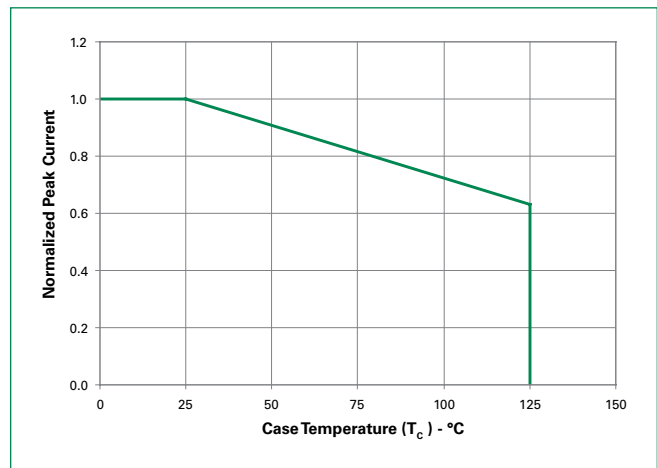


Note: xx = voltage

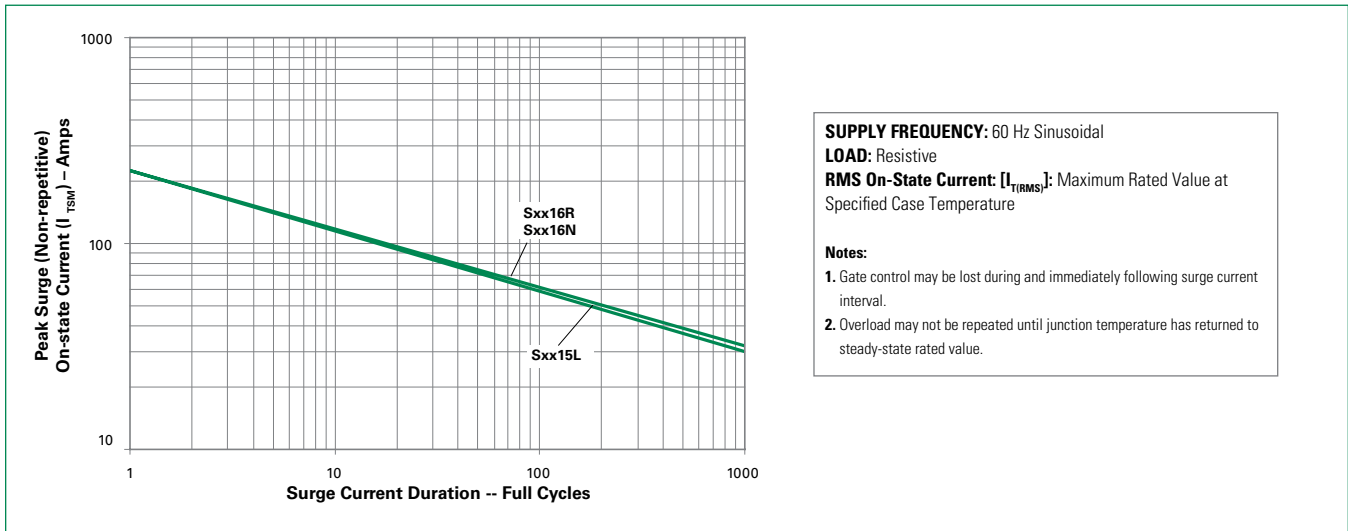
**Figure 10: Peak Capacitor Discharge Current**



**Figure 11: Peak Capacitor Discharge Current Derating**

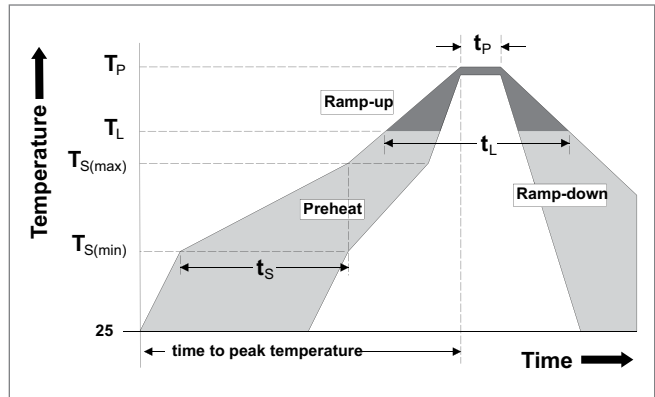


**Figure 12: Surge Peak On-State Current vs. Number of Cycles**



**Soldering Parameters**

<b>Reflow Condition</b>		Pb – Free assembly
<b>Pre Heat</b>	- Temperature Min ( $T_{s(min)}$ )	150°C
	- Temperature Max ( $T_{s(max)}$ )	200°C
	- Time (min to max) ( $t_s$ )	60 – 180 secs
<b>Average ramp up rate (Liquidus Temp) (<math>T_L</math>) to peak</b>		5°C/second max
<b><math>T_{S(max)}</math> to <math>T_L</math> - Ramp-up Rate</b>		5°C/second max
<b>Reflow</b>	- Temperature ( $T_L$ ) (Liquidus)	217°C
	- Temperature ( $t_L$ )	60 – 150 seconds
<b>Peak Temperature (<math>T_p</math>)</b>		260 <sup>+0/-5</sup> °C
<b>Time within 5°C of actual peak Temperature (<math>t_p</math>)</b>		20 – 40 seconds
<b>Ramp-down Rate</b>		5°C/second max
<b>Time 25°C to peak Temperature (<math>T_p</math>)</b>		8 minutes Max.
<b>Do not exceed</b>		280°C



**Additional Information**



Datasheet



Resources



Samples

### Physical Specifications

<b>Terminal Finish</b>	100% Matte Tin-plated
<b>Body Material</b>	UL Recognized epoxy meeting flammability classification 94V-0
<b>Lead Material</b>	Copper Alloy

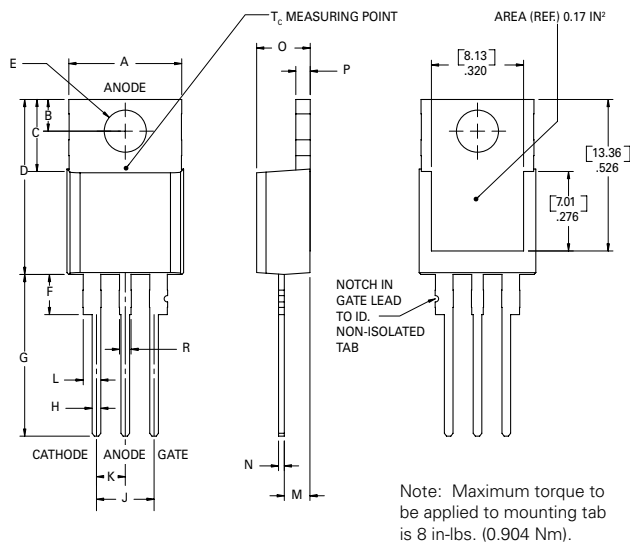
### Design Considerations

Careful selection of the correct device for the application's operating parameters and environment will go a long way toward extending the operating life of the Thyristor. Good design practice should limit the maximum continuous current through the main terminals to 75% of the device rating. Other ways to ensure long life for a power discrete semiconductor are proper heat sinking and selection of voltage ratings for worst case conditions. Overheating, overvoltage (including dv/dt), and surge currents are the main killers of semiconductors. Correct mounting, soldering, and forming of the leads also help protect against component damage.

### Environmental Specifications

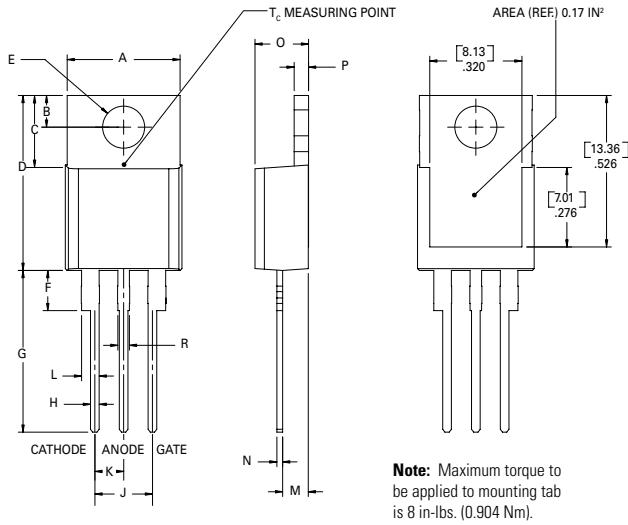
Test	Specifications and Conditions
<b>AC Blocking</b>	MIL-STD-750, M-1040, Cond A Applied Peak AC voltage @ 125°C for 1008 hours
<b>Temperature Cycling</b>	MIL-STD-750, M-1051, 100 cycles; -40°C to +150°C; 15-min dwell-time
<b>Temperature/Humidity</b>	EIA / JEDEC, JESD22-A101 1008 hours; 320V - DC: 85°C; 85% rel humidity
<b>High Temp Storage</b>	MIL-STD-750, M-1031, 1008 hours; 150°C
<b>Low-Temp Storage</b>	1008 hours; -40°C
<b>Resistance to Solder Heat</b>	MIL-STD-750 Method 2031
<b>Solderability</b>	ANSI/J-STD-002, category 3, Test A
<b>Lead Bend</b>	MIL-STD-750, M-2036 Cond E

### Dimensions – TO-220AB (R-Package) – Non-Isolated Mounting Tab Common with Center Lead



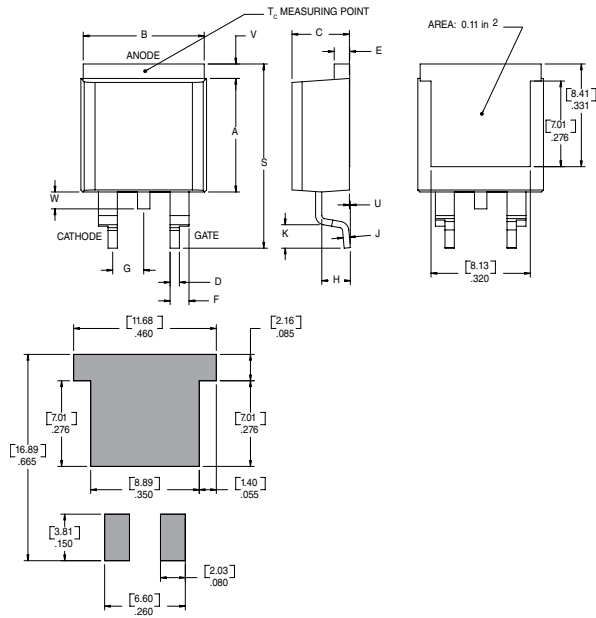
Dimension	Inches		Millimeters	
	Min	Max	Min	Max
<b>A</b>	0.380	0.420	9.65	10.67
<b>B</b>	0.105	0.115	2.67	2.92
<b>C</b>	0.230	0.250	5.84	6.35
<b>D</b>	0.590	0.620	14.99	15.75
<b>E</b>	0.142	0.147	3.61	3.73
<b>F</b>	0.110	0.130	2.79	3.30
<b>G</b>	0.540	0.575	13.72	14.61
<b>H</b>	0.025	0.035	0.64	0.89
<b>J</b>	0.195	0.205	4.95	5.21
<b>K</b>	0.095	0.105	2.41	2.67
<b>L</b>	0.060	0.075	1.52	1.91
<b>M</b>	0.085	0.095	2.16	2.41
<b>N</b>	0.018	0.024	0.46	0.61
<b>O</b>	0.178	0.188	4.52	4.78
<b>P</b>	0.045	0.060	1.14	1.52
<b>R</b>	0.038	0.048	0.97	1.22

**Dimensions — TO-220AB (L-Package) — Isolated Mounting Tab**



Dimension	Inches		Millimeters	
	Min	Max	Min	Max
A	0.380	0.420	9.65	10.67
B	0.105	0.115	2.67	2.92
C	0.230	0.250	5.84	6.35
D	0.590	0.620	14.99	15.75
E	0.142	0.147	3.61	3.73
F	0.110	0.130	2.79	3.30
G	0.540	0.575	13.72	14.61
H	0.025	0.035	0.64	0.89
J	0.195	0.205	4.95	5.21
K	0.095	0.105	2.41	2.67
L	0.060	0.075	1.52	1.91
M	0.085	0.095	2.16	2.41
N	0.018	0.024	0.46	0.61
O	0.178	0.188	4.52	4.78
P	0.045	0.060	1.14	1.52
R	0.038	0.048	0.97	1.22

**Dimensions — TO-263AB (N-package) — D<sup>2</sup>-Pak Surface Mount**



Dimension	Inches		Millimeters	
	Min	Max	Min	Max
A	0.360	0.370	9.14	9.40
B	0.380	0.420	9.65	10.67
C	0.178	0.188	4.52	4.78
D	0.025	0.035	0.64	0.89
E	0.045	0.060	1.14	1.52
F	0.060	0.075	1.52	1.91
G	0.095	0.105	2.41	2.67
H	0.092	0.102	2.34	2.59
J	0.018	0.024	0.46	0.61
K	0.090	0.110	2.29	2.79
S	0.590	0.625	14.99	15.88
V	0.035	0.045	0.89	1.14
U	0.002	0.010	0.05	0.25
W	0.040	0.070	1.02	1.78

**Product Selector**

Part Number	Voltage				Gate Sensitivity	Type	Package
	400V	600V	800V	1000V			
Sxx15L	X	X	X	X	30mA	Standard SCR	TO-220L
Sxx16R	X	X	X	X	30mA	Standard SCR	TO-220R
Sxx16N	X	X	X	X	30mA	Standard SCR	TO-263

Note: xx = Voltage

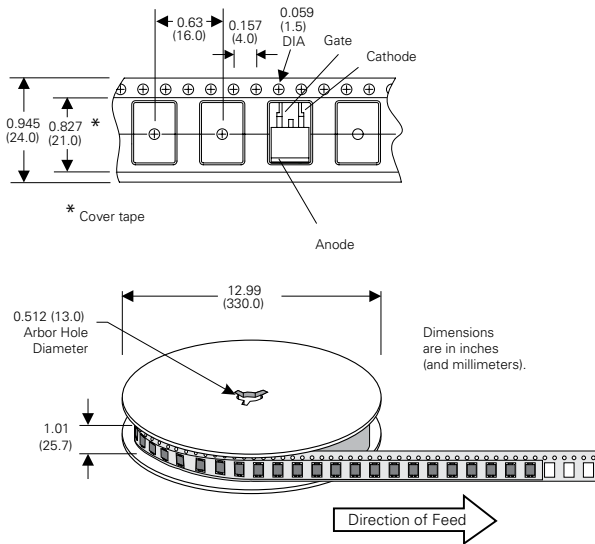
**Packing Options**

Part Number	Marking	Weight	Packing Mode	Base Quantity
Sxx15LTP	Sxx15L	2.2 g	Tube	1000 (50 per tube)
Sxx16RTP	Sxx16R	2.2 g	Tube	1000 (50 per tube)
Sxx16NTP	Sxx16N	1.6 g	Tube	1000 (50 per tube)
Sxx16NRP	Sxx16N	1.6 g	Embossed Carrier	500

Note: xx = Voltage

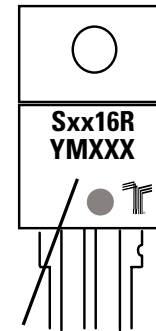
**TO-263 Embossed Carrier Reel Pack (RP) Specs**

Meets all EIA-481-2 Standards



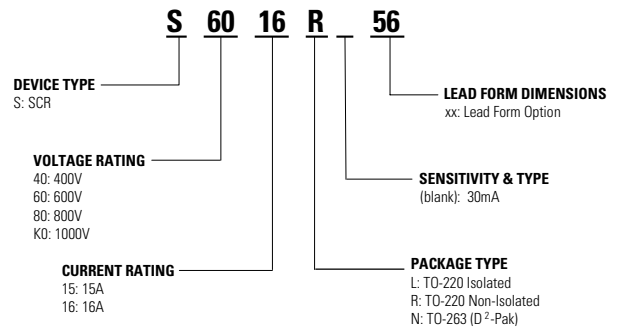
**Part Marking System**

TO-220 AB - (L and R Package)  
TO-263 AB - (N Package)



Date Code Marking  
Y: Year Code  
M: Month Code  
XXX: Lot Trace Code

**Part Numbering System**



**Disclaimer Notice** - Information furnished is believed to be accurate and reliable. However, users should independently evaluate the suitability of and test each product selected for their own applications. Littelfuse products are not designed for, and may not be used in, all applications. Read complete Disclaimer Notice at <http://www.littelfuse.com/disclaimer-electronics>.