

**X-Class
Power MOSFET**
**IXTP32N65X
IXTQ32N65X
IXTH32N65X**
 $V_{DSS} = 650V$
 $I_{D25} = 32A$
 $R_{DS(on)} \leq 135m\Omega$

N-Channel Enhancement Mode

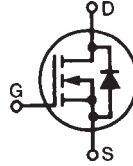

Symbol	Test Conditions	Maximum Ratings	
V_{DSS}	$T_J = 25^\circ C$ to $150^\circ C$	650	V
V_{DGR}	$T_J = 25^\circ C$ to $150^\circ C$, $R_{GS} = 1M\Omega$	650	V
V_{GSS}	Continuous	± 30	V
V_{GSM}	Transient	± 40	V
I_{D25}	$T_C = 25^\circ C$	32	A
I_{DM}	$T_C = 25^\circ C$, Pulse Width Limited by T_{JM}	64	A
dv/dt	$I_S \leq I_{D25}$, $V_{DD} \leq V_{DSS}$, $T_J \leq 150^\circ C$	30	V/ns
P_D	$T_C = 25^\circ C$	500	W
T_J		-55 ... +150	$^\circ C$
T_{JM}		150	$^\circ C$
T_{stg}		-55 ... +150	$^\circ C$
T_L	Maximum Lead Temperature for Soldering	300	$^\circ C$
T_{SOLD}	1.6 mm (0.062in.) from Case for 10s	260	$^\circ C$
M_d	Mounting Torque	1.13 / 10	Nm/lb.in
Weight	TO-220	3.0	g
	TO-3P	5.5	g
	TO-247	6.0	g

Symbol	Test Conditions ($T_J = 25^\circ C$, Unless Otherwise Specified)	Characteristic Values		
		Min.	Typ.	Max.
BV_{DSS}	$V_{GS} = 0V$, $I_D = 250\mu A$	650		V
$V_{GS(th)}$	$V_{DS} = V_{GS}$, $I_D = 250\mu A$	3.0		5.5 V
I_{GSS}	$V_{GS} = \pm 30V$, $V_{DS} = 0V$			± 100 nA
I_{DSS}	$V_{DS} = V_{DSS}$, $V_{GS} = 0V$ $T_J = 125^\circ C$			5 μA
				50 μA
$R_{DS(on)}$	$V_{GS} = 10V$, $I_D = 0.5 \cdot I_{D25}$, Note 1			135 m Ω

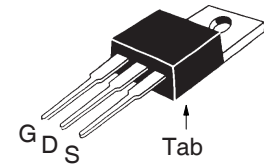
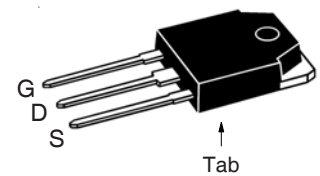
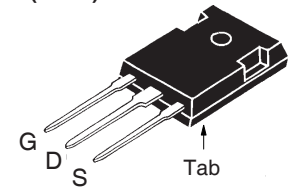
TO-220AB (IXTP)

TO-3P (IXTQ)

TO-247 (IXTH)

 G = Gate D = Drain
 S = Source Tab = Drain

Features

- Low $R_{DS(ON)}$ and Q_G
- Low Package Inductance
- Fast Intrinsic Rectifier

Advantages

- High Power Density
- Easy to Mount
- Space Savings

Applications

- Switch-Mode and Resonant-Mode Power Supplies
- DC-DC Converters
- PFC Circuits
- AC and DC Motor Drives
- Robotics and Servo Controls

Symbol	Test Conditions ($T_J = 25^\circ\text{C}$, Unless Otherwise Specified)	Characteristic Values		
		Min.	Typ.	Max
g_{fs}	$V_{DS} = 10\text{V}$, $I_D = 0.5 \cdot I_{D25}$, Note 1	13	22	S
R_{Gi}	Gate Input Resistance		2.6	Ω
C_{iss}	$V_{GS} = 0\text{V}$, $V_{DS} = 25\text{V}$, $f = 1\text{MHz}$		2205	pF
C_{oss}			1600	pF
C_{rss}			30	pF
Effective Output Capacitance				
$C_{o(er)}$	Energy related	$V_{GS} = 0\text{V}$ $V_{DS} = 0.8 \cdot V_{DSS}$	111	pF
$C_{o(tr)}$	Time related		349	pF
Resistive Switching Times				
$t_{d(on)}$	$V_{GS} = 10\text{V}$, $V_{DS} = 0.5 \cdot V_{DSS}$, $I_D = 0.5 \cdot I_{D25}$ $R_G = 5\Omega$ (External)		23	ns
t_r			49	ns
$t_{d(off)}$			58	ns
t_f			28	ns
$Q_{g(on)}$	$V_{GS} = 10\text{V}$, $V_{DS} = 0.5 \cdot V_{DSS}$, $I_D = 0.5 \cdot I_{D25}$		54	nC
Q_{gs}			12	nC
Q_{gd}			29	nC
R_{thJC}				0.25 $^\circ\text{C/W}$
R_{thCS}	TO-220		0.50	$^\circ\text{C/W}$
	TO-247 & TO-3P		0.25	$^\circ\text{C/W}$

Source-Drain Diode

Symbol	Test Conditions ($T_J = 25^\circ\text{C}$, Unless Otherwise Specified)	Characteristic Values		
		Min.	Typ.	Max
I_S	$V_{GS} = 0\text{V}$			32 A
I_{SM}	Repetitive, pulse Width Limited by T_{JM}			128 A
V_{SD}	$I_F = I_S$, $V_{GS} = 0\text{V}$, Note 1			1.4 V
t_{rr}	$I_F = 16\text{A}$, $-di/dt = 100\text{A}/\mu\text{s}$ $V_R = 100\text{V}$		400	ns
Q_{RM}			6.1	μC
I_{RM}			31	A

Note 1. Pulse test, $t \leq 300\mu\text{s}$, duty cycle, $d \leq 2\%$.

PRELIMINARY TECHNICAL INFORMATION

The product presented herein is under development. The Technical Specifications offered are derived from a subjective evaluation of the design, based upon prior knowledge and experience, and constitute a "considered reflection" of the anticipated result. IXYS reserves the right to change limits, test conditions, and dimensions without notice.

IXYS Reserves the Right to Change Limits, Test Conditions, and Dimensions.

IXYS MOSFETs and IGBTs are covered by one or more of the following U.S. patents:	4,835,592	4,931,844	5,049,961	5,237,481	6,162,665	6,404,065B1	6,683,344	6,727,585	7,005,734B2	7,157,338B2
	4,860,072	5,017,508	5,063,307	5,381,025	6,259,123B1	6,534,343	6,710,405B2	6,759,692	7,063,975B2	
	4,881,106	5,034,796	5,187,117	5,486,715	6,306,728B1	6,583,505	6,710,463	6,771,478B2	7,071,537	

Fig. 1. Output Characteristics @ $T_J = 25^\circ\text{C}$

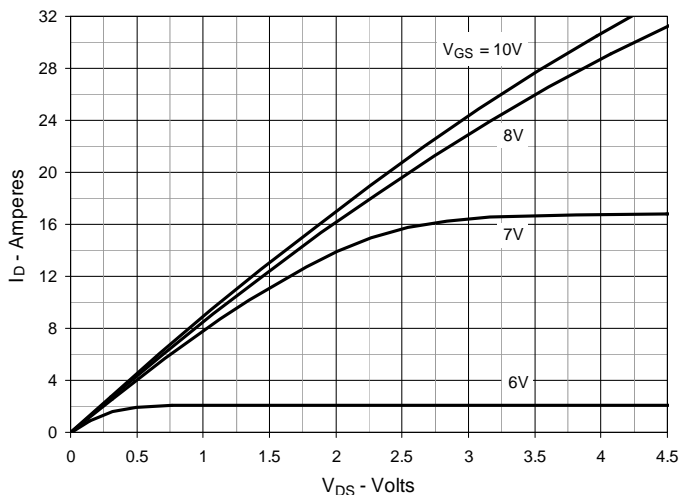

Fig. 2. Extended Output Characteristics @ $T_J = 25^\circ\text{C}$

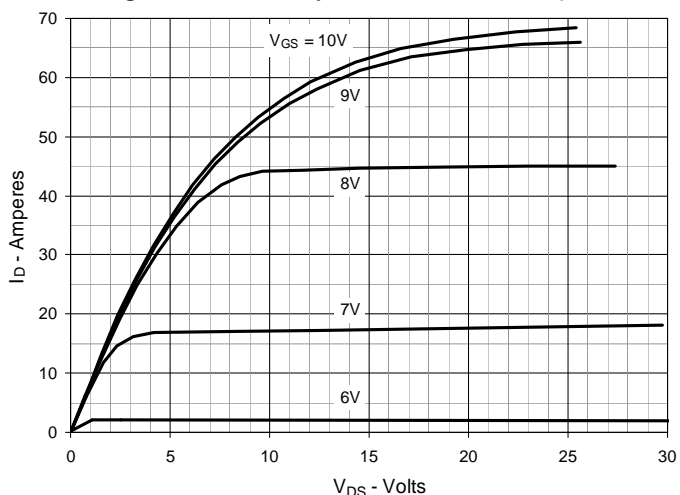

Fig. 3. Output Characteristics @ $T_J = 125^\circ\text{C}$

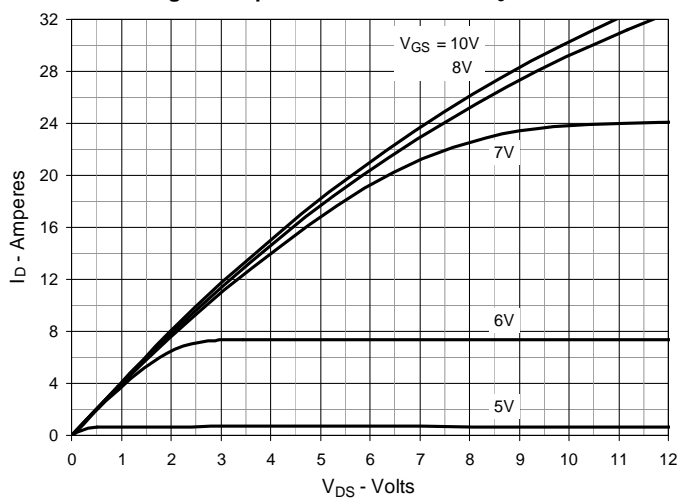

Fig. 4. $R_{DS(on)}$ Normalized to $I_D = 16\text{A}$ Value vs. Junction Temperature

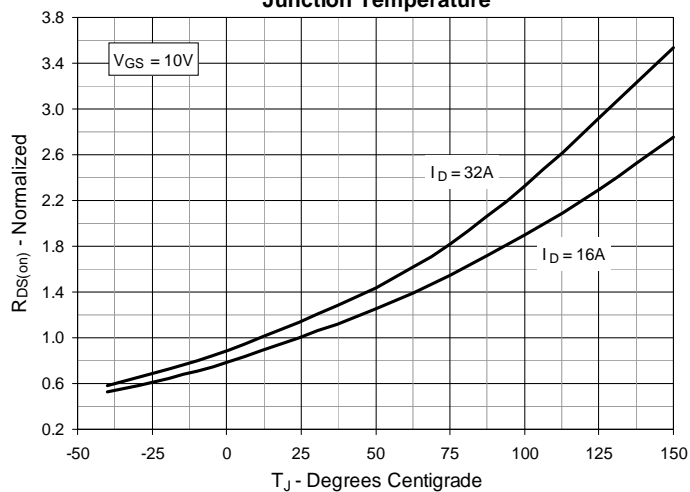

Fig. 5. $R_{DS(on)}$ Normalized to $I_D = 16\text{A}$ Value vs. Drain Current

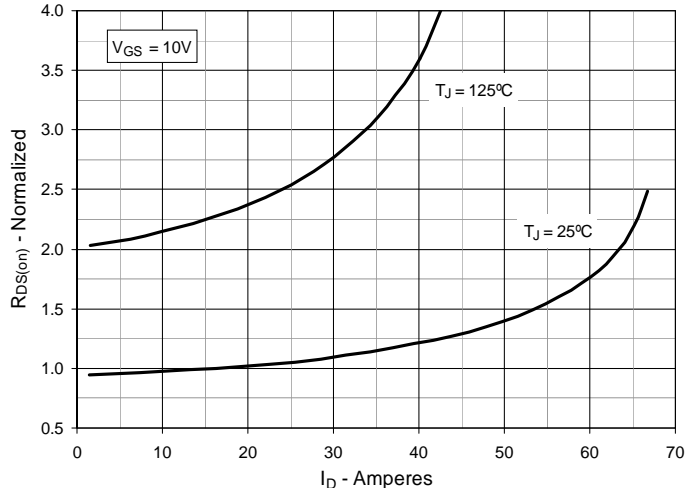

Fig. 6. Normalized Breakdown & Threshold Voltages vs. Junction Temperature

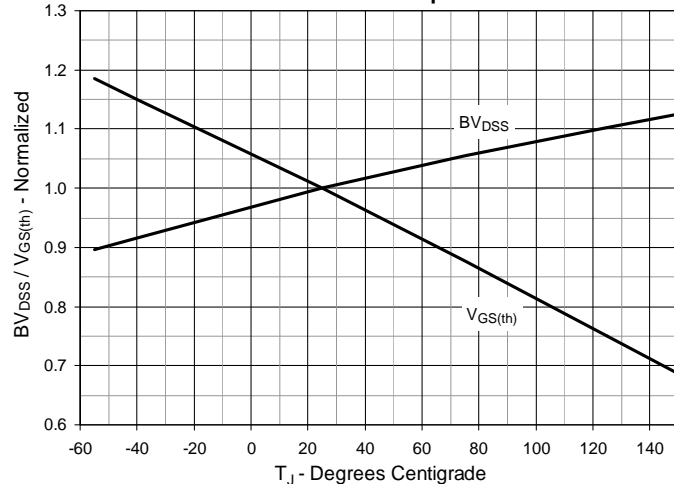

Fig. 7. Maximum Drain Current vs. Case Temperature

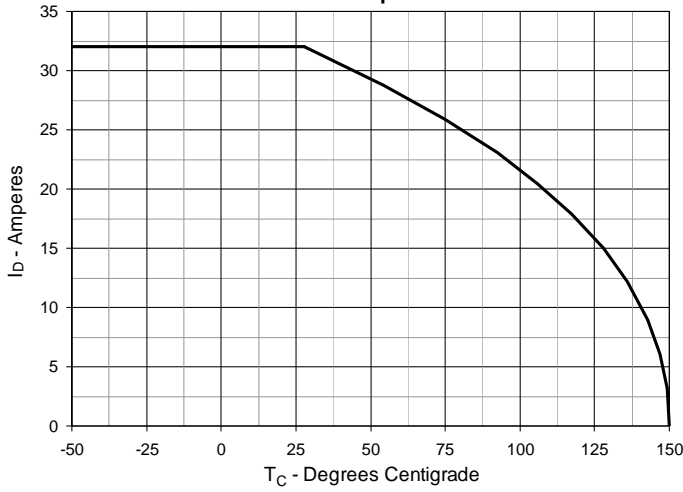

Fig. 8. Input Admittance

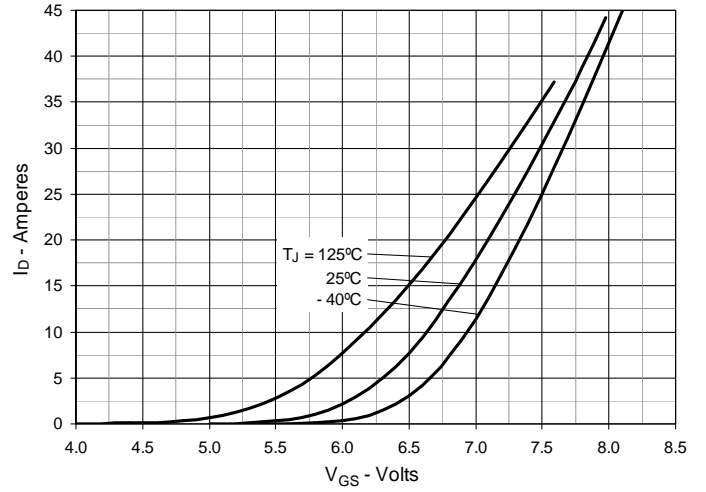

Fig. 9. Transconductance

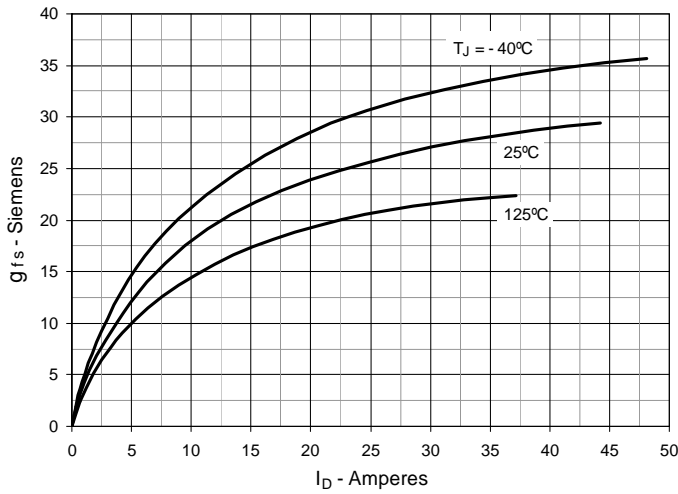

Fig. 10. Forward Voltage Drop of Intrinsic Diode

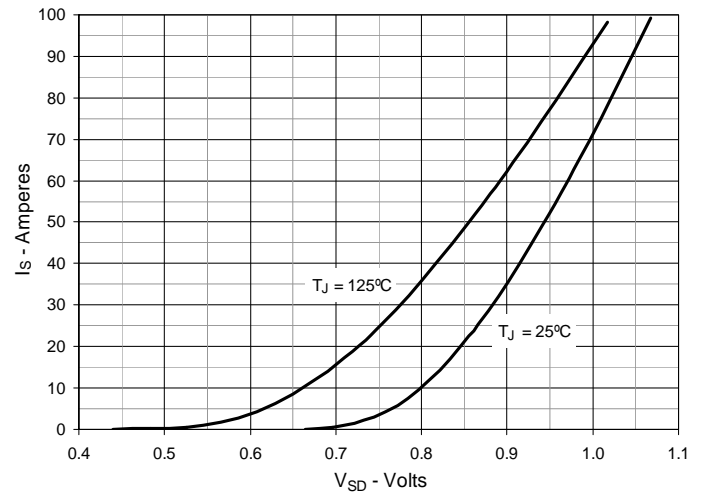

Fig. 11. Gate Charge

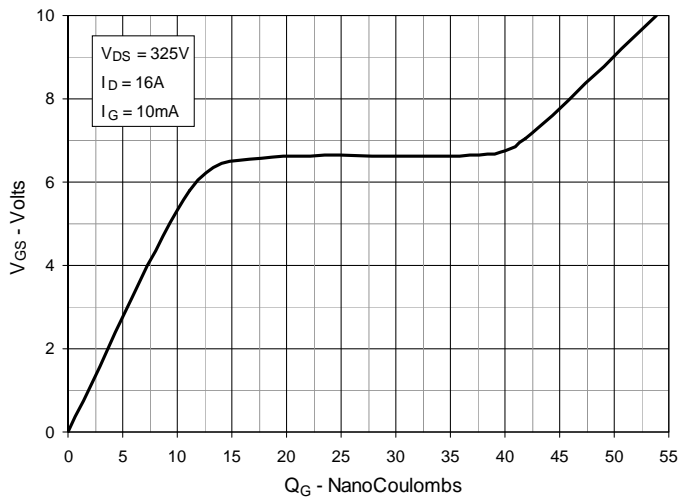

Fig. 12. Capacitance

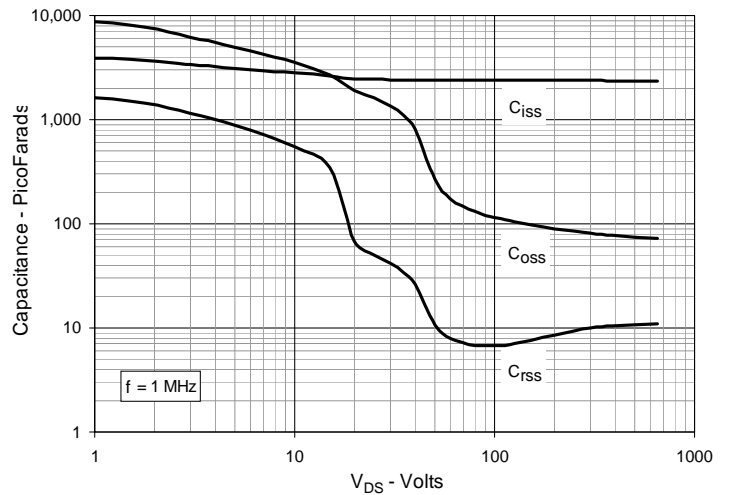

Fig. 13. Output Capacitance Stored Energy

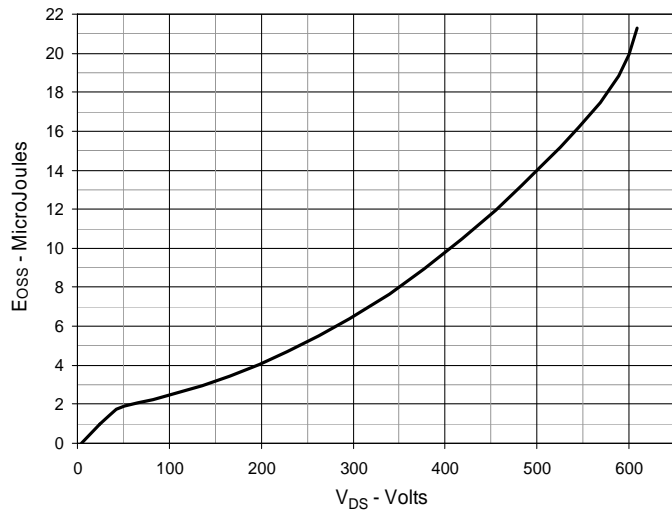

Fig. 14. Forward-Bias Safe Operating Area

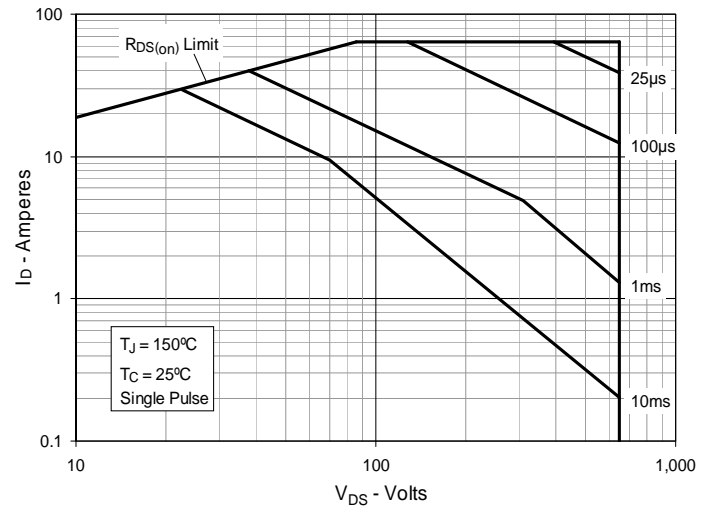
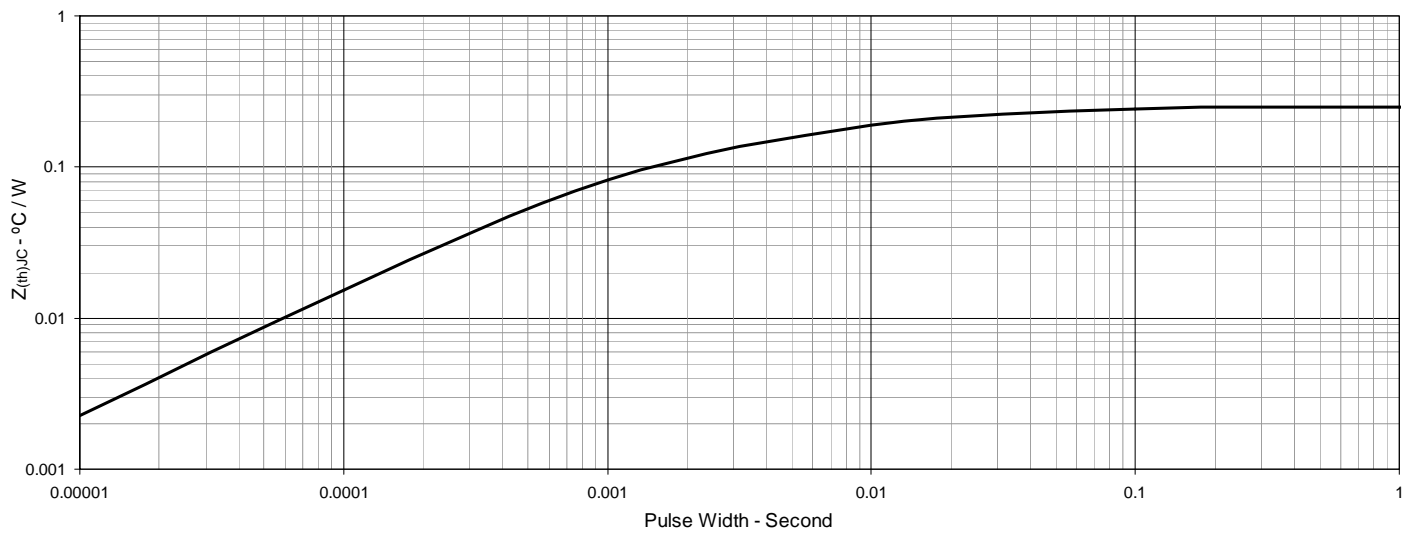
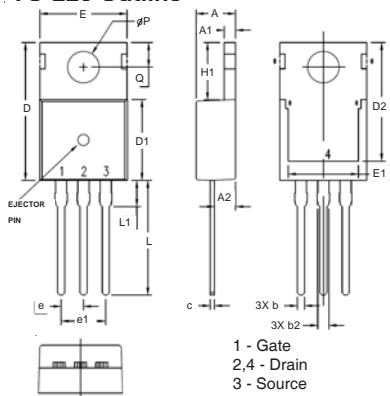

Fig. 15. Maximum Transient Thermal Impedance



TO-220 Outline



SYM	INCHES		MILLIMETERS	
	MIN	MAX	MIN	MAX
A	.169	.185	4.30	4.70
A1	.047	.055	1.20	1.40
A2	.079	.106	2.00	2.70
b	.024	.039	0.60	1.00
b2	.045	.057	1.15	1.45
c	.014	.026	0.35	0.65
D	.587	.626	14.90	15.90
D1	.335	.370	8.50	9.40
(D2)	.500	.531	12.70	13.50
E	.382	.406	9.70	10.30
(E1)	.283	.323	7.20	8.20
e	.100 BSC		2.54 BSC	
e1	.200 BSC		5.08 BSC	
H1	.244	.268	6.20	6.80
L	.492	.547	12.50	13.90
L1	.110	.154	2.80	3.90
ØP	.134	.150	3.40	3.80
Q	.106	.126	2.70	3.20

TO-3P Outline

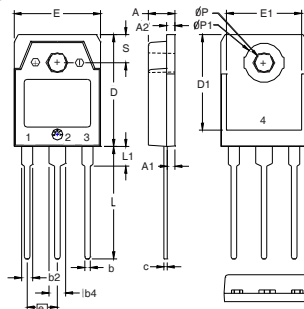

SYM	INCHES		MILLIMETERS	
	MIN	MAX	MIN	MAX
A	.185	.193	4.70	4.90
A1	.051	.059	1.30	1.50
A2	.057	.065	1.45	1.65
b	.035	.045	0.90	1.15
b2	.075	.087	1.90	2.20
b4	.114	.126	2.90	3.20
c	.022	.031	0.55	0.80
D	.780	.799	19.80	20.30
D1	.665	.677	16.90	17.20
E	.610	.622	15.50	15.80
E1	.531	.539	13.50	13.70
e	.215 BSC		5.45 BSC	
L	.779	.795	19.80	20.20
L1	.134	.142	3.40	3.60
ØP	.126	.134	3.20	3.40
ØP1	.272	.280	6.90	7.10
S	.193	.201	4.90	5.10

TO-247 Outline

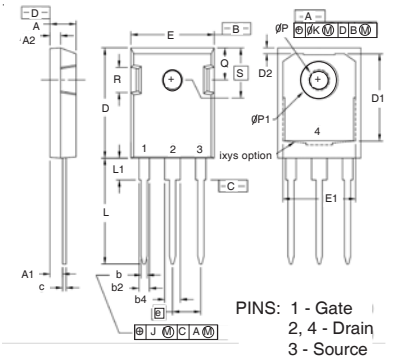

SYM	INCHES		MILLIMETERS	
	MIN	MAX	MIN	MAX
A	.190	.205	4.83	5.21
A1	.090	.100	2.29	2.54
A2	.075	.085	1.91	2.16
b	.045	.055	1.14	1.40
b2	.075	.087	1.91	2.20
b4	.115	.126	2.92	3.20
C	.024	.031	0.61	0.80
D	.819	.840	20.80	21.34
D1	.650	.690	16.51	17.53
D2	.035	.050	0.89	1.27
E	.620	.635	15.75	16.13
E1	.545	.565	13.84	14.35
e	.215 BSC		5.45 BSC	
J	--	.010	--	0.25
K	--	.025	--	0.64
L	.780	.810	19.81	20.57
L1	.150	.170	3.81	4.32
ØP	.140	.144	3.55	3.65
ØP1	.275	.290	6.99	7.37
Q	.220	.244	5.59	6.20
R	.170	.190	4.32	4.83
S	.242 BSC		6.15 BSC	



Disclaimer Notice - Information furnished is believed to be accurate and reliable. However, users should independently evaluate the suitability of and test each product selected for their own applications. Littelfuse products are not designed for, and may not be used in, all applications. Read complete Disclaimer Notice at www.littelfuse.com/disclaimer-electronics.