

AQ3530-01LTG

0.3pF 22kV unidirectional TVS diode

**Description**

This AQ3530 unidirectional diode provides a high level of protection for electronic equipment that may be exposed to electrostatic discharges (ESD). This robust component can safely absorb repetitive ESD strikes above the maximum level specified in the IEC 61000-4-2 international standard (Level 4, $\pm 8\text{kV}$ contact discharge) without performance degradation. The extremely low loading capacitance also makes it ideal for protecting high speed signal pins such as V-By-One®, HDMI, USB3.0, USB2.0, and IEEE 1394.

Features & Benefits

- ESD, IEC 61000-4-2, $\pm 22\text{kV}$ contact, $\pm 30\text{kV}$ air
- EFT, IEC 61000-4-4, 40A (tP=5/50ns)
- Lightning, 2.5A (8/20 μs as defined in IEC 61000-4-5 2nd edition)
- Low capacitance of 0.3pF (TYP) at 3GHz
- ESD, ISO 10605, 330pF 330 Ω , $\pm 26\text{kV}$ contact, $\pm 30\text{kV}$ air
- Facilitates excellent signal integrity
- PPAP capable
- AEC-Q101 qualified
- Halogen free, Lead free and RoHS compliant
- Moisture Sensitivity Level (MSL -1)

Additional Information

Resources



Accessories

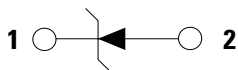

Samples

Pinout**Functional Block Diagram****Applications**

- Ultra-high speed data lines
- USB 3.1, 3.0, 2.0
- HDMI 2.0, 1.4a, 1.3
- DisplayPort(TM)
- V-by-One®
- LVDS interfaces
- Automotive application
- Consumer, mobile and portable electronics
- Tablet PC and external storage with high speed interfaces
- Applications requiring high ESD performance in small packages

AQ3530-01LTG

0.3pF 22kV unidirectional TVS diode

Absolute Maximum Ratings

Symbol	Parameter	Value	Units
I_{PP}	Peak Current ($t_p=8/20\mu s$)	2.5	A
T_{OP}	Operating Temperature	-40 to 150	°C
T_{STOR}	Storage Temperature	-55 to 150	°C

Caution: Stresses above those listed in "Absolute Maximum Ratings" may cause permanent damage to the component. This is a stress only rating and operation of the component at these or any other conditions above those indicated in the operational sections of this specification is not implied.

Electrical Characteristics - ($T_{OP}=25^\circ C$)

Parameter	Symbol	Test Conditions	Min	Typ	Max	Units
Reverse Standoff Voltage	V_{RWM}	$I_R=1\mu A$			5	V
Breakdown Voltage	V_{BR}	$I_R=1mA$	7.5	8.5		V
Reverse Leakage Current	I_{LEAK}	$V_R=5V$		0.02	0.1	μA
Clamp Voltage ¹	V_C	$I_{pp}=2.5A$, $t_p=8/20\mu s$, I/O to GND		12.5	15	V
Dynamic Resistance ²	R_{DYN}	TLP, $t_p=100ns$, I/O to GND		0.78		Ω
ESD Withstand Voltage ¹	V_{ESD}	IEC 61000-4-2 (Contact)	± 22			kV
		IEC 61000-4-2 (Air)	± 30			kV
Diode Capacitance ^{1,3}	$C_{I/O-GND}$	Reverse Bias=0V, $f=3GHz$		0.30		pF

Note:

- Parameter is guaranteed by design and/or component characterization.
- Transmission Line Pulse (TLP) with 100ns width, 2ns rise time, and average window $t_1=70ns$ to $t_2=90ns$.
- Package sizes larger than 0201 can add parasitic capacitance, inductance and resistance.

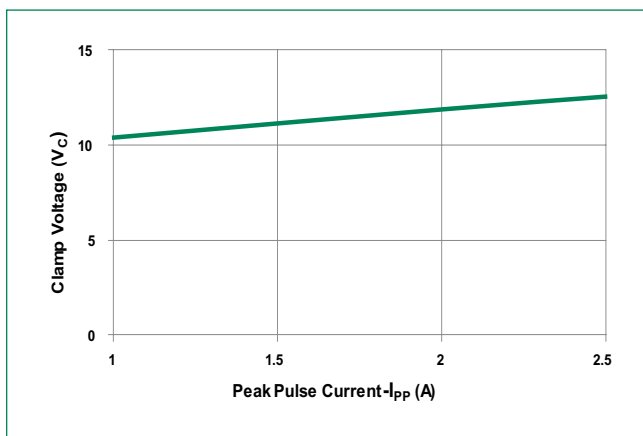
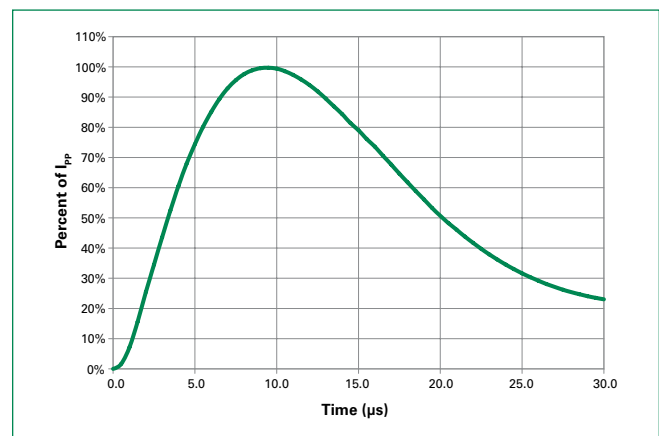
Clamping voltage vs. IPP for 8/20 μs waveshape**8/20 μs Pulse Waveform**

AQ3530-01LTG

0.3pF 22kV unidirectional TVS diode

Positive Transmission Line Pulsing (TLP) Plot

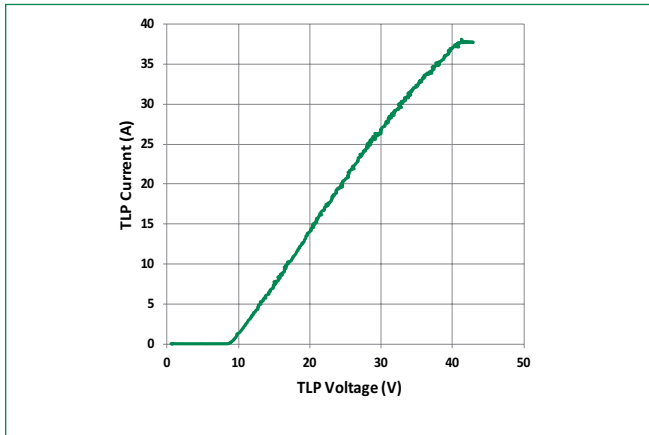

Negative Transmission Line Pulsing (TLP) Plot

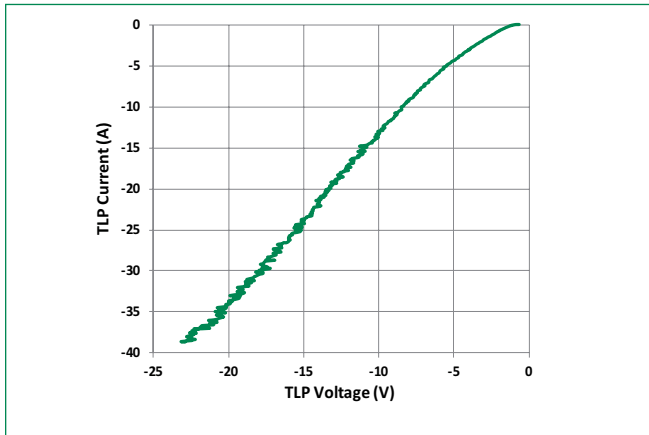

IEC 61000-4-2 +8 kV Contact ESD Clamping Voltage

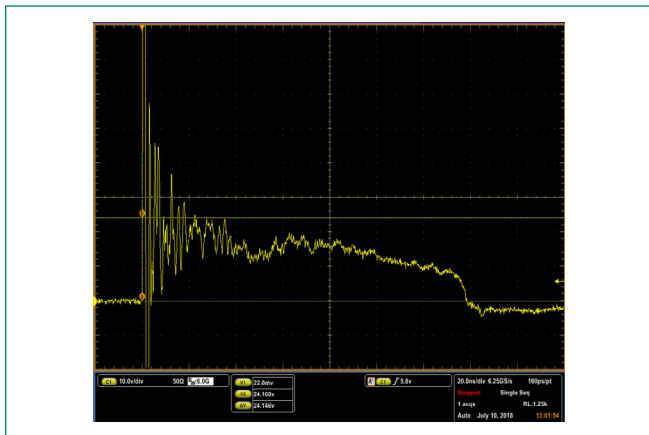

IEC 61000-4-2 -8 kV Contact ESD Clamping Voltage

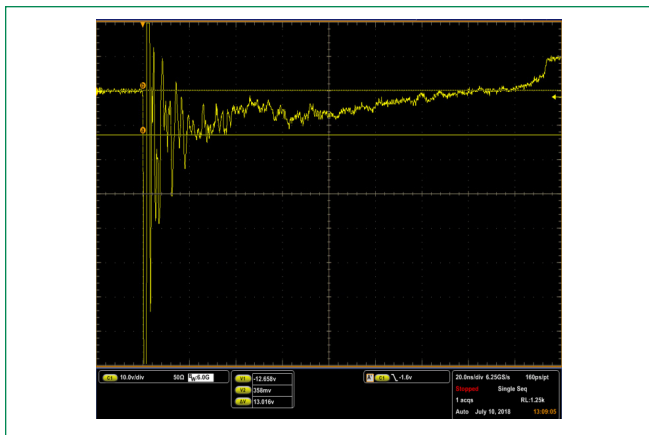

ESD ISO10605 +8 kV Contact ESD Clamping Voltage

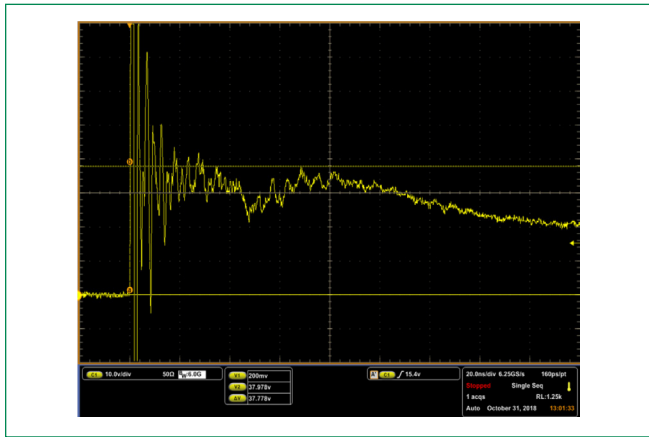

ESD ISO10605 -8 kV Contact ESD Clamping Voltage

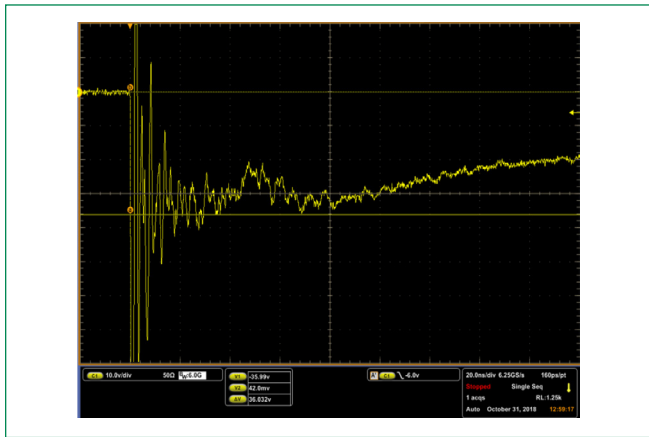

AQ3530-01LTG

0.3pF 22kV unidirectional TVS diode

Soldering Parameters

Reflow Condition		Pb – Free assembly
Pre Heat	- Temperature Min ($T_{s(min)}$)	150°C
	- Temperature Max ($T_{s(max)}$)	200°C
	- Time (min to max) (t_s)	60 – 120 secs
Average ramp up rate (Liquidus) Temp (T_L) to peak		3°C/second max
$T_{S(max)}$ to T_L - Ramp-up Rate		3°C/second max
Reflow	- Temperature (T_L) (Liquidus)	217°C
	- Temperature (t_l)	60 – 150 seconds
Peak Temperature (T_p)		260 ^{+0/-5} °C
Time within 5°C of actual peak Temperature (t_p)		30 seconds
Ramp-down Rate		6°C/second max
Time 25°C to peak Temperature (T_p)		8 minutes Max.
Do not exceed		260°C

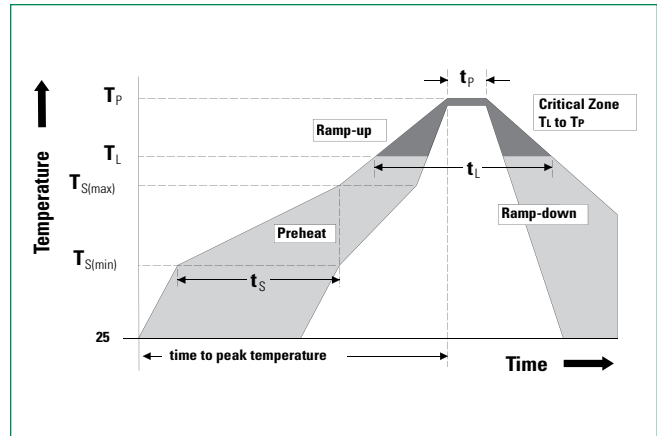
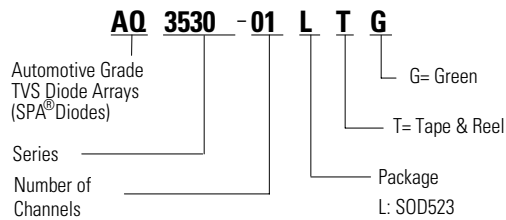
**Part Numbering System****Product Characteristics**

Lead Plating	Matte Tin
Lead Material	Copper Alloy
Lead Coplanarity	0.004 inches(0.102mm)
Substrate Material	Silicon
Body Material	Molded Compound
Flammability	UL Recognized compound meeting flammability rating V-0

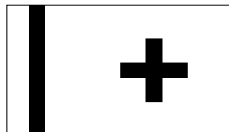
Part Marking System**Ordering Information**

Part Number	Package	Min. Order Qty.
AQ3530-01LTG	SOD523	5000

AQ3530-01LTG

0.3pF 22kV unidirectional TVS diode

Package Dimensions – SOD-523

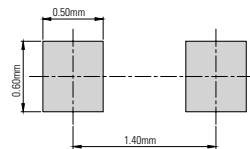
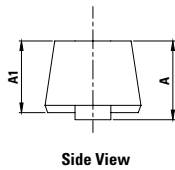
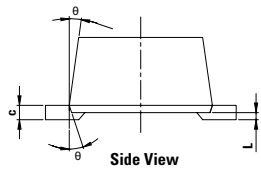
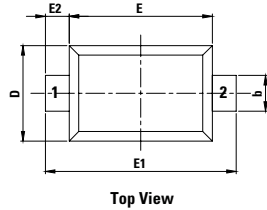

Drawing#: L01-B

Symbol	Millimeters		Inches	
	Min	Max	Min	Max
A	0.51	0.77	0.020	0.030
A1	0.50	0.70	0.020	0.028
b	0.25	0.35	0.010	0.014
c	0.08	0.15	0.003	0.006
D	0.70	0.90	0.028	0.035
E	1.10	1.30	0.043	0.051
E1	1.50	1.70	0.059	0.067
E2	0.20 REF		0.001 REF	
L	0.01	0.07	0.000	0.003
θ	7° REF		7° REF	

Embossed Carrier Tape & Reel Specification – SOD-523

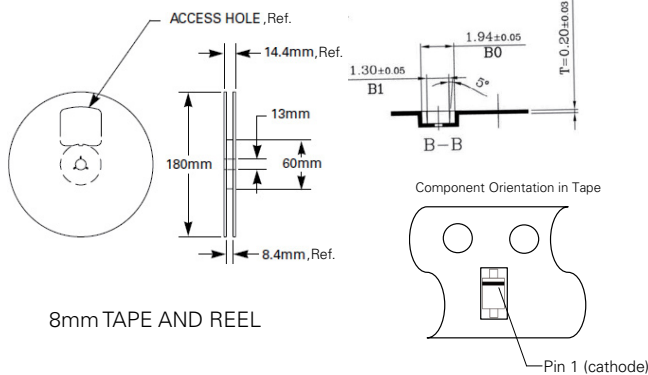
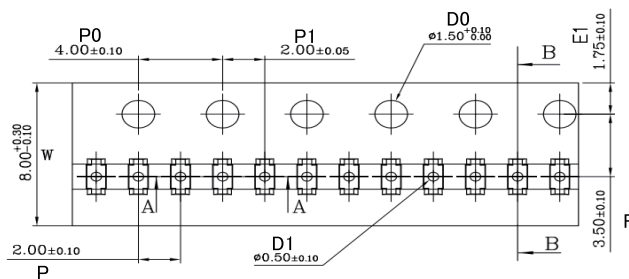

Symbol	Millimeters		Inches	
	Min	Max	Min	Max
A0	0.91	1.01	0.036	0.040
B0	1.89	1.99	0.074	0.078
D0	1.50	1.60	0.059	0.063
D1	0.40	0.60	0.016	0.024
E1	1.65	1.85	0.065	0.073
F	3.40	3.60	0.134	0.142
P0	3.90	4.10	0.154	0.161
P	1.90	2.10	0.075	0.083
P1	1.95	2.05	0.077	0.081
K0	0.68	0.78	0.027	0.031
T	0.17	0.23	0.007	0.009
W	7.90	8.30	0.311	0.327

Disclaimer Notice - Information furnished is believed to be accurate and reliable. However, users should independently evaluate the suitability of and test each product selected for their own applications. Littelfuse products are not designed for, and may not be used in, all applications. Read complete Disclaimer Notice at <http://www.littelfuse.com/disclaimer-electronics>.