

# Polar™ Power MOSFET HiPerFET™

**IXFV22N50P**  
**IXFV22N50PS**  
**IXFH22N50P**

N-Channel Enhancement Mode  
Avalanche Rated  
Fast Intrinsic Diode



$V_{DSS} = 500V$   
 $I_{D25} = 22A$   
 $R_{DS(on)} \leq 270m\Omega$   
 $t_{rr} \leq 200ns$

Symbol	Test Conditions	Maximum Ratings	
$V_{DSS}$	$T_J = 25^\circ C$ to $150^\circ C$	500	V
$V_{DGR}$	$T_J = 25^\circ C$ to $150^\circ C$ , $R_{GS} = 1M\Omega$	500	V
$V_{GSS}$	Continuous	$\pm 30$	V
$V_{GSM}$	Transient	$\pm 40$	V
$I_{D25}$	$T_C = 25^\circ C$	22	A
$I_{DM}$	$T_C = 25^\circ C$ , Pulse Width Limited by $T_{JM}$	50	A
$I_A$	$T_C = 25^\circ C$	22	A
$E_{AS}$	$T_C = 25^\circ C$	750	mJ
$dV/dt$	$I_S \leq I_{DM}$ , $V_{DD} \leq V_{DSS}$ , $T_J \leq 150^\circ C$	10	V/ns
$P_D$	$T_C = 25^\circ C$	350	W
$T_J$		-55 ... +150	$^\circ C$
$T_{JM}$		150	$^\circ C$
$T_{stg}$		-55 ... +150	$^\circ C$
$T_L$	Maximum Lead Temperature for Soldering	300	$^\circ C$
$T_{SOLD}$	Plastic Body for 10s	260	$^\circ C$
$M_d$	Mounting Torque (TO-247)	1.13/10	Nm/lb.in.
$F_C$	Mounting Force (PLUS 220)	11..65/2.5..14.6	N/lb.
<b>Weight</b>	TO-247	6	g
	PLUS 220 types	4	g

PLUS220 (IXFV)

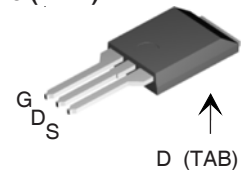

PLUS220SMD (IXFV\_S)

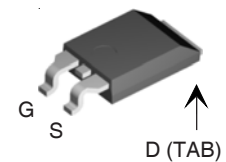

TO-247 (IXFH)

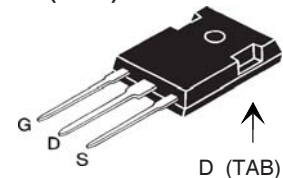

G = Gate    D = Drain  
S = Source    TAB = Drain

## Features

- International Standard Packages
- Avalanche Rated
- Fast Intrinsic Diode
- Low Package Inductance

## Advantages

- High Power Density
- Easy to Mount
- Space Savings

## Applications

- Switched-Mode and Resonant-Mode Power Supplies
- DC-DC Converters
- Laser Drivers
- AC and DC Motor Drives
- Robotics and Servo Controls

Symbol	Test Conditions ( $T_J = 25^\circ C$ , Unless Otherwise Specified)	Characteristic Values		
		Min.	Typ.	Max.
$BV_{DSS}$	$V_{GS} = 0V$ , $I_D = 250\mu A$	500		V
$V_{GS(th)}$	$V_{DS} = V_{GS}$ , $I_D = 2.5mA$	3.0		5.5 V
$I_{GSS}$	$V_{GS} = \pm 30V$ , $V_{DS} = 0V$			$\pm 100$ nA
$I_{DSS}$	$V_{DS} = V_{DSS}$ , $V_{GS} = 0V$ $T_J = 125^\circ C$			15 $\mu A$ 250 $\mu A$
$R_{DS(on)}$	$V_{GS} = 10V$ , $I_D = 0.5 \cdot I_{D25}$ , Note 1			270 m $\Omega$

Symbol	Test Conditions ( $T_J = 25^\circ\text{C}$ Unless Otherwise Specified)	Characteristic Values		
		Min.	Typ.	Max.
$g_{fs}$	$V_{DS} = 20V, I_D = 0.5 \cdot I_{D25}$ , Note 1	12	20	S
$C_{iss}$	$V_{GS} = 0V, V_{DS} = 25V, f = 1\text{MHz}$		2880	pF
$C_{oss}$			310	pF
$C_{rss}$			29	pF
$t_{d(on)}$	<b>Resistive Switching Times</b> $V_{GS} = 10V, V_{DS} = 0.5 \cdot V_{DSS}, I_D = 0.5 \cdot I_{D25}$ $R_G = 10\Omega$ (External)		22	ns
$t_r$			25	ns
$t_{d(off)}$			72	ns
$t_f$			21	ns
$Q_{g(on)}$	$V_{GS} = 10V, V_{DS} = 0.5 \cdot V_{DSS}, I_D = 0.5 \cdot I_{D25}$		50	nC
$Q_{gs}$			16	nC
$Q_{gd}$			18	nC
$R_{thJC}$				0.35 $^\circ\text{C/W}$
$R_{thCS}$	(TO-247 & PLUS220)	0.25		$^\circ\text{C/W}$

**PLUS220 (IXFV) Outline**

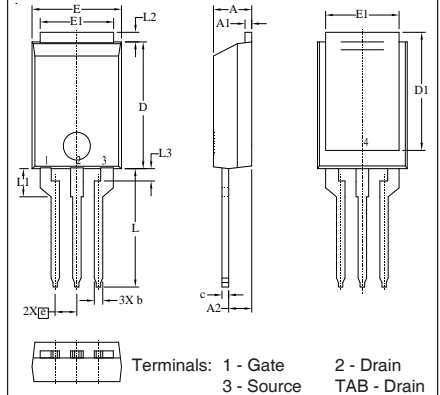

SYM	INCHES		MILLIMETER	
	MIN	MAX	MIN	MAX
A	.169	.185	4.30	4.70
A1	.028	.035	0.70	0.90
A2	.098	.118	2.50	3.00
b	.035	.047	0.90	1.20
c	.028	.035	0.70	0.90
D	.551	.591	14.00	15.00
D1	.512	.539	13.00	13.70
E	.394	.433	10.00	11.00
E1	.331	.346	8.40	8.80
e	.100 BSC		2.54	BSC
L	.512	.551	13.00	14.00
L1	.118	.138	3.00	3.50
L2	.035	.051	0.90	1.30
L3	.047	.059	1.20	1.50

**Source-Drain Diode**

Symbol	Test Conditions ( $T_J = 25^\circ\text{C}$ Unless Otherwise Specified)	Characteristic Values		
		Min.	Typ.	Max.
$I_s$	$V_{GS} = 0V$			22 A
$I_{SM}$	Repetitive, Pulse Width Limited by $T_{JM}$			88 A
$V_{SD}$	$I_F = I_s, V_{GS} = 0V$ , Note 1			1.5 V
$t_{rr}$	$I_F = 22A, -di/dt = 100A/\mu\text{s}$ $V_R = 100V, V_{GS} = 0V$			200 ns
$Q_{RM}$			0.7	$\mu\text{C}$
$I_{RM}$			7.0	A

Note 1: Pulse test,  $t \leq 300\mu\text{s}$ ; duty cycle,  $d \leq 2\%$ .

**TO-247 (IXFH) Outline**

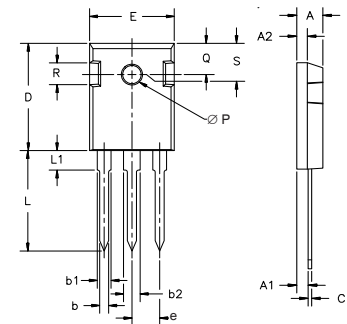

Dim.	Millimeter		Inches	
	Min.	Max.	Min.	Max.
A	4.7	5.3	.185	.209
A <sub>1</sub>	2.2	2.54	.087	.102
A <sub>2</sub>	2.2	2.6	.059	.098
b	1.0	1.4	.040	.055
b <sub>1</sub>	1.65	2.13	.065	.084
b <sub>2</sub>	2.87	3.12	.113	.123
C	.4	.8	.016	.031
D	20.80	21.46	.819	.845
E	15.75	16.26	.610	.640
e	5.20	5.72	0.205	0.225
L	19.81	20.32	.780	.800
L1		4.50		.177
∅P	3.55	3.65	.140	.144
Q	5.89	6.40	0.232	0.252
R	4.32	5.49	.170	.216
S	6.15	BSC	242	BSC

**PLUS220SMD (IXFV\_S) Outline**

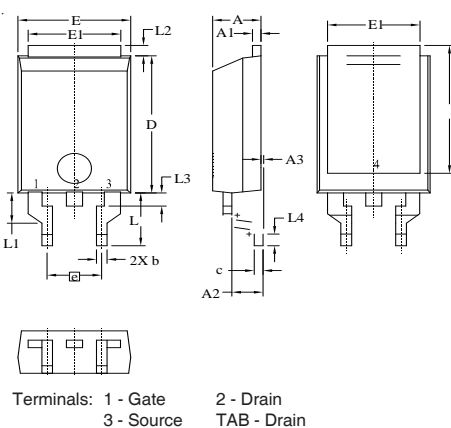

SYM	INCHES		MILLIMETER	
	MIN	MAX	MIN	MAX
A	.169	.185	4.30	4.70
A1	.028	.035	0.70	0.90
A2	.098	.118	2.50	3.00
A3	.000	.010	0.00	0.25
b	.035	.047	0.90	1.20
c	.028	.035	0.70	0.90
D	.551	.591	14.00	15.00
D1	.512	.539	13.00	13.70
E	.394	.433	10.00	11.00
E1	.331	.346	8.40	8.80
e	.200BSC		5.08	BSC
L	.209	.228	5.30	5.80
L1	.118	.138	3.00	3.50
L2	.035	.051	0.90	1.30
L3	.047	.059	1.20	1.50
L4	.039	.059	1.00	1.50

IXYS Reserves the Right to Change Limits, Test Conditions, and Dimensions.

IXYS MOSFETs and IGBTs are covered 4,835,592 4,931,844 5,049,961 5,237,481 6,162,665 6,404,065 B1 6,683,344 6,727,585 7,005,734 B2 7,157,338B2  
by one or more of the following U.S. patents: 4,850,072 5,017,508 5,063,307 5,381,025 6,259,123 B1 6,534,343 6,710,405 B2 6,759,692 7,063,975 B2  
4,881,106 5,034,796 5,187,117 5,486,715 6,306,728 B1 6,583,505 6,710,463 6,771,478 B2 7,071,537

**Fig. 1. Output Characteristics  
@ 25°C**

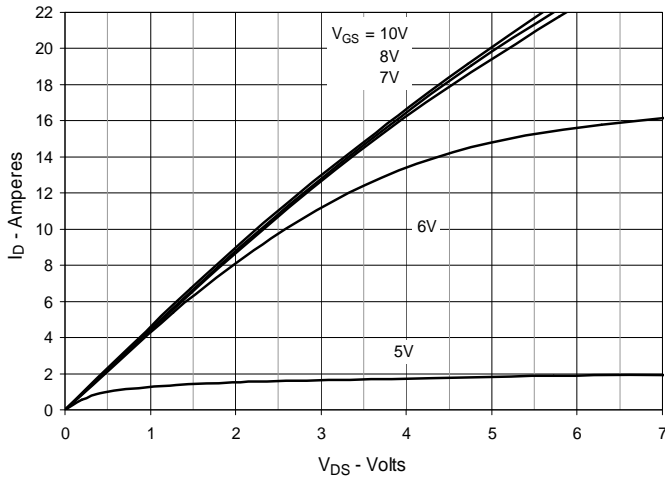

**Fig. 2. Extended Output Characteristics  
@ 25°C**

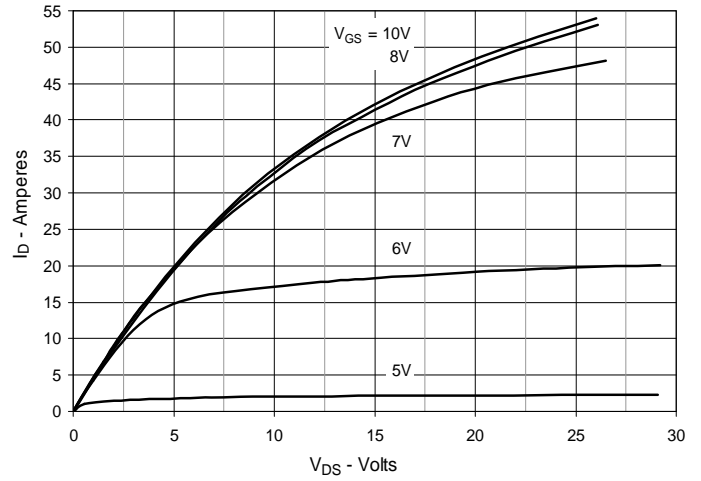

**Fig. 3. Output Characteristics  
@ 125°C**

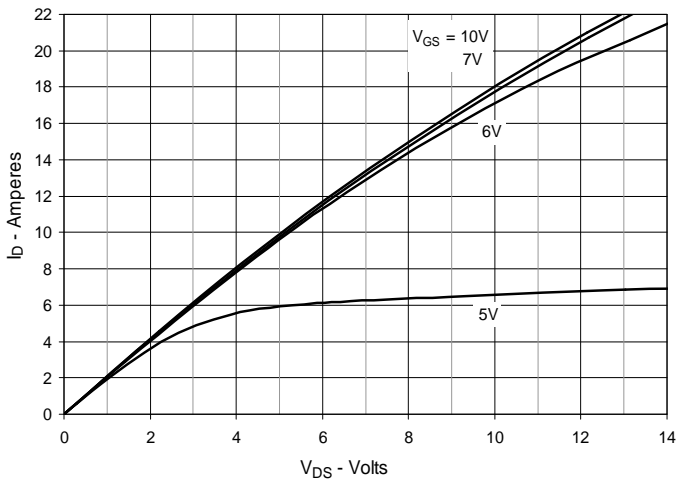

**Fig. 4.  $R_{DS(on)}$  Normalized to  $I_D = 11A$  Value  
vs. Junction Temperature**

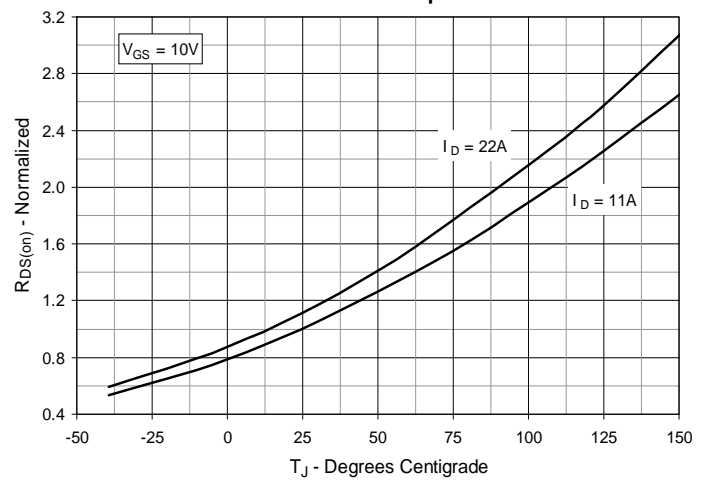

**Fig. 5.  $R_{DS(on)}$  Normalized to  $I_D = 11A$  Value  
vs. Drain Current**

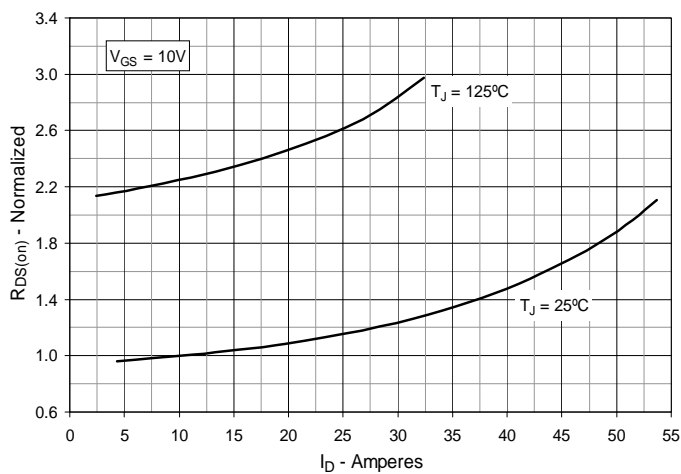

**Fig. 6. Maximum Drain Current vs.  
Case Temperature**

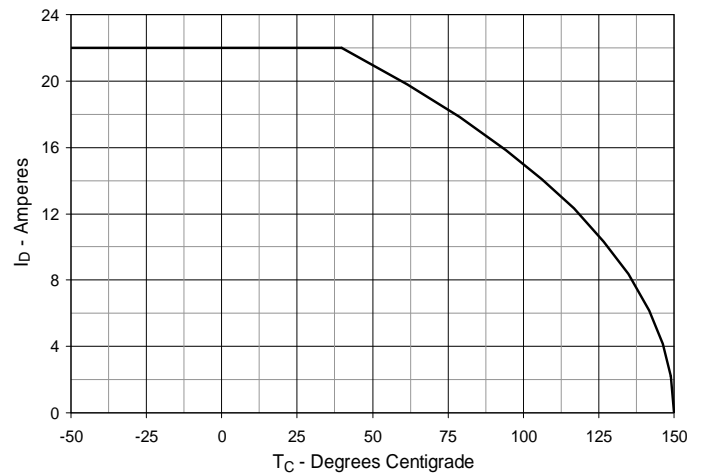

Fig. 7. Input Admittance

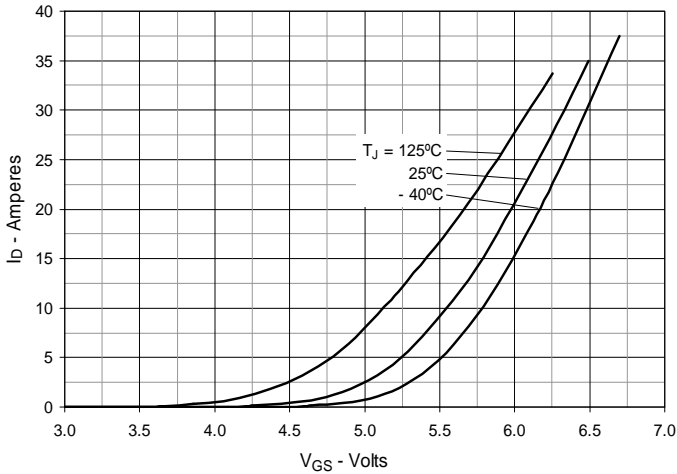

Fig. 8. Transconductance

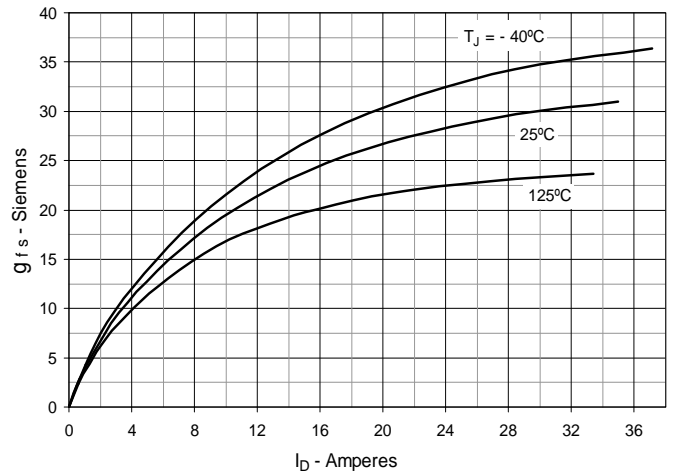

Fig. 9. Forward Voltage Drop of Intrinsic Diode

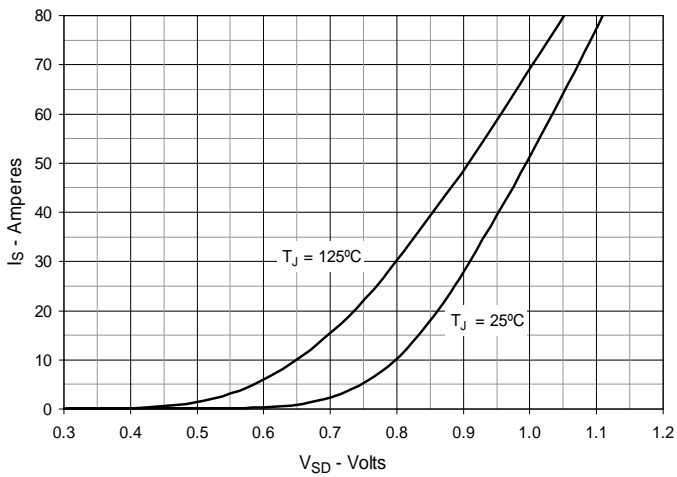

Fig. 10. Gate Charge

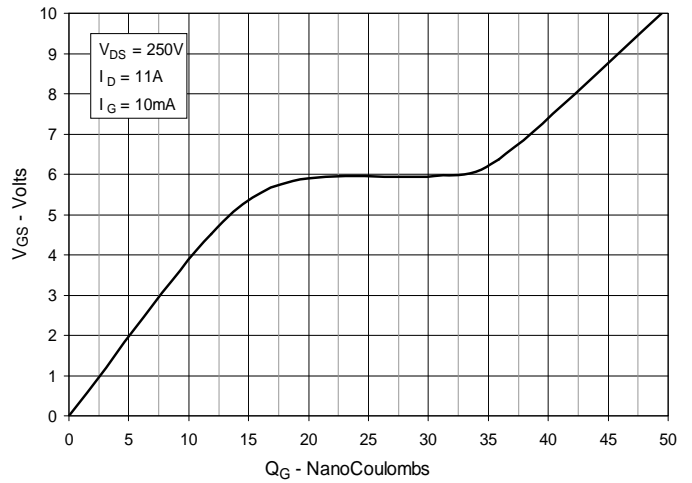

Fig. 11. Capacitance

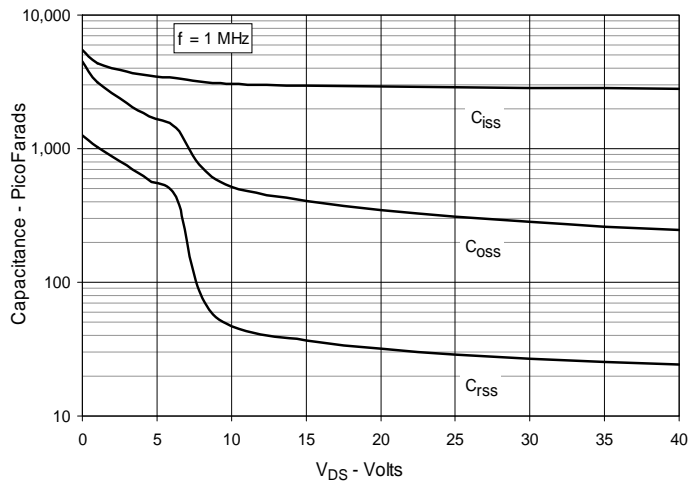

Fig. 12. Forward-Bias Safe Operating Area

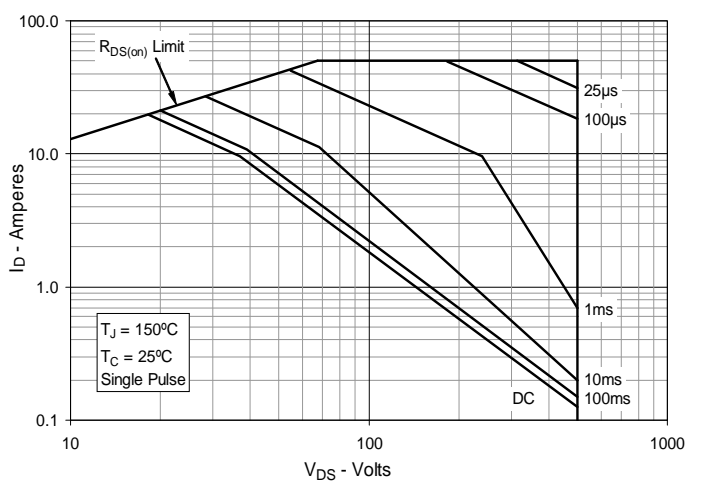
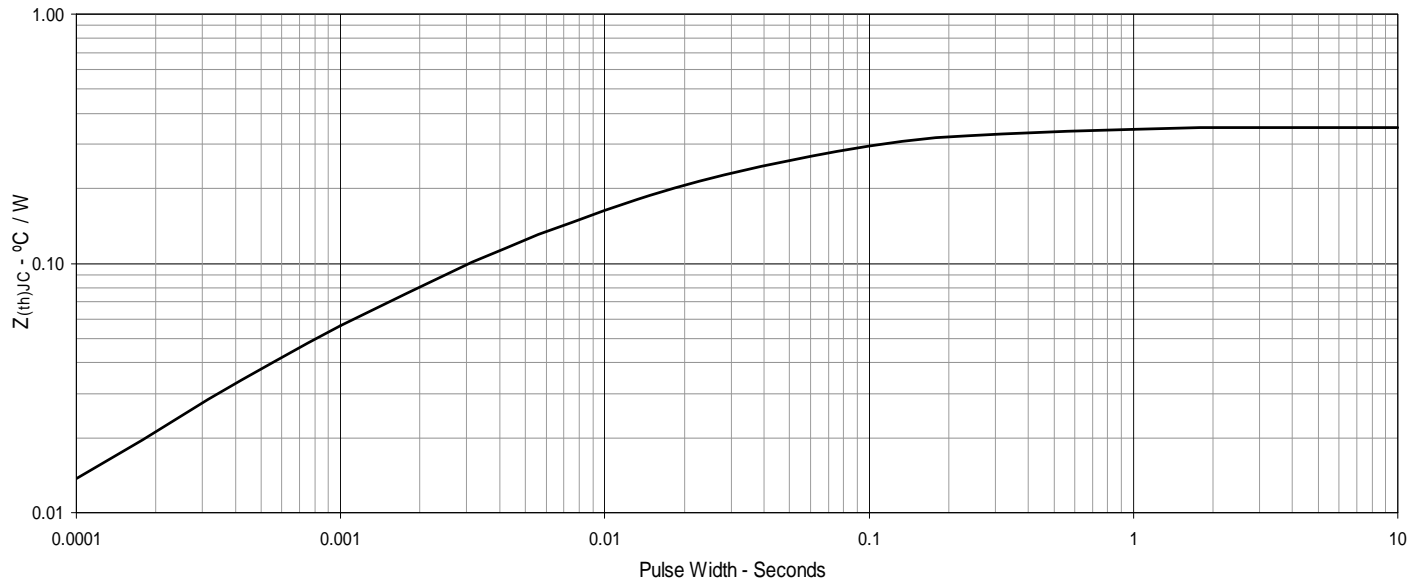

Fig. 13. Maximum Transient Thermal Impedance





---

Disclaimer Notice - Information furnished is believed to be accurate and reliable. However, users should independently evaluate the suitability of and test each product selected for their own applications. Littelfuse products are not designed for, and may not be used in, all applications. Read complete Disclaimer Notice at [www.littelfuse.com/disclaimer-electronics](http://www.littelfuse.com/disclaimer-electronics).