

SMF Series

Surface Mount – 200W



Additional Information



Resources



Accessories



Samples

Agency Approvals

Agency	Agency File Number
	E230531

Maximum Ratings and Thermal Characteristics

($T_A=25^{\circ}\text{C}$ unless otherwise noted)

Parameter	Symbol	Value	Unit
Peak Pulse Power Dissipation at $T_A=25^{\circ}\text{C}$ ¹	P_{PPM}	1000	W
8/20 μs		200	
10/1000 μs ²			
Power Dissipation On Infinite Heat Sink at $T_L=50^{\circ}\text{C}$	P_D	1	W
Thermal Resistance Junction- to- Ambient	$R_{\theta JA}$	220	$^{\circ}\text{C}/\text{W}$
Thermal Resistance Junction- to- Lead	$R_{\theta JL}$	100	$^{\circ}\text{C}/\text{W}$
Operating Temperature Range	T_J	-65 to 150	$^{\circ}\text{C}$
Storage Temperature Range	T_{STG}	-65 to 175	$^{\circ}\text{C}$

Notes:

- Non-repetitive current pulse, per Fig. 4 and derated above T_J (initial) $=25^{\circ}\text{C}$ per Fig. 3.
- SMF90A-SMF100A Peak Pulse Power Dissipation is 170W min, 200W typical @ 10/1000 μs

Description

The SMF series is designed specifically to protect sensitive electronic equipment from voltage transients induced by lightning and other transient voltage events.

SMF package is 50% smaller in footprint when compare to SMA package and delivering one of the low height profiles (1.1mm) in the industry.

Features & Benefits

- 200W peak pulsepower capability at 10/1000 μs waveform, repetition rate (duty cycle): 0.01%
- Compatible with industrial standard package SOD-123FL
- Low profile: maximum height of 1.1mm.
- Low inductance, excellent clamping capability
- For surface mounted applications to optimize board space
- High temperature to reflow soldering guaranteed: $260^{\circ}\text{C}/30\text{sec}$
- Typical failure mode is short from over-specified voltage or current
- Whisker test is conducted based on JEDEC JESD201A per its table 4a and 4c
- IEC-61000-4-2 ESD 30kV(Air), 30kV (Contact)
- ESD protection of data lines in accordance with IEC 61000-4-2
- EFT protection of data lines in accordance with IEC 61000-4-4
- Fast response time: typically less than 1.0ns from 0 Volts to $V_{BR\ min}$
- Glass passivated junction
- Built-in strain relief
- Plastic package is flammability rated V-0 per UL 94
- Meet MSL level1, per J-STD-020, LF maximum peak of 260°C
- Matte tin lead-free plated
- Halogen-free and RoHS compliant
- Pb-free E3 means 2nd level interconnect is Pb-free and the terminal finish material is tin(Sn) (IPC/ JEDEC J-STD-609A.01)
- UL Recognized to UL 497B as an Isolated Loop Circuit Protector.

Applications

SMF series is ideal for the protection of I/O interfaces, V_{CC} bus and other vulnerable circuit used in cellular phones, portable electronics, business machines, power supplies and other consumer applications.

Functional Diagram



Bi-directional



Uni-directional

SMF Series

Surface Mount – 200W

Electrical Characteristics ($T_A=25^\circ\text{C}$ unless otherwise noted)

Part Number		Marking Code		Breakdown Voltage VBR (Volts) @ IT		Test Current IT (mA)	Reverse Stand off Voltage VR (V)	Maximum Reverse Leakage @ VR IR (μA)	Maximum Peak Pulse Current Ipp (A) 10^*1000us	Maximum Clamping Voltage @Ipp VC (V) 10^*1000us	Agency Approval	
Uni	Bi	Uni	Bi	MIN	MAX						Uni	Bi
SMF5.0A	SMF5.0CA	AE	HE	6.40	7.00	10	5.0	400	21.7	9.2	X	X
SMF6.0A	SMF6.0CA	AG	HG	6.67	7.37	10	6.0	400	19.4	10.3	X	X
SMF6.5A	SMF6.5CA	AK	HK	7.22	7.98	10	6.5	250	17.9	11.2	X	X
SMF7.0A	SMF7.0CA	AM	HM	7.78	8.60	10	7.0	100	16.7	12.0	X	X
SMF7.5A	SMF7.5CA	AP	HP	8.33	9.21	1	7.5	50	15.5	12.9	X	X
SMF8.0A	SMF8.0CA	AR	HR	8.89	9.83	1	8.0	25	14.7	13.6	X	X
SMF8.5A	SMF8.5CA	AT	HT	9.44	10.40	1	8.5	10	13.9	14.4	X	X
SMF9.0A	SMF9.0CA	AV	HV	10.00	11.10	1	9.0	2.5	13.0	15.4	X	X
SMF10A	SMF10CA	AX	HX	11.10	12.30	1	10	2.5	11.8	17.0	X	X
SMF11A	SMF11CA	AZ	HZ	12.20	13.50	1	11	2.5	11.0	18.2	X	X
SMF12A	SMF12CA	BE	IE	13.30	14.70	1	12	2.5	10.1	19.9	X	X
SMF13A	SMF13CA	BG	IG	14.40	15.90	1	13	1.0	9.3	21.5	X	X
SMF14A	SMF14CA	BK	IK	15.60	17.20	1	14	1.0	8.6	23.2	X	X
SMF15A	SMF15CA	BM	IM	16.70	18.50	1	15	1.0	8.2	24.4	X	X
SMF16A	SMF16CA	BP	IP	17.80	19.70	1	16	1.0	7.7	26.0	X	X
SMF17A	SMF17CA	BR	IR	18.90	20.90	1	17	1.0	7.2	27.6	X	X
SMF18A	SMF18CA	BT	IT	20.0 0	22.10	1	18	1.0	6.8	29.2	X	X
SMF20A	SMF20CA	BV	IV	22.20	24.50	1	20	1.0	6.2	32.4	X	X
SMF22A	SMF22CA	BX	IX	24.40	26.90	1	22	1.0	5.6	35.5	X	X
SMF24A	SMF24CA	BZ	IZ	26.70	29.50	1	24	1.0	5.1	38.9	X	X
SMF26A	SMF26CA	CE	JE	28.90	31.90	1	26	1.0	4.8	42.1	X	X
SMF28A	SMF28CA	CG	JG	31.10	34.40	1	28	1.0	4.4	45.4	X	X
SMF30A	SMF30CA	CK	JK	33.30	36.80	1	30	1.0	4.1	48.4	X	X
SMF33A	SMF33CA	CM	JM	36.70	40.60	1	33	1.0	3.8	53.3	X	X
SMF36A	SMF36CA	CP	JP	40.00	44.20	1	36	1.0	3.4	58.1	X	X
SMF40A	SMF40CA	CR	JR	44.40	49.10	1	40	1.0	3.1	64.5	X	X
SMF43A	SMF43CA	CT	JT	47.80	52.80	1	43	1.0	2.9	69.4	X	X
SMF45A	SMF45CA	CV	JV	50.00	55.30	1	45	1.0	2.8	72.7	X	X
SMF48A	SMF48CA	CX	JX	53.30	58.90	1	48	1.0	2.6	77.4	X	X
SMF51A	SMF51CA	CZ	JZ	56.70	62.70	1	51	1.0	2.4	82.4	X	X
SMF54A	SMF54CA	DE	KE	60.00	66.30	1	54	1.0	2.3	87.1	X	X
SMF58A	SMF58CA	RG	KG	64.40	71.20	1	58	1.0	2.1	93.6	X	X
SMF60A	SMF60CA	RK	KK	66.70	73.70	1	60	1.0	2.1	96.8	X	X
SMF64A	SMF64CA	RM	KM	71.10	78.60	1	64	1.0	1.9	103.0	X	X
SMF70A	SMF70CA	RP	KP	77.80	86.00	1	70	1.0	1.7	113.0	X	X
SMF75A	SMF75CA	RR	KR	83.30	92.10	1	75	1.0	1.6	121.0	X	X
SMF78A	SMF78CA	RT	KT	86.70	95.80	1	78	1.0	1.6	126.0	X	X
SMF85A	SMF85CA	RV	KV	94.40	104.00	1	85	1.0	1.5	137.0	X	X
SMF90A	-	RW	-	100.00	111.00	1	90	1.0	1.2	146.0	-	-
SMF100A	-	RX	-	111.00	123.00	1	100	1.0	1.1	162.0	-	-
SMF110A	-	SE	-	122.00	135.00	1	110	1.0	1.1	177.0	-	-
SMF120A	-	SG	-	133.00	147.00	1	120	1.0	1.0	193.0	-	-
SMF130A	-	SK	-	144.00	159.00	1	130	1.0	1.0	209.0	-	-
SMF150A	-	SM	-	167.00	185.00	1	150	1.0	0.8	243.0	-	-
SMF160A	-	SP	-	178.00	197.00	1	160	1.0	0.8	259.0	-	-
SMF170A	-	SR	-	189.00	209.00	1	170	1.0	0.7	275.0	-	-
SMF180A	-	ST	-	201.00	222.00	1	180	1.0	0.7	292.0	-	-
SMF188A	-	SV	-	209.00	231.00	1	188	1.0	0.7	304.0	-	-
SMF200A	-	SX	-	224.00	247.00	1	200	1.0	0.6	324.0	-	-
SMF220A	-	SZ	-	246.00	272.00	1	220	1.0	0.6	356.0	-	-
SMF250A	-	TE	-	279.00	309.00	1	250	1.0	0.5	405.0	-	-

Notes:

- V_{BR} measured after I_T applied for 300 μs , I_T = square wave pulse or equivalent.
- Surge current waveform per 10/1000 μs exponential wave and derated per Fig.2.

3. All terms and symbols are consistent with ANSI/IEEE C62.35.

- For bidirectional type having VR of 10 volts and less, the IR limit is double.

SMF Series

Surface Mount – 200W

I-V Curve Characteristics

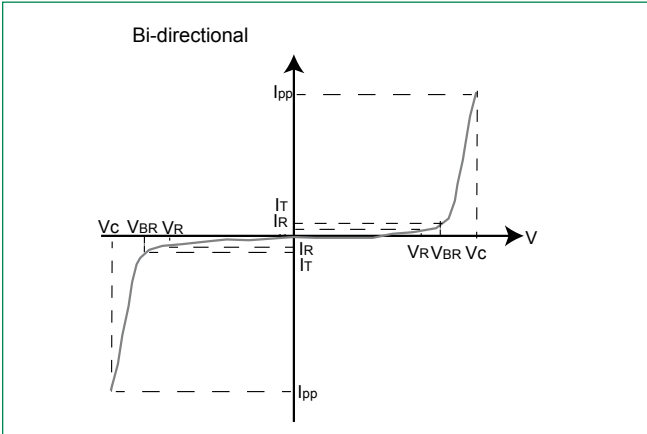
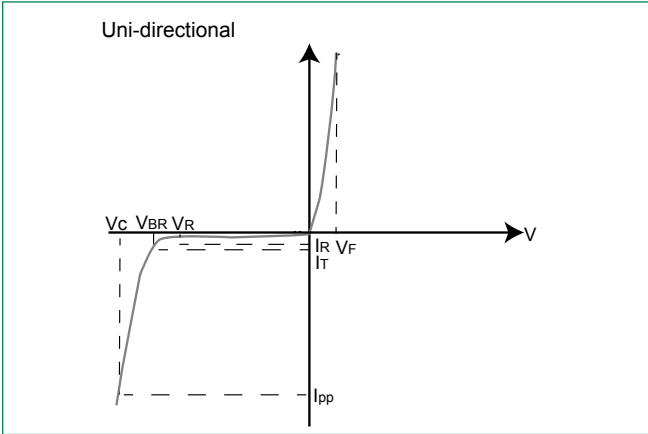

- P_{PPM}** Peak Pulse Power Dissipation – Max power dissipation
- V_R** Stand-off Voltage – Maximum voltage that can be applied to the TVS without operation
- V_{BR}** Breakdown Voltage – Maximum voltage that flows though the TVS at a specified test current (I_T)
- V_C** Clamping Voltage – Peak voltage measured across the TVS at a specified I_{ppm} (peak impulse current)
- I_R** Reverse Leakage Current – Current measured at V_R
- V_F** Forward Voltage Drop for Uni-directional

Ratings and Characteristic Curves ($T_A=25^\circ\text{C}$ unless otherwise noted)

Figure 1: TVS Transients Clamping Waveform

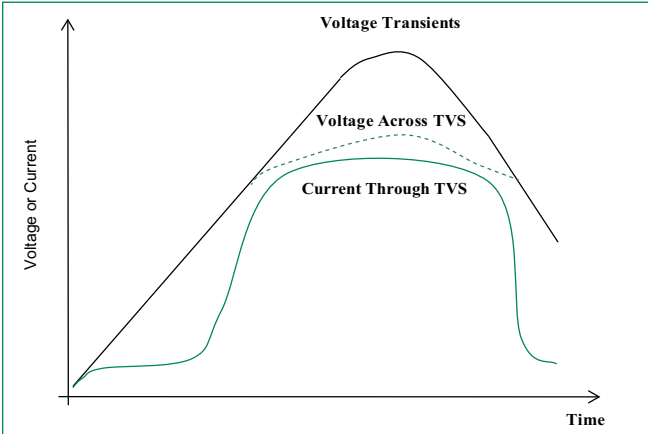
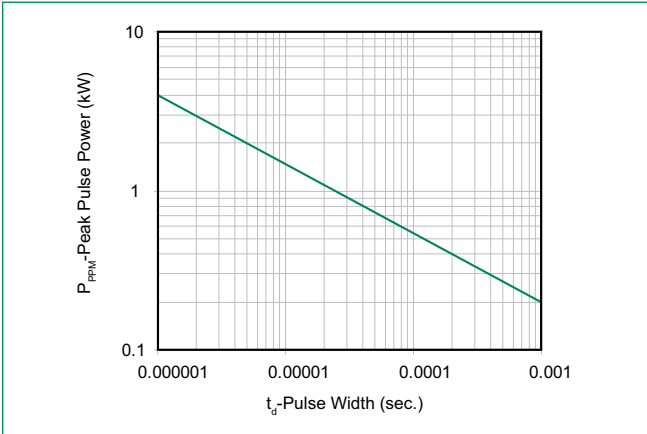

Figure 2: Peak Pulse Power Rating Curve



SMF Series

Surface Mount – 200W

Ratings and Characteristic Curves ($T_A=25^\circ\text{C}$ unless otherwise noted) (Continued)

Figure 3: Peak Pulse Power Derating Curve

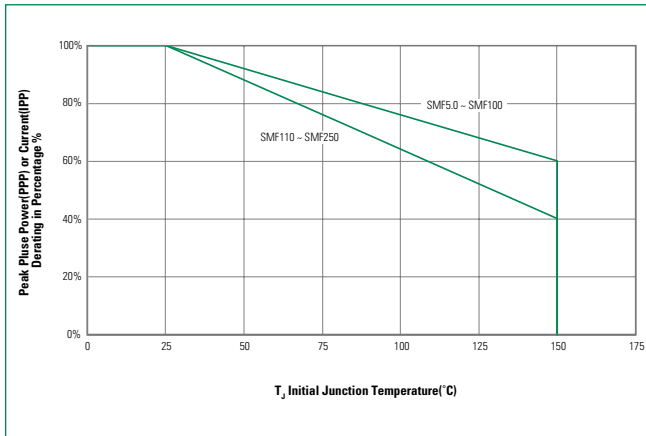

Figure 4: Pulse Waveform - 10/1000 μs

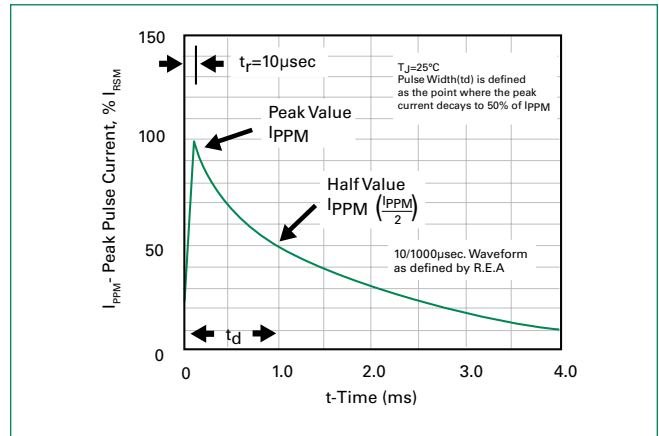

Figure 5: Forward Voltage

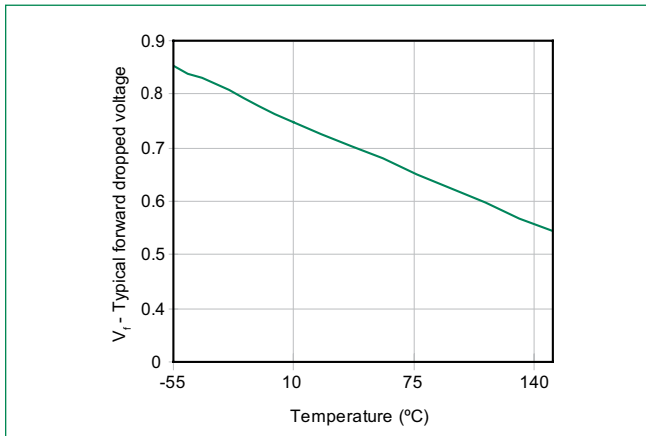

Figure 6: Typical Junction Capacitance

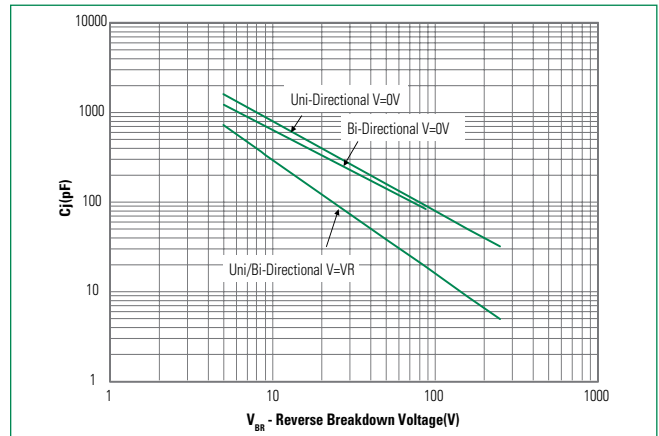

Figure 7: Peak Forward Voltage Drop vs. Peak Forward Current

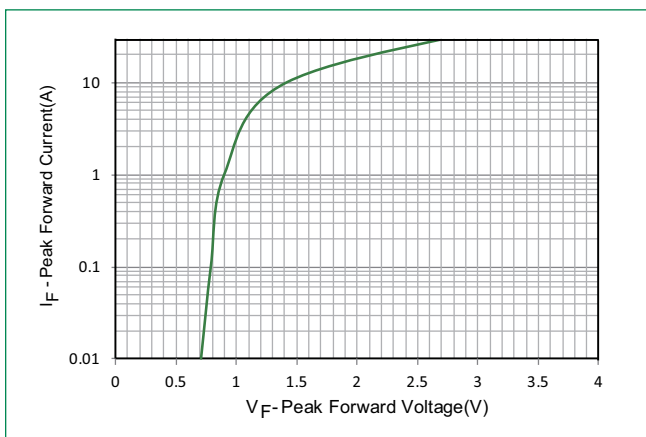
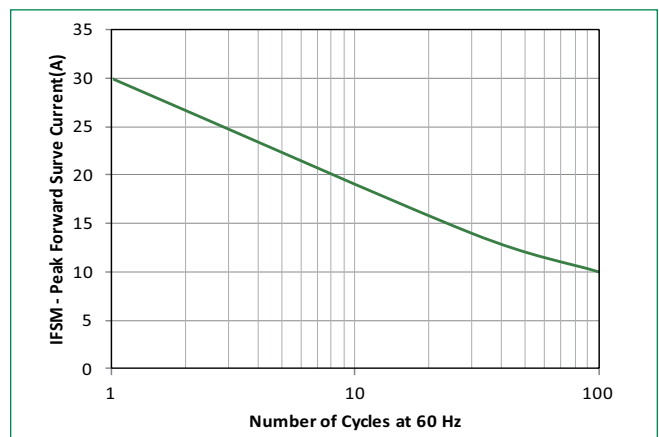

Figure 8: Maximum Non-Repetitive Forward Surge Current Uni-Directional Only



SMF Series

Surface Mount – 200W

Soldering Parameters

Reflow Condition		Lead-free assembly
Pre Heat	- Temperature Min ($T_{s(min)}$)	150°C
	- Temperature Max ($T_{s(max)}$)	200°C
	- Time (min to max) (t_s)	60 – 120 secs
Average ramp up rate (Liquidus Temp (T_L) to peak)		3°C/second max
$T_{s(max)}$ to T_L - Ramp-up Rate		3°C/second max
Reflow	- Temperature (T_L) (Liquidus)	217°C
	- Time (min to max) (t_L)	60 – 150 seconds
Peak Temperature (T_p)		260 ^{+0/-5} °C
Time within 5°C of actual peak Temperature (t_p)		30 Seconds Max
Ramp-down Rate		6°C/second Max
Time 25°C to peak Temperature (T_p)		8 minutes Max.
Do not exceed		260°C

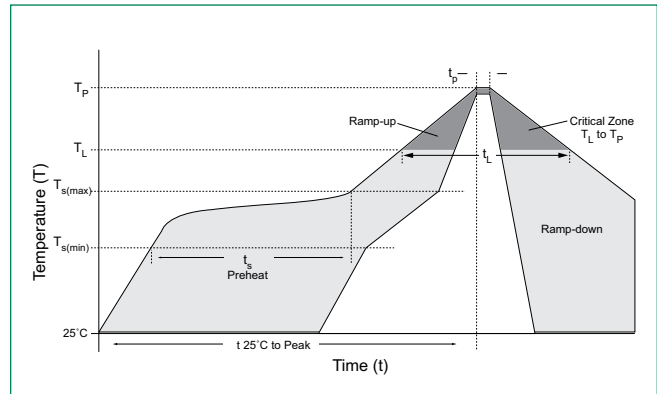

Physical Specifications

Case	SOD-123FL plastic over glass passivated junction
Polarity	Color band denotes cathode except bipolar
Terminal	Matte tin-plated leads, solderable per JESD22-B102

Environmental Specifications

High Temp. Storage	JESD22-A103
HTRB	JESD22-A108
Temperature Cycling	JESD22-A104
MSL	JEDEC-J-STD-020, Level 1
H3TRB	JESD22-A101
RSH	JESD22-A111

Dimensions - SOD-123FL Package

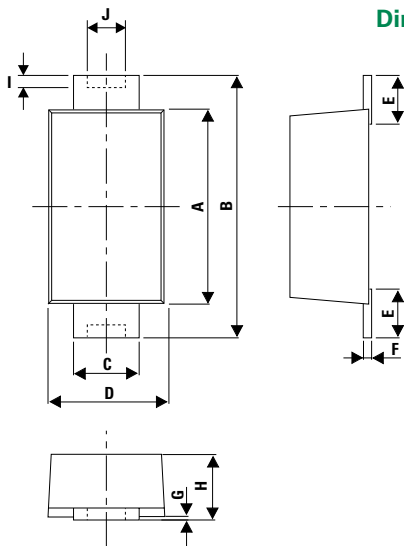

Mounting Pad Layout

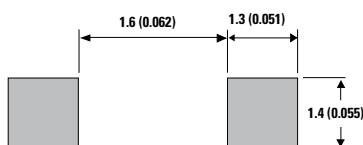

Dimensions	Millimeters		Inches	
	Min	Max	Min	Max
A	2.50	3.10	0.0984	0.1220
B	3.40	3.90	0.1339	0.1535
C	0.70	1.20	0.0275	0.0472
D	1.50	2.00	0.0591	0.0787
E	0.35	0.90	0.0138	0.0354
F	0.05	0.26	0.0020	0.0102
G	0.00	0.10	0.000	0.0039
H	0.90	1.10	0.0354	0.0433
I	0.00	0.20	0.000	0.008
J	0.40	0.60	0.016	0.024

SMF Series

Surface Mount – 200W

Part Numbering System

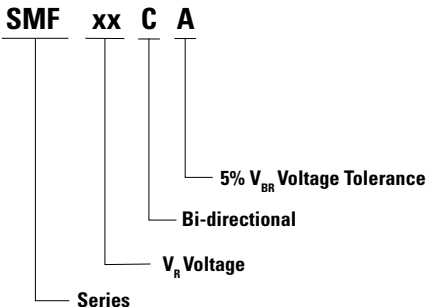

Part Marking System

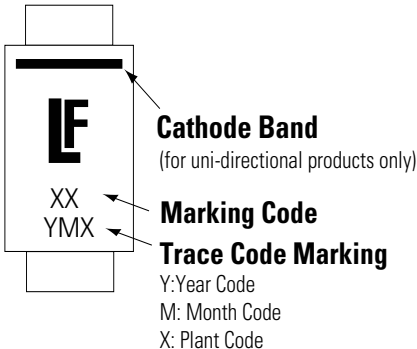

Packaging Options

Part number	Component Package	Quantity	Packaging Option	Packaging Specification
SMFXXX	SOD-123FL	3000	Tape & Reel – 8mm tape/7" reel	EIA RS-481
SMFXXX-T13	SOD-123FL	10000	Tape & Reel – 8mm tape/13" reel	EIA RS-481

Tape and Reel Specification

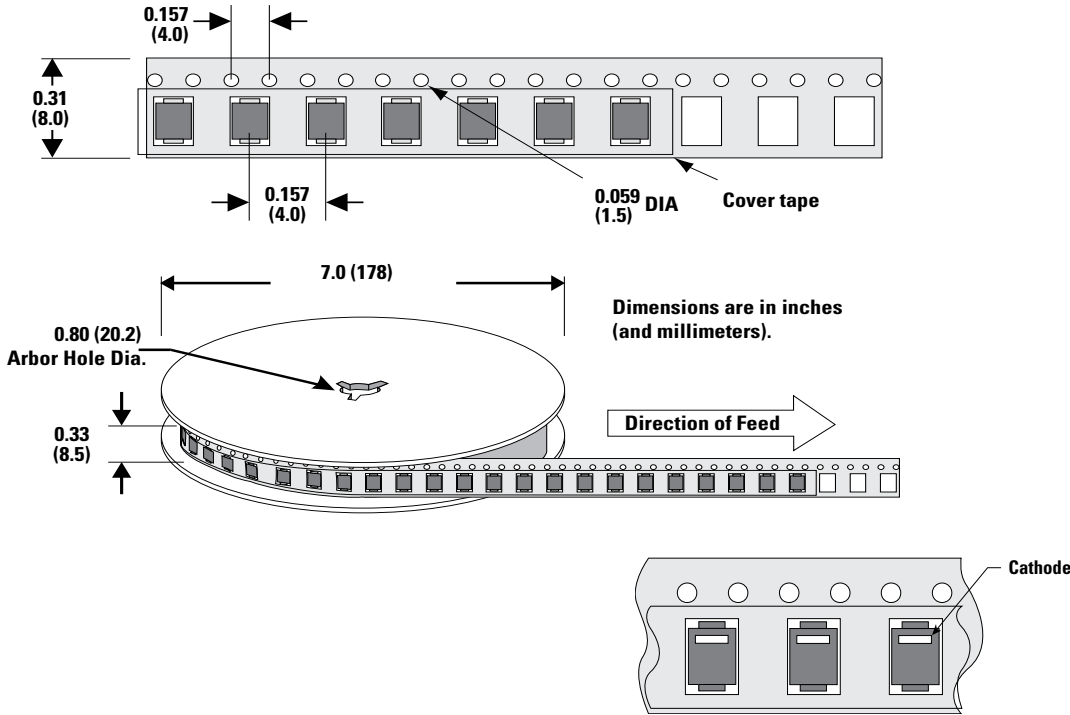

Disclaimer Notice - Information furnished is believed to be accurate and reliable. However, users should independently evaluate the suitability of and test each product selected for their own applications. Littelfuse products are not designed for, and may not be used in, all applications. Read complete Disclaimer Notice at www.littelfuse.com/disclaimer-electronics.