

SC7538-08UTG

0.3pF Diode Array, Low Capacitance ESD Protection

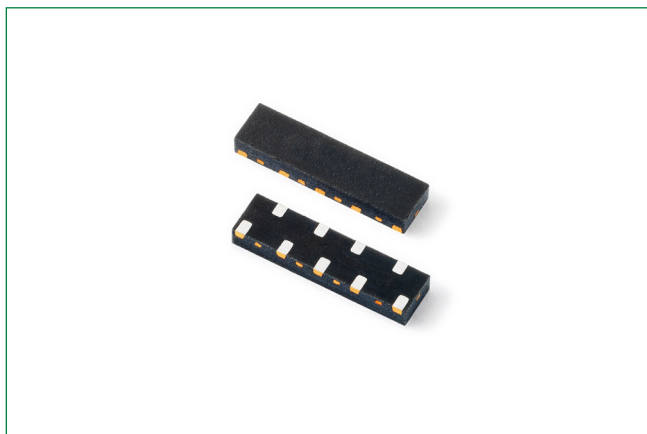

Note: This package image is for example and reference only. For detail package drawing, please refer to the package section in this datasheet.

Pinout

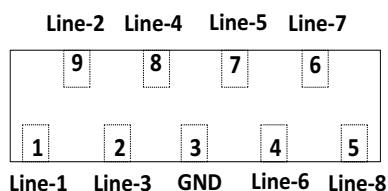

Top View

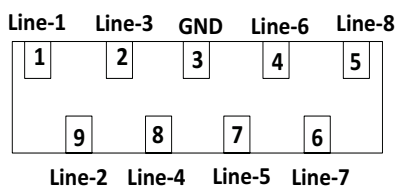

Bottom View

Functional Block Diagram

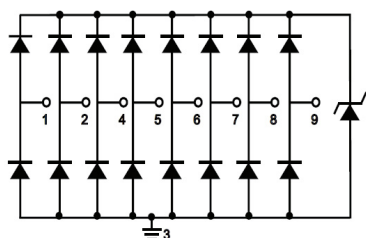

Description

The SC7538 integrates 8 channels of ultra low capacitance rail-to-rail diodes and an additional zener diode to provide protection for electronic equipment that may experience destructive electrostatic discharges (ESD). This robust device can safely absorb repetitive ESD strikes above the maximum level maximum level, $\pm 8\text{kV}$ contact discharge, as specified in the international standard IEC 61000-4-2, without performance degradation standard ($\pm 8\text{kV}$ contact discharge) without performance degradation. The extremely low loading capacitance also makes it ideal for protecting high speed signal pins such as V-By-One, HDMI, USB3.0, USB2.0, and IEEE 1394.

Features & Benefits

- ESD, IEC 61000-4-2, $\pm 22\text{kV}$ contact, $\pm 30\text{kV}$ air
- EFT, IEC 61000-4-4, 40A ($t_p=5/50\text{ns}$)
- Surge Tolerance, IEC 61000-4-5 2nd edition, 3A ($t_p=8/20\mu\text{s}$)
- Low capacitance of 0.3pF @0V, 3GHz (TYP) per I/O
- Low leakage current of 0.5 μA (MAX) at 5V
- Halogen free, Lead free and RoHS compliant

Applications

- V-By-One
- Embedded DisplayPort
- USB 2.0/3.0 Ports
- HDMI
- Flat Panel Displays
- LCD/LED TVs
- Smartphones
- Mobile Computing

Life Support Note:

Not Intended for Use in Life Support or Life Saving Applications
The products shown herein are not designed for use in life sustaining or life saving applications unless otherwise expressly indicated.

SC7538-08UTG

0.3pF Diode Array, Low Capacitance ESD Protection

Absolute Maximum Ratings

Symbol	Parameter	Value	Units
I_{PP}	Peak Current ($t_p=8/20\mu s$)	3.0	A
T_{OP}	Operating Temperature	-40 to 125	°C
T_{STOR}	Storage Temperature	-55 to 150	°C

Caution: Stresses above those listed in "Absolute Maximum Ratings" may cause permanent damage to the component. This is a stress only rating and operation of the component at these or any other conditions above those indicated in the operational sections of this specification is not implied.

Electrical Characteristics ($T_{OP}=25^\circ C$)

Parameter	Symbol	Test Conditions	Min	Typ	Max	Units
Reverse Standoff Voltage	V_{RWM}	Pin-1,-2,-4,-5,-6,-7,-8,-9 to pin-3			5	V
Breakdown Voltage	V_{BR}	$I_R=1\text{ mA}$	6			V
Reverse Leakage Current	I_{LEAK}	$V_R=5\text{V}$, I/O to GND			0.5	μA
Clamp Voltage ¹	V_C	$I_{PP}=1\text{A}$, $t_p=8/20\mu s$, Fwd		9.9		V
		$I_{PP}=2\text{A}$, $t_p=8/20\mu s$, Fwd		10.9		
Dynamic Resistance ²	R_{DYN}	TLP, $t_p=100\text{ns}$, I/O to GND		0.42		Ω
ESD Withstand Voltage ^{1,3}	V_{ESD}	IEC 61000-4-2 (Contact Discharge)	± 22			kV
		IEC 61000-4-2 (Air Discharge)	± 30			kV
Diode Capacitance ¹	$C_{I/O-GND}$	Reverse Bias=0V, $f=3\text{GHz}$		0.3		pF

Notes:

- Parameter is guaranteed by design and/or component characterization.
- Transmission Line Pulse (TLP) test setting: Std.TDR(50 Ω), $t_p=100\text{ns}$, $t_r=0.2\text{ns}$ ITLP and VTLP averaging window: start $t_1=70\text{ns}$ to end $t_2=90\text{ns}$
- Device stressed with ten non-repetitive ESD pulses.

8/20 μs Pulse Waveform

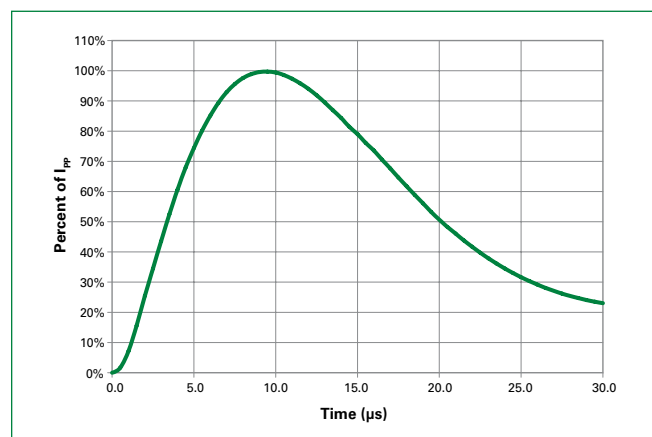

Clamping Voltage vs IPP

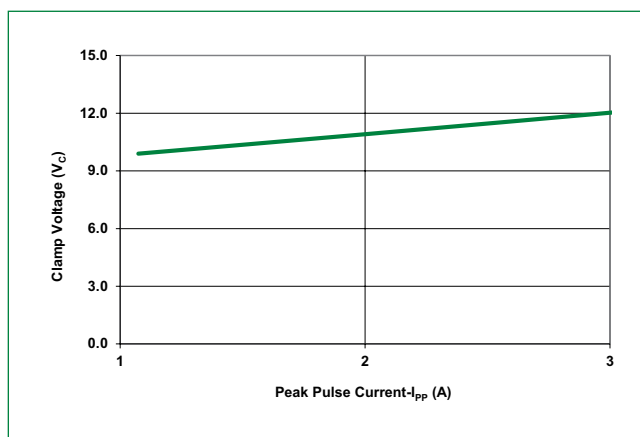

SC7538-08UTG

0.3pF Diode Array, Low Capacitance ESD Protection

Positive Transmission Line Pulsing (TLP) Plot

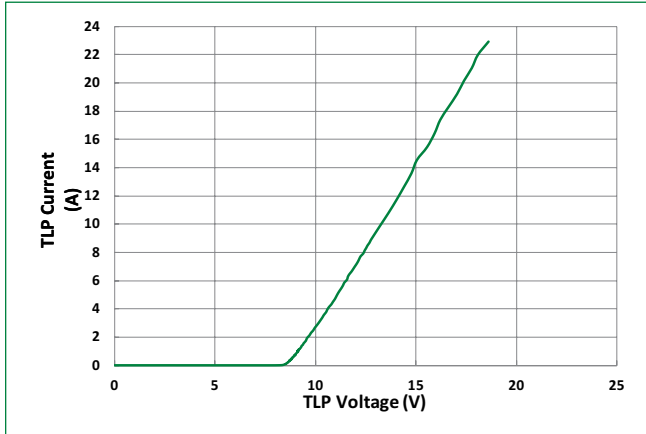

Negative Transmission Line Pulsing (TLP) Plot

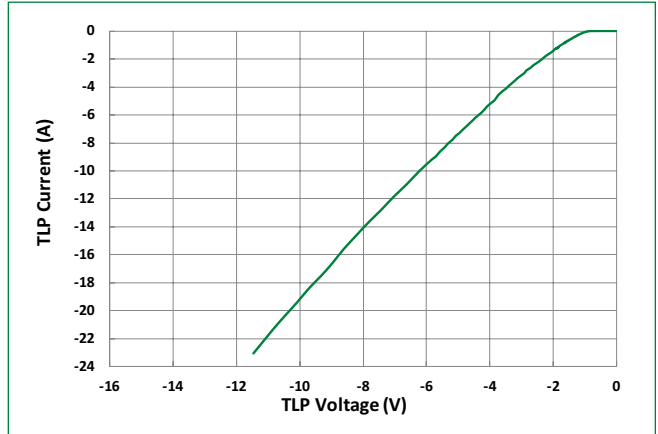

IEC 61000-4-2 +8 kV Contact ESD Clamping Voltage

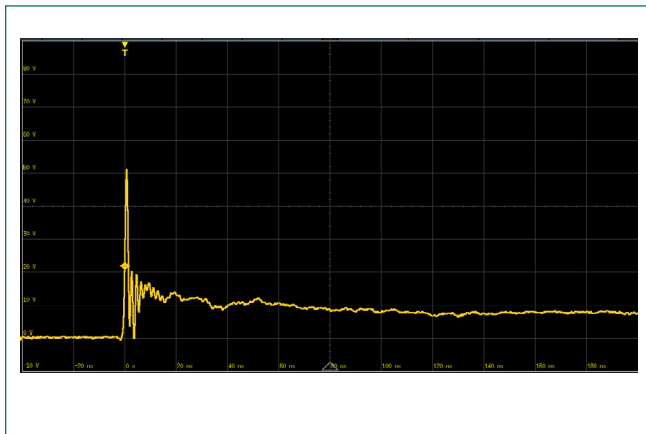

IEC 61000-4-2 -8 kV Contact ESD Clamping Voltage

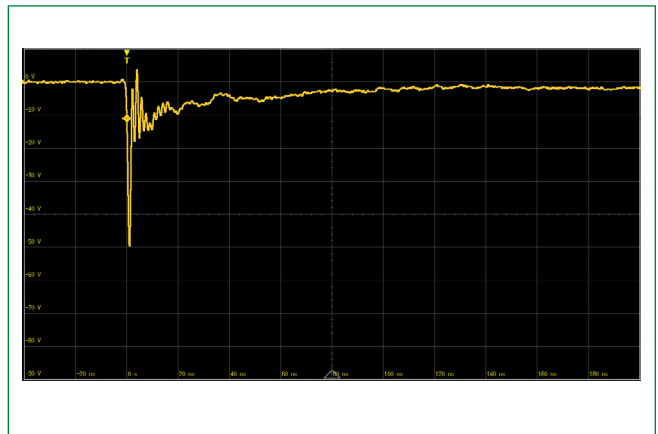

SC7538-08UTG

0.3pF Diode Array, Low Capacitance ESD Protection

Soldering Parameters

Reflow Condition		Pb – Free assembly
Pre Heat	- Temperature Min ($T_{s(min)}$)	150°C
	- Temperature Max ($T_{s(max)}$)	200°C
	- Time (min to max) (t_s)	60 – 120 secs
Average ramp up rate (Liquidus) Temp (T_L) to peak		3°C/second max
$T_{s(max)}$ to T_L - Ramp-up Rate		3°C/second max
Reflow	- Temperature (T_L) (Liquidus)	217°C
	- Temperature (t_L)	60 – 150 seconds
Peak Temperature (T_p)		260 ^{+0/-5} °C
Time within 5°C of actual peak Temperature (t_p)		30 seconds
Ramp-down Rate		6°C/second max
Time 25°C to peak Temperature (T_p)		8 minutes Max.
Do not exceed		260°C

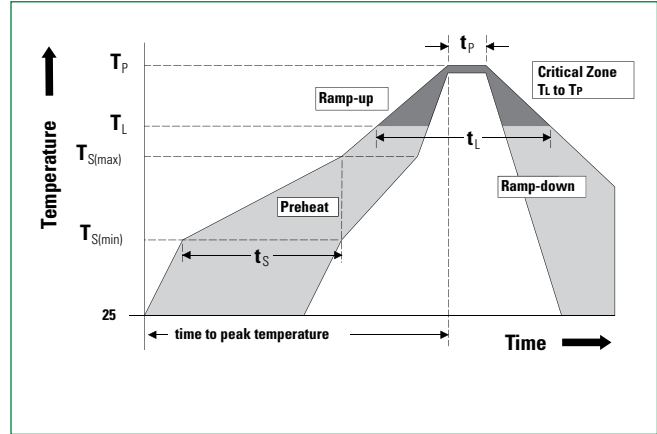

Ordering Information

Part Number	Package	Min. Order Qty.
SC7538-08UTG	μDFN-9	3000

Product Characteristics

Lead Plating	Matte Tin
Lead material	Copper Alloy
Substrate Material	Silicon
Body Material	Molded Compound
Flammability	UL Recognized compound meeting flammability rating V-0

Part Marking System

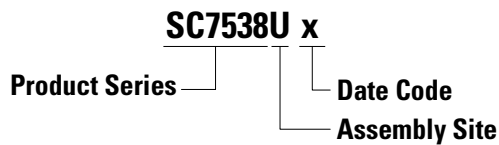

Part Numbering System

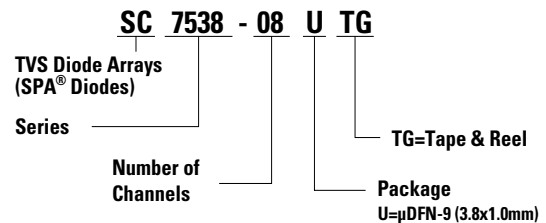

SC7538-08UTG

0.3pF Diode Array, Low Capacitance ESD Protection

Package Dimensions

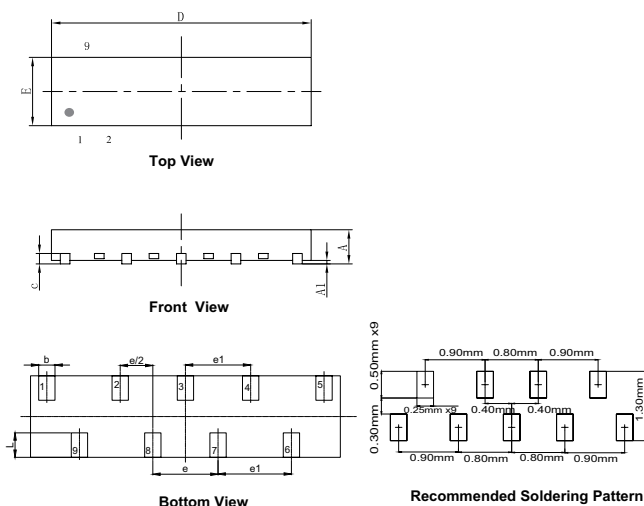

μ DFN-9 (3.8x1.0mm)						
Symbol	Millimeters			Inches		
	Min	Nom	Max	Min	Nom	Max
A	0.45	0.50	0.55	0.018	0.020	0.022
A1	-	0.02	0.05	-	0.001	0.002
b	0.15	0.20	0.25	0.006	0.008	0.010
c	0.10	0.15	0.20	0.004	0.006	0.008
D	3.70	3.80	3.90	0.146	0.150	0.154
e	0.80 BSC			0.031 BSC		
e1	0.90 BSC			0.035 BSC		
E	0.90	1.00	1.10	0.035	0.039	0.043
L	0.20	0.30	0.40	0.008	0.012	0.016

Embossed Carrier Tape & Reel Specification

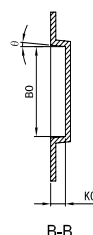
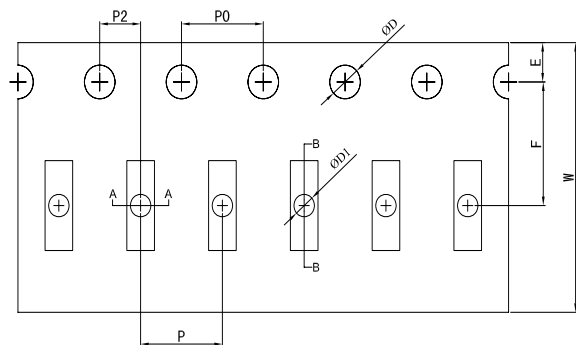

Symbol	Millimeters
A0	1.35 +/- 0.10
B0	4.00 +/- 0.05
D	\varnothing 1.50 + 0.1/- 0
D1	\varnothing 1.00 +/- 0.05
E	1.75 +/- 0.10
F	5.50 +/- 0.05
KO	0.72 +/- 0.05
P	4.00 +/- 0.10
P0	4.00 +/- 0.10
P2	2.00 +/- 0.05
T	0.25 +/- 0.02
W	12.00 + 0.30/- 0.10

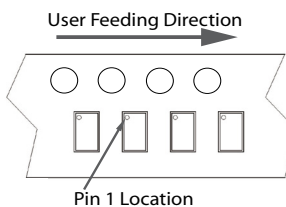
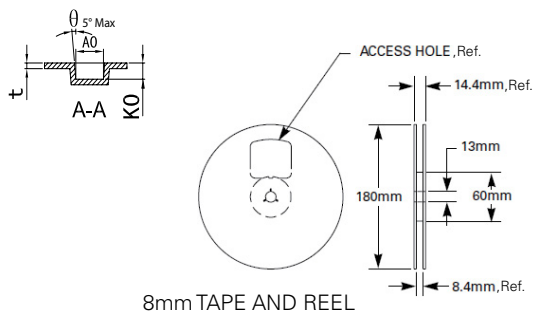

Product Disclaimer: Littelfuse products are not designed for, and shall not be used for, any purpose (including, without limitation, automotive, military, aerospace, medical, life-saving, life-sustaining or nuclear facility applications, devices intended for surgical implant into the body, or any other application in which the failure or lack of desired operation of the product may result in personal injury, death, or property damage) other than those expressly set forth in applicable Littelfuse product documentation. Warranties granted by Littelfuse shall be deemed void for products used for any purpose not expressly set forth in applicable Littelfuse documentation. Littelfuse shall not be liable for any claims or damages arising out of products used in applications not expressly intended by Littelfuse as set forth in applicable Littelfuse documentation. The sale and use of Littelfuse products is subject to Littelfuse Terms and Conditions of Sale, unless otherwise agreed by Littelfuse. "Littelfuse" includes Littelfuse, Inc., and all of its affiliate entities. <http://www.littelfuse.com/disclaimer-electronics>

SC7538-08UTG

0.3pF Diode Array, Low Capacitance ESD Protection

Product Disclaimer: Littelfuse products are not designed for, and shall not be used for, any purpose (including, without limitation, automotive, military, aerospace, medical, life-saving, life-sustaining or nuclear facility applications, devices intended for surgical implant into the body, or any other application in which the failure or lack of desired operation of the product may result in personal injury, death, or property damage) other than those expressly set forth in applicable Littelfuse product documentation. Warranties granted by Littelfuse shall be deemed void for products used for any purpose not expressly set forth in applicable Littelfuse documentation. Littelfuse shall not be liable for any claims or damages arising out of products used in applications not expressly intended by Littelfuse as set forth in applicable Littelfuse documentation. The sale and use of Littelfuse products is subject to Littelfuse Terms and Conditions of Sale, unless otherwise agreed by Littelfuse. "Littelfuse" includes Littelfuse, Inc., and all of its affiliate entities. <http://www.littelfuse.com/disclaimer-electronics>.