

SJxx08xSx and SJxx08xx Series

8 A High Temperature Sensitive and Standard SCRs

HF RoHS

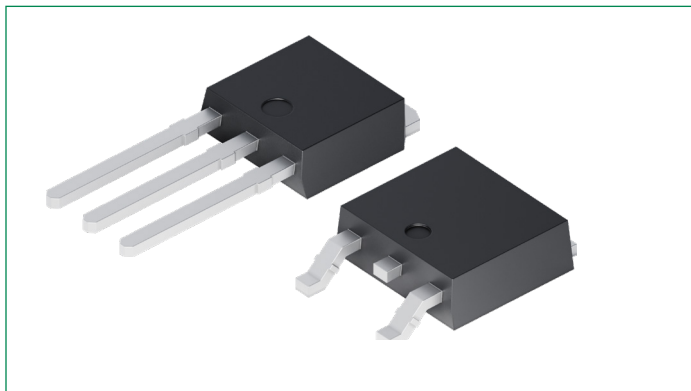

Description

The SJxx080xx high temperature SCR series is ideal for uni-directional switch applications such as phase control in heating, motor speed controls, converters/rectifiers, and capacitive discharge ignitions.

These SCRs have a low gate current trigger level of 6 mA or 15 mA maximum at approximately 1.5 V gate trigger voltage, with a sensitive version of this series having a gate trigger current less than 200 μ A. The sensitive gate SCR version is easily triggered by sense coils, proximity switches, and microprocessors.

Features

- Voltage capability up to 800 V
- Surge current capability up to 100 A at 60 Hz half cycle
- Maximum $T_{vj(max)}$ of 150 °C

Applications

Typical applications include capacitive discharge system for motorcycle engine CDI, portable generator engine ignition, strobe lights, and nailers. These devices are also suitable for applications such as generic rectifiers, battery voltage regulators and converters, controls for power tools, home/brown goods, and white goods appliances.

Product Summary

Characteristic	Value	Unit
$I_{T(RMS)}$	8	A
V_{DRM}/V_{RRM}	400 or 600 or 800	V
I_{GT}	0.2 to 15	mA

Pinout Diagram

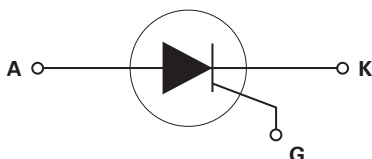
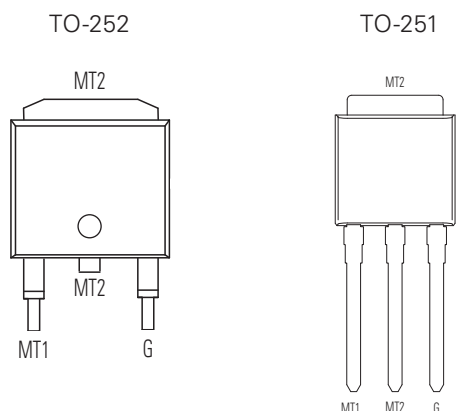

K: Cathode; **A:** Anode; **G:** Gate

Maximum Ratings – Sensitive SCRs

Symbol	Characteristics	Conditions	Value	Units	
$I_{T(RMS)}$	On-state RMS Current	$T_C = 120\text{ }^\circ\text{C}$	8	A	
$I_{T(AV)}$	Average On-state Current	$T_C = 120\text{ }^\circ\text{C}$	5.1	A	
I_{TSM}	Non-repetitive Surge Peak On-state Current	f = 50 Hz	single half cycle,	83	A
		f = 60 Hz	T_{vj} (initial) = 25 °C	100	
I^2t	I^2t Value for Fusing	$t_p = 8.3\text{ ms}$	41	A ² s	
di/dt	Critical Rate of Rise of On-state Current	f = 60 Hz, $T_{vj} = 150\text{ }^\circ\text{C}$	70	A/ μs	
I_{GM}	Peak Gate Current	$P_W = 20\text{ }\mu\text{s}$, $T_{vj} = 150\text{ }^\circ\text{C}$	0.5	A	
$P_{G(AV)}$	Average Gate Power Dissipation	$T_{vj} = 150\text{ }^\circ\text{C}$	0.1	W	
T_{stg}	Storage Temperature Range	–	–40 to 150	°C	
T_{vj}	Virtual Junction Temperature Range	–	–40 to 150	°C	
V_{DSM}/V_{RSM}	Non-repetitive Surge Peak Off-state Voltage	$P_W = 100\text{ }\mu\text{s}$	$V_{DRM}/V_{RRM} + 100$	V	

Maximum Ratings— Standard SCRs

Symbol	Characteristics	Conditions	Value	Units	
$I_{T(RMS)}$	On-state RMS Current	$T_C = 125\text{ }^\circ\text{C}$	8	A	
$I_{T(AV)}$	Average On-state Current	$T_C = 125\text{ }^\circ\text{C}$	5.1	A	
I_{TSM}	Non-repetitive Surge Peak On-state Current	f = 50 Hz	single half cycle,	83	A
		f = 60 Hz	T_{vj} (initial) = 25 °C	100	
I^2t	I^2t Value for Fusing	$t_p = 8.3\text{ ms}$	41	A ² s	
di/dt	Critical Rate of Rise of On-state Current	f = 60 Hz, $T_{vj} = 150\text{ }^\circ\text{C}$	100	A/ μs	
I_{GM}	Peak Gate Current	$P_W = 20\text{ }\mu\text{s}$, $T_{vj} = 150\text{ }^\circ\text{C}$	0.5	A	
$P_{G(AV)}$	Average Gate Power Dissipation	$T_{vj} = 150\text{ }^\circ\text{C}$	0.1	W	
T_{stg}	Storage Temperature Range	–	–40 to 150	°C	
T_{vj}	Virtual Junction Temperature Range	–	–40 to 150	°C	
V_{DSM}/V_{RSM}	Non-repetitive Surge Peak Off-state Voltage	$P_W = 100\text{ }\mu\text{s}$	400–600 V	$V_{DRM}/V_{RRM} + 100$	V
			800 V	$V_{DRM}/V_{RRM} + 200$	

Electrical Characteristics ($T_{vj} = 25\text{ }^\circ\text{C}$, unless otherwise specified) – Sensitive SCRs

Symbol	Characteristics	Conditions	SJxx08xS2			Units
			Min.	Typ.	Max.	
I_{GT}	DC Gate Trigger Current	$V_D = 6\text{ V}$, $R_L = 100\text{ }\Omega$	20	–	200	μA
V_{GT}	DC Gate Trigger Voltage	$V_D = 6\text{ V}$, $R_L = 100\text{ }\Omega$	–	–	0.8	V
dv/dt	Rate of Rise of Off-stage Voltage	$V_D = V_{DRM}$, $R_{GK} = 220\text{ }\Omega$, $T_{vj} = 125\text{ }^\circ\text{C}$	15	–	–	V/ μs
V_{GD}	Gate Non-trigger Voltage	$V_D = V_{DRM}$, $R_L = 3.3\text{ k}\Omega$, $T_{vj} = 125\text{ }^\circ\text{C}$	0.2	–	–	V
		$V_D = V_{DRM}$, $R_L = 3.3\text{ k}\Omega$, $T_{vj} = 150\text{ }^\circ\text{C}$	0.1	–	–	
V_{RGM}	Peak Reverse Gate Voltage	$I_{GR} = 10\text{ }\mu\text{A}$	6	–	–	V
I_H	Holding Current	$I_T = 200\text{ mA}$ (initial)	–	–	6	mA
t_q	Turn-off Time	$t_p = 50\text{ }\mu\text{s}$, $dv/dt = 5\text{ V}/\mu\text{s}$, $di/dt = -30\text{ A}/\mu\text{s}$	–	–	130	μs
t_{gt}	Turn-on Time	$I_G = 2 \times I_{GT}$, $P_W = 15\text{ }\mu\text{s}$, $I_T = 8\text{ A}$	–	6	–	μs

xx = voltage

Electrical Characteristics ($T_{vj} = 25\text{ }^\circ\text{C}$, unless otherwise specified) — **Standard SCRs**

Symbol	Characteristics	Conditions	SJxx08x1			SJxx08x			Units
			Min.	Typ.	Max.	Min.	Typ.	Max.	
I_{GT}	DC Gate Trigger Current	$V_D = 12\text{ V}, R_L = 60\ \Omega$	–	–	6	–	–	15	mA
V_{GT}	DC Gate Trigger Voltage	$V_D = 12\text{ V}, R_L = 60\ \Omega$	–	–	1.5	–	–	1.5	V
dv/dt	Rate of Rise of Off-stage Voltage	$V_D = V_{DRM}, \text{ gate open}, T_{vj} = 125\text{ }^\circ\text{C}$	100	–	–	200	–	–	V/ μs
		$V_D = V_{DRM}, \text{ gate open}, T_{vj} = 150\text{ }^\circ\text{C}$	50	–	–	120	–	–	
V_{GD}	Gate Non-trigger Voltage	$V_D = V_{DRM}, R_L = 3.3\text{ k}\Omega, T_{vj} = 125\text{ }^\circ\text{C}$	0.2	–	–	0.2	–	–	V
		$V_D = V_{DRM}, R_L = 3.3\text{ k}\Omega, T_{vj} = 150\text{ }^\circ\text{C}$	0.15	–	–	0.15	–	–	
I_H	Holding Current	$I_T = 200\text{ mA (initial)}$	–	–	20	–	–	30	mA
t_q	Turn-off Time	$I_T = 0.5\text{ A}, t_p = 50\ \mu\text{s}, dv/dt = 5\text{ V}/\mu\text{s}, di/dt = -30\text{ A}/\mu\text{s}$	–	–	30	–	–	35	μs
t_{gt}	Turn-on Time	$I_G = 2 \times I_{GT}, P_W = 15\ \mu\text{s}, I_T = 8\text{ A}$	–	0.5	–	–	2	–	μs

xx = voltage

Thermal Characteristics

Symbol	Characteristics	Value	Units	
$R_{th(j-c)}$	Thermal Resistance, Junction to Case (AC)	SJxx08xS2	1.2	K/W
		SJxx08xx	1.2	

xx = voltage

Static Characteristics

Symbol	Characteristics	Conditions	Maximum Value	Units	
V_{TM}	Peak On-state Voltage	$I_T = 16\text{ A } t_p = 380\ \mu\text{s}$	1.6	V	
I_{DRM}/I_{RRM}	Peak Repetitive Off-state Current	SJxx08xS2	$T_{vj} = 25\text{ }^\circ\text{C}$	5	μA
			$T_{vj} = 125\text{ }^\circ\text{C}, R_{GK} = 220\ \Omega$	1000	
			$T_{vj} = 150\text{ }^\circ\text{C}, R_{GK} = 220\ \Omega$	3000	
		SJxx08xx	$T_{vj} = 25\text{ }^\circ\text{C}$	10	
			$T_{vj} = 125\text{ }^\circ\text{C}$	1000	
			$T_{vj} = 150\text{ }^\circ\text{C}$	3000	

xx = voltage

Characteristic Curves

Fig. 1. Normalized DC Gate Trigger Current vs. Junction Temperature (Sensitive SCR)

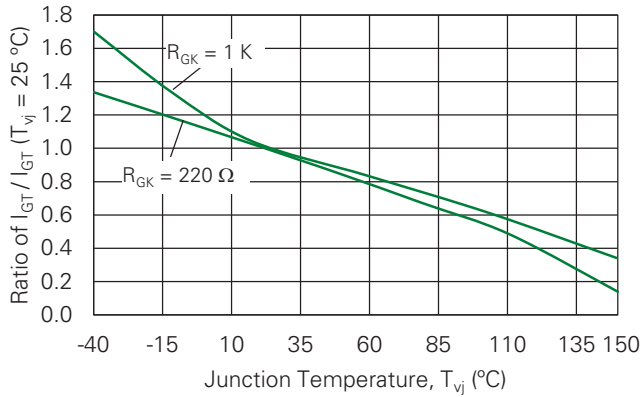

Fig. 2. Normalized DC Gate Trigger Current vs. Junction Temperature (Standard SCR)

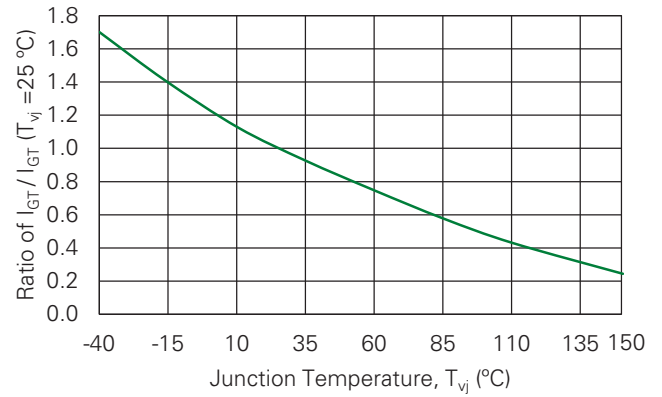

Fig. 3. Normalized DC Gate Trigger Voltage vs. Junction Temperature

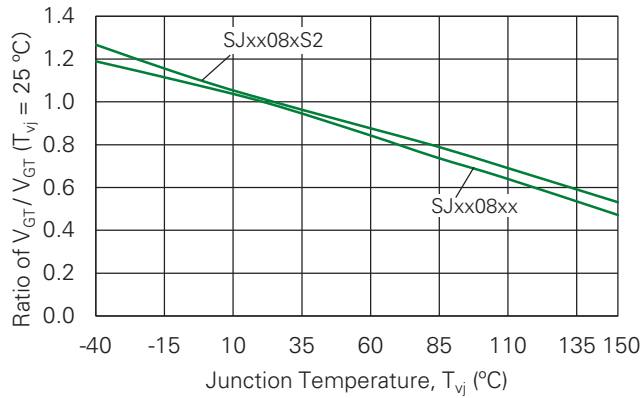

Fig. 4. Normalized DC Holding Current vs. Junction Temperature

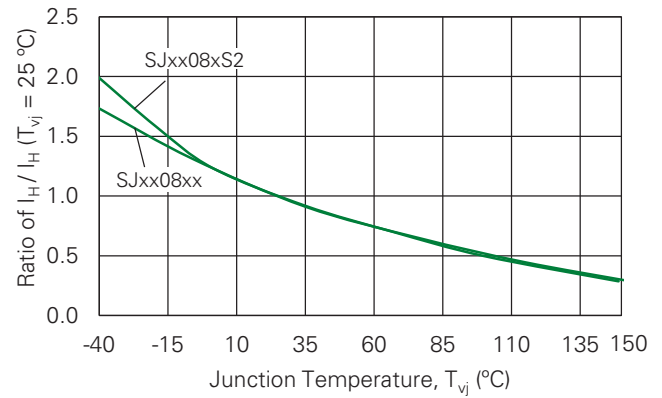

Fig. 5. Typical On-state Current vs. On-state Voltage

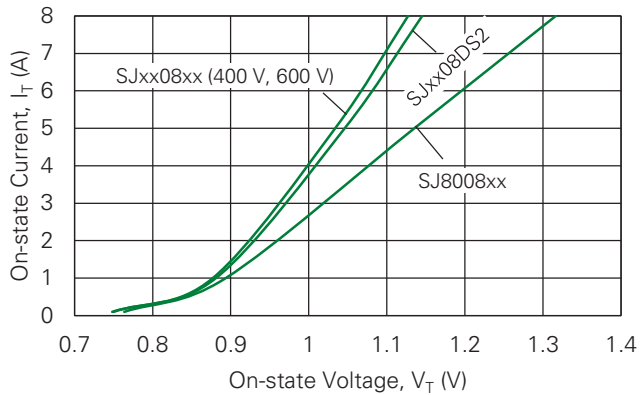

Fig. 6. Typical Power Dissipation vs. RMS On-state Current

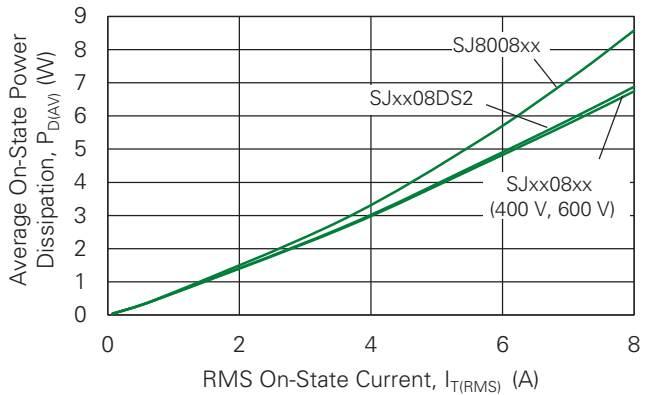

Fig. 7. Maximum Allowable Case Temperature vs. RMS On-state Current

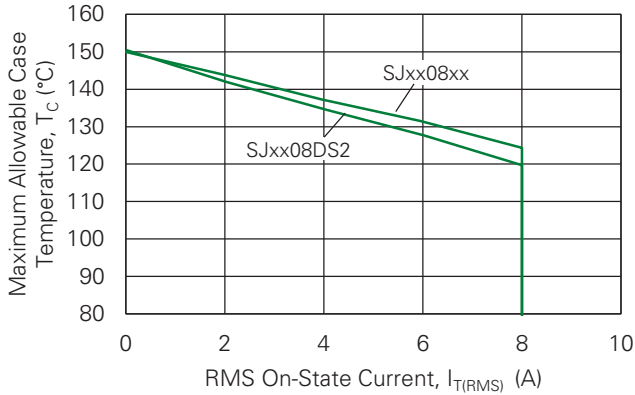

Fig. 8. Maximum Allowable Case Temperature vs. Average On-state Current

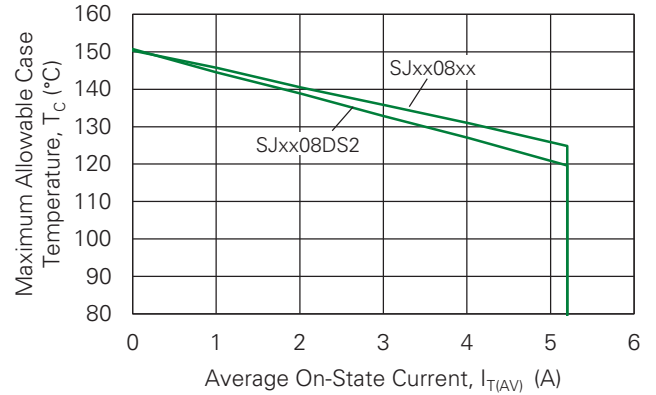

Fig. 9. Peak Capacitor Discharge Current

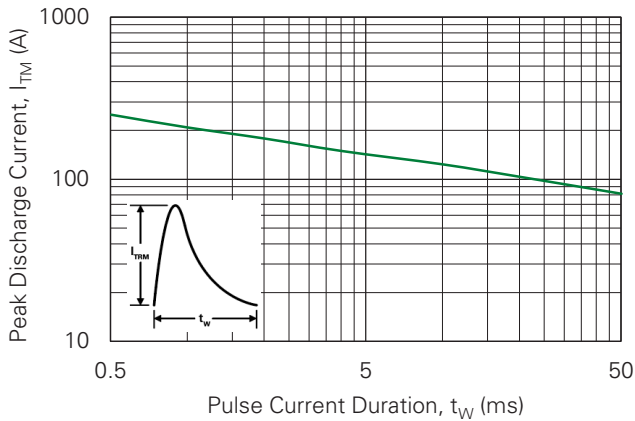
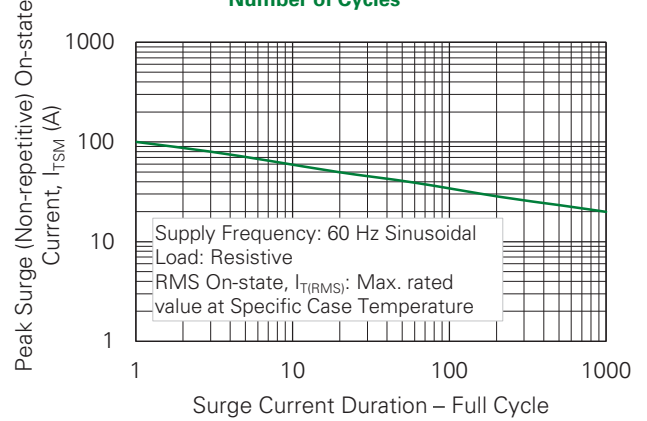

Fig. 10. Surge Peak On-state Current vs. Number of Cycles



Notes:

1. Gate control may be lost during and immediately following surge current interval.
2. Overload should not be repeated until junction temperature has returned to steady-state rated value.

Fig. 11. Typical DC Gate Trigger Current with R_{GK} vs. Junction Temperature (Sensitive SCR)

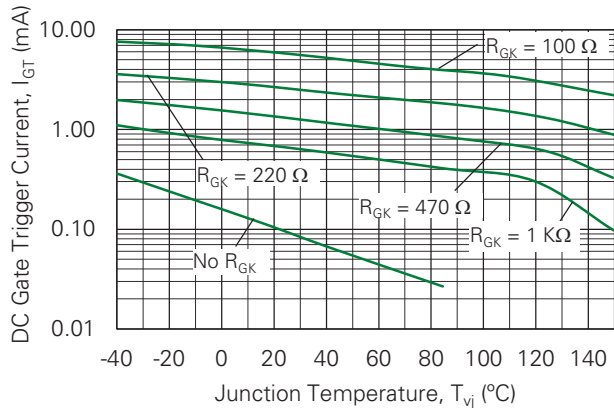

Fig. 12. Typical DC Holding Current with R_{GK} vs. Junction Temperature (Sensitive SCR)

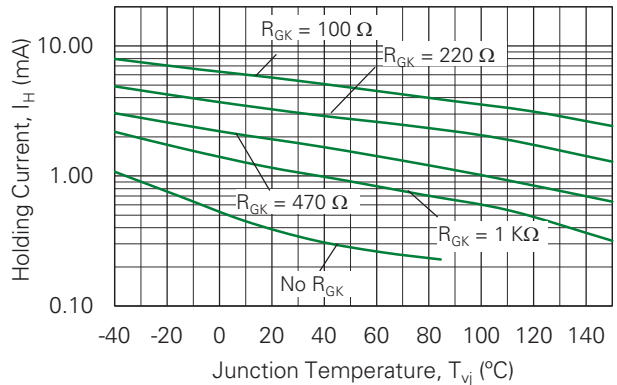
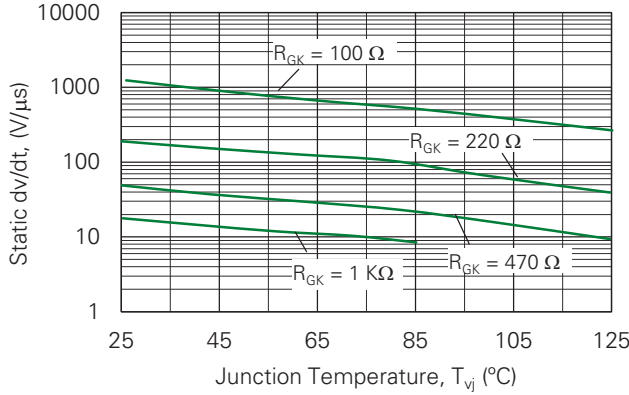

Fig. 13. Typical Static dv/dt with R_{GK} vs. Junction Temperature (Sensitive SCR)



Soldering Parameters

Characteristic		Value
Reflow Condition		Pb – Free assembly
Pre-heat	Temperature Min ($T_{s(min)}$)	150 °C
	Temperature Max ($T_{s(max)}$)	200 °C
	Time (min to max) (t_s)	60 – 120 secs
Average ramp up rate (Liquidus Temp)(T_L) to peak		3 °C/second max
$T_{s(max)}$ to T_L - Ramp-up Rate		3 °C/second max
Reflow	Temperature (T_L) (Liquidus)	217 °C
	Time (t_L)	60 – 150 seconds
Peak Temperature (T_p)		260 ^{+0/-5} °C
Time within 5°C of actual peak Temperature (t_p)		30 seconds max.
Ramp-down Rate		5°C/second max
Time 25°C to peak Temperature (T_p)		6 minutes max
Do Not Exceed		260 °C

Physical Specifications

Characteristic	Value
Terminal Finish	100% Matte Tin-plated
Body Material	UL Recognized compound meeting flammability rating V-0
Terminal Material	Copper Alloy

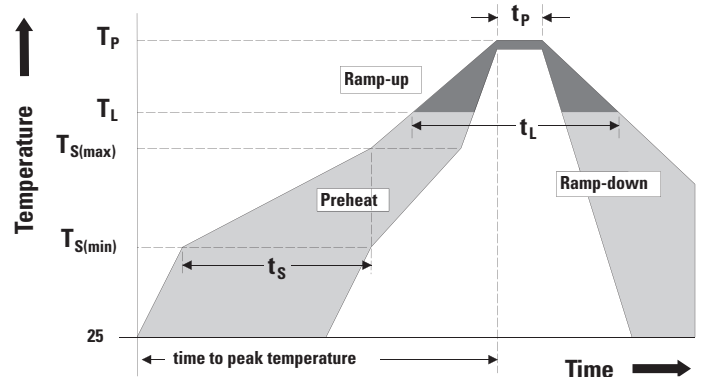

Environmental Specifications

Test	Specifications and Conditions
AC Blocking	MIL-STD-750, M-1040, Cond A Applied Peak AC voltage for 1008 hours
Temperature/Humidity	EIA / JEDEC, JESD22-A101, 1008 hours; 160 V - DC: 85 °C; 85% relative humidity
Temperature Cycling	MIL-STD-750, M-1051, 100 cycles; -40 °C to +150 °C; 15-min dwell-time
High Temperature Storage	MIL-STD-750 M-1031, 1008 hours, 150 °C
Low Temperature Storage	1008 hours, -40 °C
Resistance to Solder Heat	MIL-STD-750, Method 2031
Solderability	ANSI/J-STD-002: category 3, Test A
Lead Bend	MIL-STD-750, M-2036 Cond E
Moisture Sensitivity Level	Level 1, JEDEC-J-STD-020

Part Numbering and Marking

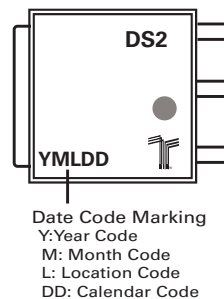
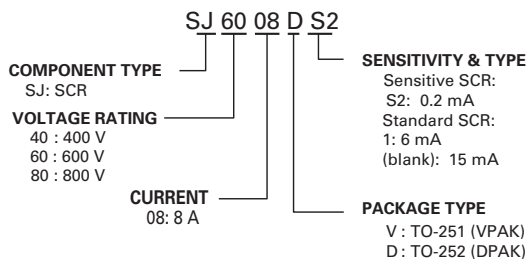

Packing Options

Part Number	Marking	Weight	Packing Mode	Base Quantity
SJxx08DS2TP	SJxx08DS2	0.3 g	Tube	750 (75 per tube)
SJxx08DS2RP	SJxx08DS2	0.3 g	Embossed Carrier	2500
SJxx08VS2TP	SJxx08VS2	0.4 g	Tube	750 (75 per tube)
SJxx08DTP	SJxx08D	0.3 g	Tube	750 (75 per tube)
SJxx08DRP	SJxx08D	0.3 g	Embossed Carrier	2500
SJxx08VTP	SJxx08V	0.4 g	Tube	750 (75 per tube)
SJxx08D1TP	SJxx08D1	0.3 g	Tube	750 (75 per tube)
SJxx08D1RP	SJxx08D1	0.3 g	Embossed Carrier	2500
SJxx08V1TP	SJxx08V1	0.4 g	Tube	750 (75 per tube)

xx = voltage

Product Selector

Part Number	Voltage			Gate Sensitivity Quadrants	Type	Package
	400 V	600 V	800 V	I-II-III		
SJxx08VS2	X	X	–	0.2 mA	Sensitive SCR	TO-251 (VPAK)
SJxx08DS2	X	X	–	0.2 mA	Sensitive SCR	TO-252 (DPAK)
SJxx08V	X	X	X	15 mA	Sensitive SCR	TO-251 (VPAK)
SJxx08D	X	X	X	15 mA	Sensitive SCR	TO-252 (DPAK)
SJxx08V1	X	X	–	6 mA	Sensitive SCR	TO-251 (VPAK)
SJxx08D1	X	X	–	6 mA	Sensitive SCR	TO-252 (DPAK)

xx = voltage

Package Dimensions TO-251AA (V Package) – VPAK Through Hole

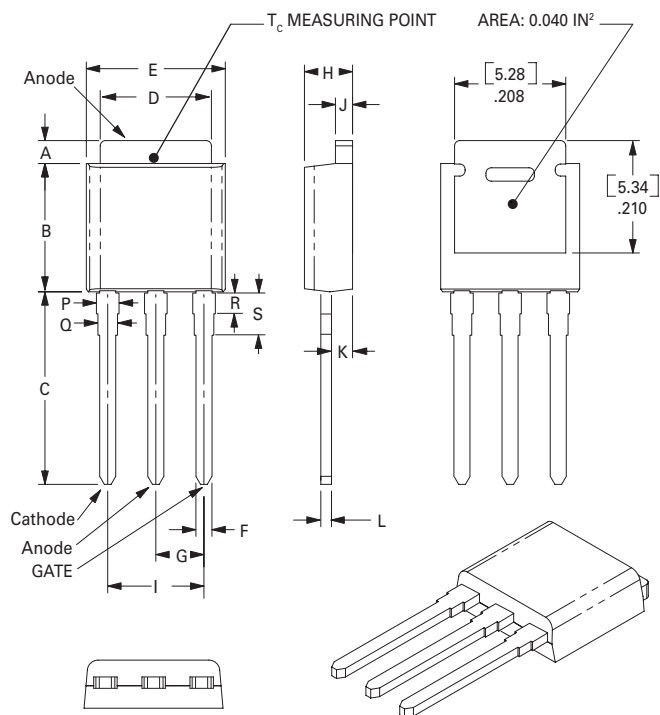

Symbol	Millimeters		Inches	
	Min.	Max.	Min.	Max.
A	0.94	1.09	0.037	0.043
B	5.97	6.22	0.235	0.245
C	8.89	9.53	0.350	0.375
D	5.21	5.41	0.205	0.213
E	6.48	6.73	0.255	0.265
F	0.69	0.84	0.027	0.033
G	2.21	2.36	0.087	0.093
H	2.16	2.41	0.085	0.095
I	4.47	4.67	0.176	0.184
J	0.46	0.58	0.018	0.023
K	0.90	1.00	0.035	0.039
L	0.46	0.58	0.018	0.023
P	1.06	1.32	0.042	0.052
Q	0.86	1.11	0.034	0.044
R	0.86	1.11	0.034	0.044
S	1.86	2.11	0.074	0.084

Package Dimensions TO-252AA (D Package) – DPAK Surface Mount

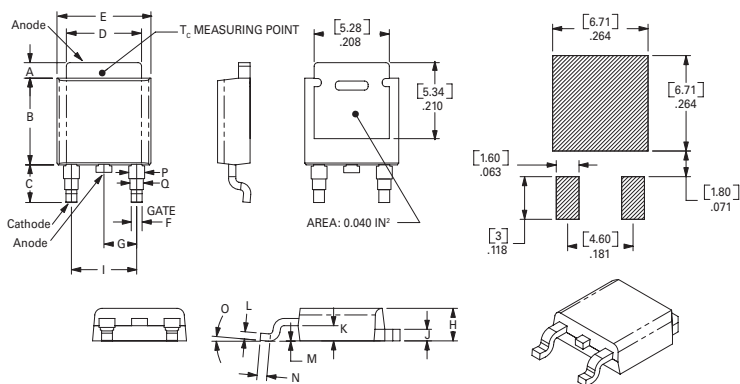

Symbol	Millimeters		Inches	
	Min.	Max.	Min.	Max.
A	0.94	1.09	0.037	0.043
B	5.97	6.22	0.235	0.245
C	2.69	2.87	0.106	0.113
D	5.21	5.41	0.205	0.213
E	6.48	6.73	0.255	0.265
F	0.69	0.84	0.027	0.033
G	2.21	2.36	0.087	0.093
H	2.16	2.41	0.085	0.095
I	4.47	4.67	0.176	0.184
J	0.46	0.58	0.018	0.023
K	0.90	1.00	0.035	0.039
L	0.46	0.58	0.018	0.023
M	0.00	0.10	0.000	0.004
N	0.53	0.69	0.021	0.027
O	0°	5°	0°	5°
P	1.06	1.32	0.042	0.052
Q	0.86	1.11	0.034	0.044

Reel Pack (RP) Specifications (TO-252 Embossed Carrier)

Meets all EIA-481-2 Standards

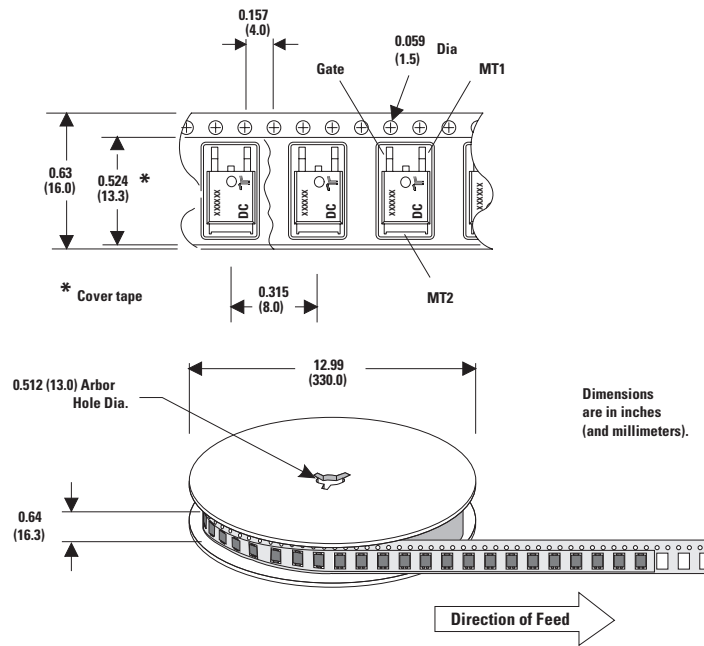

Disclaimer Notice

Information furnished is believed to be accurate and reliable. However, users should independently evaluate the suitability of and test each product selected for their own applications. Littelfuse products are not designed for, and may not be used in, all applications. Read complete Disclaimer Notice at <http://www.littelfuse.com/disclaimer-electronics>.



Part of:

