

T2500D

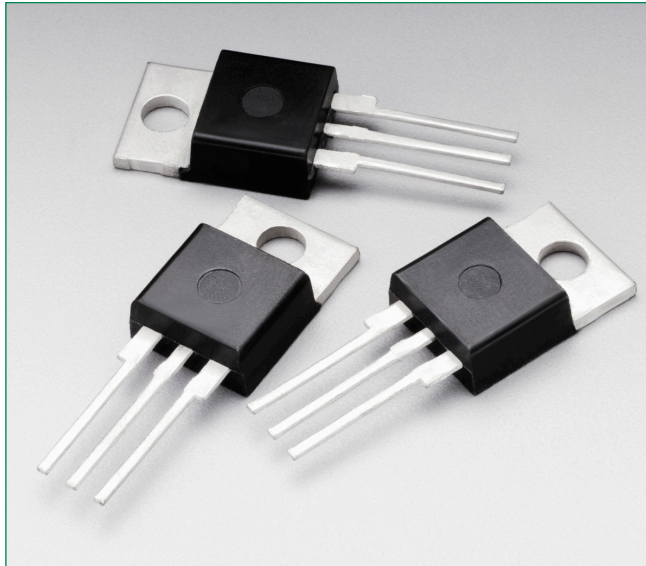

Description

Designed primarily for full-wave ac control applications, such as light dimmers, motor controls, heating controls and power supplies.

Features

- Blocking Voltage 400 V
- All Diffused and Glass Passivated Junctions for Greater Parameter Uniformity and Stability
- Small, Rugged, Thermowatt Construction for Low Thermal Resistance, High Heat Dissipation and Durability
- High Surge Current Capability 60 A Peak at $T_c = 80^\circ\text{C}$
- Pb-Free Package is Available

Pin Out

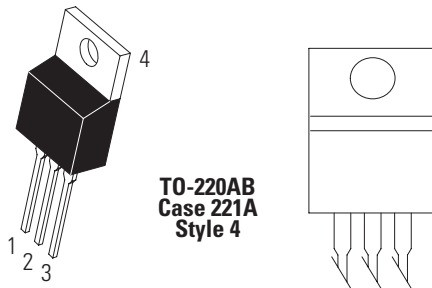

Functional Diagram

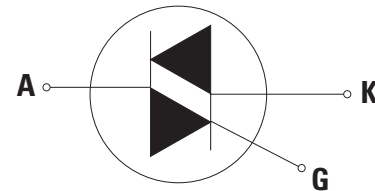

Additional Information



Datasheet



Resources



Samples

Maximum Ratings ($T_J = 25^\circ\text{C}$ unless otherwise noted)

Rating	Symbol	Value	Unit
Peak Repetitive Off-State Voltage (Note 1) (Sine Wave 50 to 60 Hz, $T_J = -40$ to $+100^\circ\text{C}$, Gate Open)	V_{DRM}^* V_{RRM}	400	V
On-State RMS Current (Full Cycle Sine Wave 50 to 60 Hz) ($T_C = +80^\circ\text{C}$)	$I_{\text{T (RMS)}}$	6.0	A
Peak Non-Repetitive Surge Current (One Full Cycle, Sine Wave 60 Hz, $T_C = +80^\circ\text{C}$)	I_{TSM}	60	A
Circuit Fusing Considerations ($t = 8.3$ ms)	I^2t	15	A ² s
Peak Gate Power (Pulse Width = 10 μsec , $T_C = +80^\circ\text{C}$)	P_{GM}	16	W
Average Gate Power ($t = 8.3$ msec, $T_C = +80^\circ\text{C}$)	$P_{\text{GM (AV)}}$	0.2	W
Peak Gate Current (Pulse Width = 10 μsec)	I_{GM}	4.0	A
Operating Junction Temperature Range	T_J	-40 to +125	$^\circ\text{C}$
Storage Temperature Range	T_{stg}	-40 to +150	$^\circ\text{C}$

Thermal Characteristics

Rating	Symbol	Value	Unit
Thermal Resistance, Junction-to-Case	R_{bJC}	2.7	$^\circ\text{C/W}$
Maximum Lead Temperature for Soldering Purposes 1/8" from Case for 10 Seconds	T_L	260	$^\circ\text{C}$

Stresses exceeding Maximum Ratings may damage the device. Maximum Ratings are stress ratings only. Functional operation above the Recommended Operating Conditions is not implied. Extended exposure to stresses above the Recommended Operating Conditions may affect device reliability.

- V_{DRM} and V_{RRM} for all types can be applied on a continuous basis. Ratings apply for zero or negative gate voltage; however, positive gate voltage shall not be applied concurrent with negative potential on the anode. Blocking voltages shall not be tested with a constant current source such that the voltage ratings of the devices are exceeded.

Electrical Characteristics - OFF ($T_C = 25^\circ\text{C}$ unless otherwise noted)

Characteristic	Symbol	Min	Typ	Max	Unit	
†Peak Repetitive Blocking Current ($V_{\text{AK}} = V_{\text{DRM}} = V_{\text{RRM}}$; Gate Open)	I_{DRM}^* I_{RRM}	$T_J = 25^\circ\text{C}$	-	-	10	μA
		$T_J = 100^\circ\text{C}$	-	-	2.0	mA

Electrical Characteristics - ON ($T_C = 25^\circ\text{C}$ unless otherwise noted; Electricals apply in both directions)

Characteristic	Symbol	Min	Typ	Max	Unit	
Peak Forward On-State Voltage (Note 2) ($I_{\text{TM}} = \pm 30$ A)	V_{TM}	-	-	2.0	V	
Gate Trigger Current (Continuous dc) ($V_D = 12$ V, $R_L = 100$ Ω)	I_{GT}	MT2(+), G(+)	-	10	25	mA
		MT2(+), G(-)	-	20	60	
		MT2(-), G(-)	-	15	25	
		MT2(-), G(+)	-	30	60	
Gate Trigger Voltage (Continuous dc) (All Four Quadrants) ($V_D = 12$ Vdc, $R_L = 100$ Ω)	V_{GT}	-	1.25	2.5	V	
Gate Non-Trigger Voltage (Continuous dc) ($V_D = 12$ Vdc, $R_L = 100$ Ω , $T_C = 100^\circ\text{C}$)	V_{GD}	0.2	-	-	V	
Holding Current (Main Terminal Voltage = 12 Vdc, Gate Open, Initiating Current) = ± 200 mA)	I_{H}	-	15	30	mA	
Gate Controlled Turn-On Time (Rated V_{DRM} , $I_T = 10$ A, $I_{\text{GT}} = 160$ mA, Rise Time = 0.1 μs)	t_{gt}	-	1.6	-	μs	

Dynamic Characteristics

Characteristic	Symbol	Min	Typ	Max	Unit
Critical Rate-of-Rise of Commutation Voltage ($V_D = \text{Rated } V_{DRM}$, $I_{T(RMS)} = 6 \text{ A}$, Commutating $di/dt = 3.2 \text{ A/ms}$, Gate Unenergized, $T_C = 80^\circ\text{C}$)	$dv/dt_{(c)}$	–	10	–	$\text{V}/\mu\text{s}$
Critical Rate-of-Rise of Off-State Voltage ($V_D = \text{Rated } V_{DRM}$, Exponential Voltage Rise, Gate Open, $T_C = 100^\circ\text{C}$)	dv/dt	–	75	–	$\text{V}/\mu\text{s}$

2. Pulse Test: Pulse Width $\leq 2.0 \text{ ms}$, Duty Cycle $\leq 2\%$.

Voltage Current Characteristic of SCR

Symbol	Parameter
V_{DRM}	Peak Repetitive Forward Off State Voltage
I_{DRM}	Peak Forward Blocking Current
V_{RRM}	Peak Repetitive Reverse Off State Voltage
I_{RRM}	Peak Reverse Blocking Current
V_{TM}	Maximum On State Voltage
I_H	Holding Current

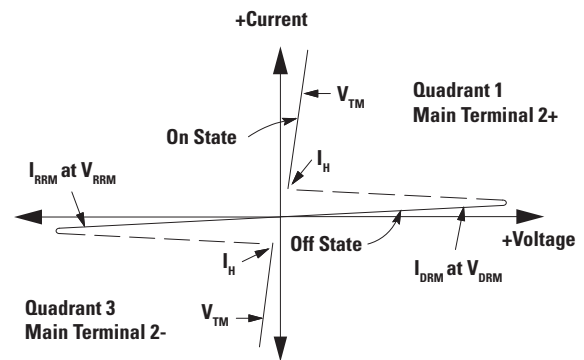

Quadrant Definitions for a Triac

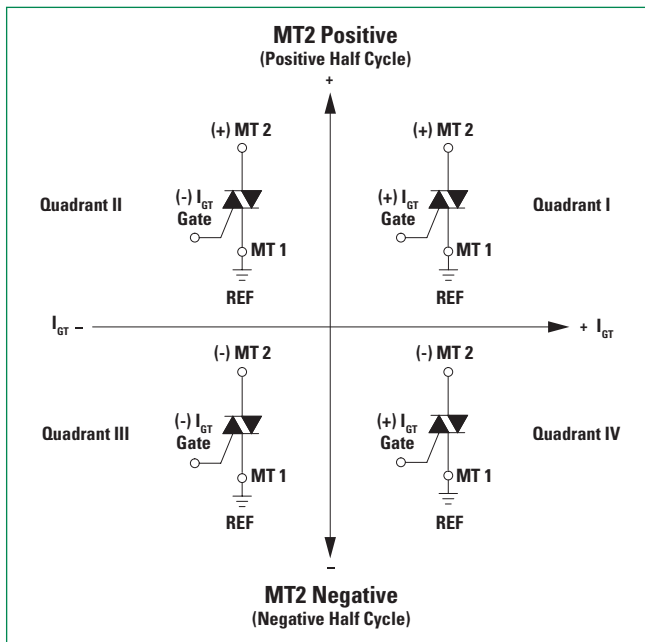

All Polarities are referenced to MT1.
With in-phase signals (using standard AC lines) quadrants I and III are used

Dimensions

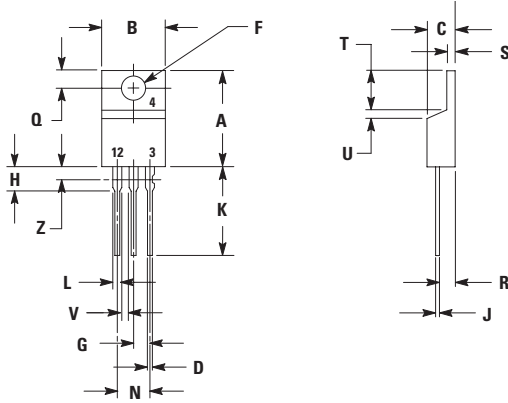

Dim	Inches		Millimeters	
	Min	Max	Min	Max
A	0.590	0.620	14.99	15.75
B	0.380	0.420	9.65	10.67
C	0.178	0.188	4.52	4.78
D	0.025	0.035	0.64	0.89
F	0.142	0.147	3.61	3.73
G	0.095	0.105	2.41	2.67
H	0.110	0.130	2.79	3.30
J	0.018	0.024	0.46	0.61
K	0.540	0.575	13.72	14.61
L	0.060	0.075	1.52	1.91
N	0.195	0.205	4.95	5.21
Q	0.105	0.115	2.67	2.92
R	0.085	0.095	2.16	2.41
S	0.045	0.060	1.14	1.52
T	0.235	0.255	5.97	6.47
U	0.000	0.050	0.00	1.27
V	0.045	—	1.15	—
Z	—	0.080	—	2.04

1. DIMENSIONING AND TOLERANCING PER ANSI Y14.5M, 1982.
2. CONTROLLING DIMENSION: INCH.
3. DIMENSION Z DEFINES A ZONE WHERE ALL BODY AND LEAD IRREGULARITIES ARE ALLOWED.

Part Marking System

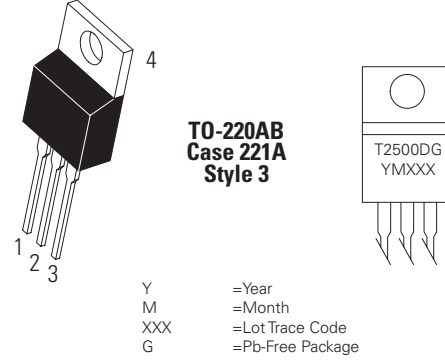

Pin Assignment	
1	Cathode
2	Anode
3	Gate
4	Anode

Ordering Information

Device	Package	Shipping
T2500D	TO220AB	1000 Units/Box
T2500DG	TO220AB (Pb-Free)	