

CoolMOS™ 1) Power MOSFET ISOPLUS™ Package

N-Channel Enhancement Mode
Low $R_{DS(on)}$, high V_{DSS} MOSFET
Electrically Isolated Back Surface

$$I_{D25} = 25 \text{ A}$$

$$V_{DSS} = 800 \text{ V}$$

$$R_{DS(on) \text{ max}} = 150 \text{ m}\Omega$$

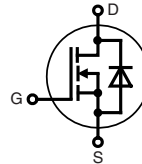
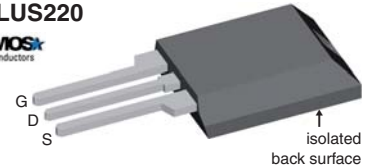
ISOPLUS220
COOLMOS™
Power Semiconductors

E72873

MOSFET			
Symbol	Conditions	Maximum Ratings	
V_{DSS}	$T_{VJ} = 25^\circ\text{C}$	800	V
V_{GS}		± 20	V
I_{D25}	$T_C = 25^\circ\text{C}$	25	A
I_{D90}	$T_C = 90^\circ\text{C}$	18	A
E_{AS}	$T_{J \text{ start}} = 25^\circ\text{C}$; single pulse; $I_D = 3.4 \text{ A}$	670	mJ
E_{AR}	$T_{J \text{ start}} = 25^\circ\text{C}$; repetitive; $I_D = 17 \text{ A}$	0.5	mJ
dV/dt	$V_{DS} < V_{DSS}$; $I_F = 35 \text{ A}$; $T_{VJ} = 150^\circ\text{C}$ $dI_R/dt = 100 \text{ A}/\mu\text{s}$	6	V/ns

Features

- Silicon chip on Direct-Copper-Bond substrate
 - high power dissipation
 - isolated mounting surface
 - 2500 V electrical isolation
- 3rd generation CoolMOS™ 1) power MOSFET
 - high blocking capability
 - lowest resistance
 - avalanche rated for unclamped inductive switching (UIS)
- Low thermal resistance due to reduced chip thickness
- Low drain to tab capacitance (<30 pF)

Symbol	Conditions	Characteristic Values			
		(T _{VJ} = 25°C, unless otherwise specified)			
		min.	typ.	max.	
$R_{DS(on)}$	$V_{GS} = 10 \text{ V}$; $I_D = I_{D90}$		135	150	mΩ
$V_{GS(th)}$	$V_{DS} = V_{GS}$; $I_D = 2 \text{ mA}$	2		4	V
I_{DSS}	$V_{DS} = V_{DSS}$; $V_{GS} = 0 \text{ V}$			50	μA
			250		μA
I_{GSS}	$V_{GS} = \pm 20 \text{ V}$; $V_{DS} = 0 \text{ V}$			± 200	nA
C_{iss}	$V_{GS} = 0 \text{ V}$; $V_{DS} = 25 \text{ V}$; $f = 1 \text{ MHz}$		4600		pF
C_{oss}			2500		pF
C_{rss}			120		pF
Q_g	$V_{GS} = 0 \text{ to } 10 \text{ V}$; $V_{DS} = 640 \text{ V}$; $I_D = I_{D90}$		180		nC
Q_{gs}			20		nC
Q_{gd}			80		nC
$t_{d(on)}$	$V_{GS} = 10 \text{ V}$; $V_{DS} = 640 \text{ V}$; $T_{VJ} = 125^\circ\text{C}$ $I_D = 35 \text{ A}$; $R_G = 2.2 \Omega$		25		ns
t_r			25		ns
$t_{d(off)}$			75		ns
t_f			10		ns
R_{thJC}			0.5		K/W

Applications

- Switched mode power supplies (SMPS)
- Uninterruptible power supplies (UPS)
- Power factor correction (PFC)
- Welding
- Inductive heating

Advantages

- Easy assembly: no screws or isolation foils required
- Space savings
- High power density

¹⁾ CoolMOS™ is a trademark of Infineon Technologies AG.

Source-Drain Diode

Symbol	Conditions	Characteristic Values			
		min.	typ.	max.	
($T_{VJ} = 25^{\circ}\text{C}$, unless otherwise specified)					
I_S	$V_{GS} = 0\text{ V}$			34	A
V_{SD}	$I_F = 35\text{ A}; V_{GS} = 0\text{ V}$		1.0	1.2	V
t_{rr}	} $I_F = 35\text{ A}; -di_F/dt = 200\text{ A}/\mu\text{s}; V_R = 400\text{ V}$		550		ns
Q_{RM}			30		μC
I_{RM}			100		A

Component

Symbol	Conditions	Maximum Ratings	
T_{VJ}	operating	-55...+150	$^{\circ}\text{C}$
T_{stg}		-55...+150	$^{\circ}\text{C}$
V_{ISOL}	RMS, lead-to-tab, 50/60 Hz, $f = 1$ minute	2500	V~
F_C	mounting force	11-65/2.4-11	N/lb.

Symbol	Conditions	Characteristic Values		
		min.	typ.	max.
R_{thCH}	with heatsink compound	0.15		K/W
Weight		2.7		g

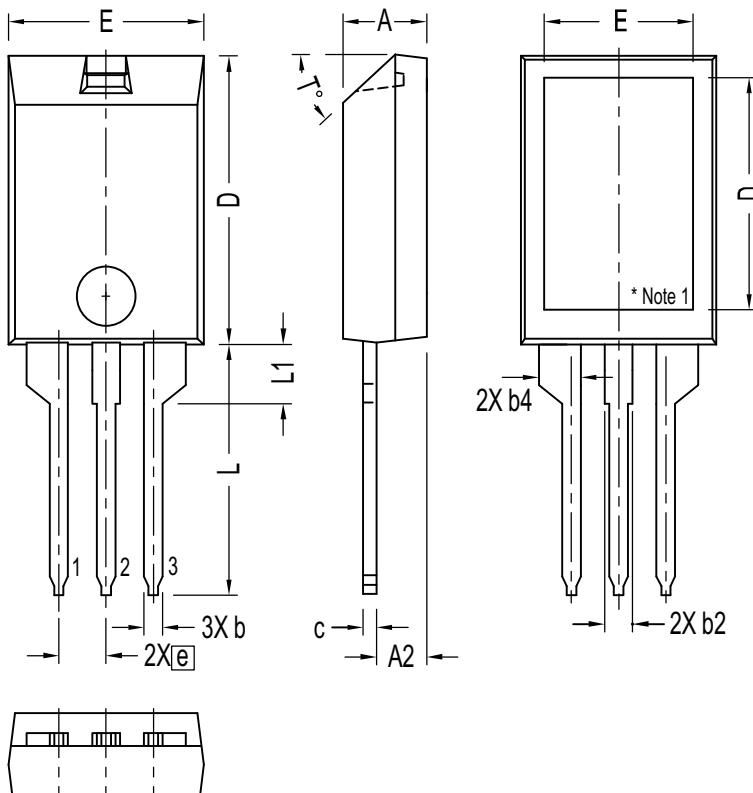
ISOPLUS220™ Outline

SYM	INCHES		MILLIMETERS	
	MIN	MAX	MIN	MAX
A	.157	.197	4.00	5.00
A2	.098	.118	2.50	3.00
b	.035	.051	0.90	1.30
b2	.049	.065	1.25	1.65
b4	.093	.100	2.35	2.55
c	.028	.039	0.70	1.00
D	.591	.630	15.00	16.00
D1	.472	.512	12.00	13.00
E	.394	.433	10.00	11.00
E1	.295	.335	7.50	8.50
e	.100 BASIC		2.55	BASIC
L	.512	.571	13.00	14.50
L1	.118	.138	3.00	3.50
T°			42.5°	47.5°

NOTE:

1. Bottom heatsink is electrically isolated from Pin 1, 2, or 3.
2. This drawing will meet dimensional requirement of JEDEC SS Product Outline TO-273 except D and D1 dimension.

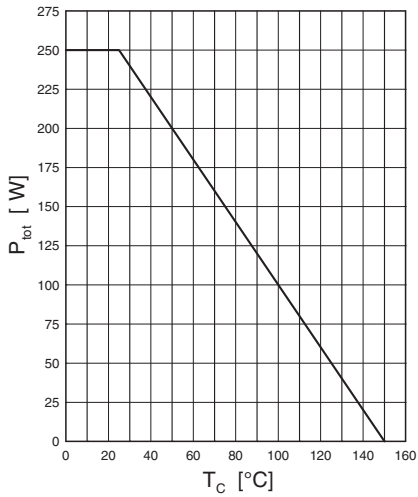

Fig. 1 Power Dissipation

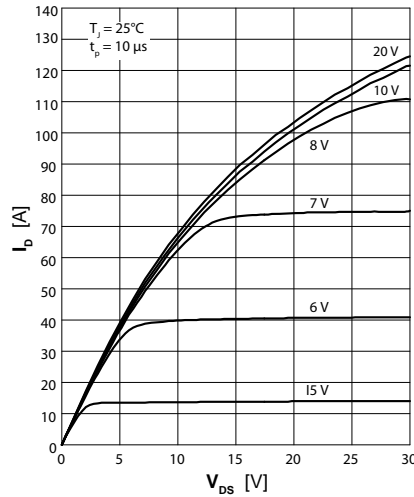

Fig. 2 Typ. Output Characteristics

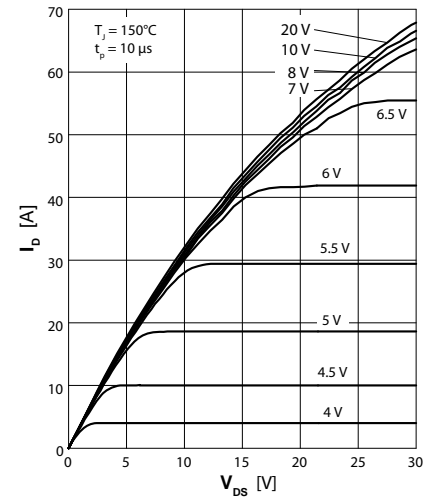

Fig. 3 Typ. Output Characteristics

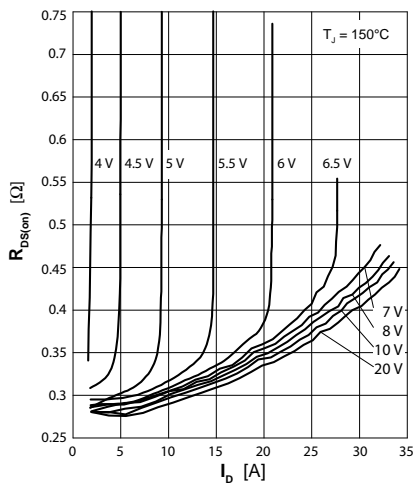

Fig. 4 Typ. Drain-Source on Resistance

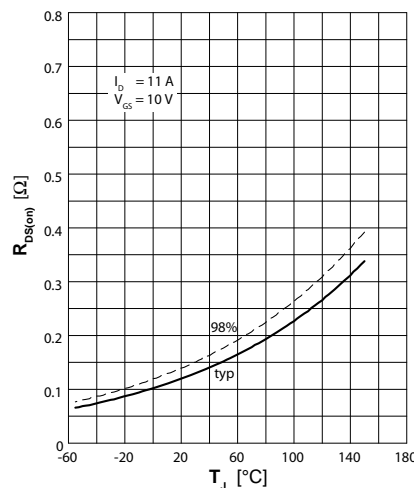

Fig. 5 Drain-Source On-State Resistance

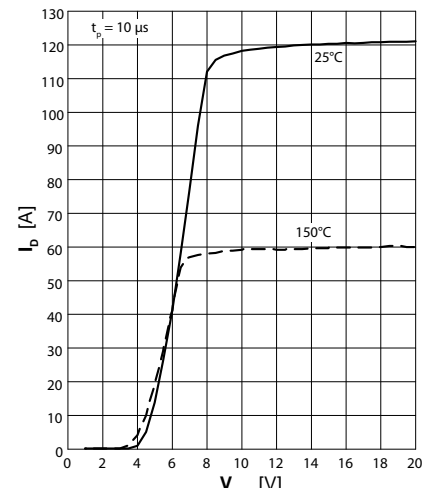

Fig. 6 Typ. Transfer Characteristics

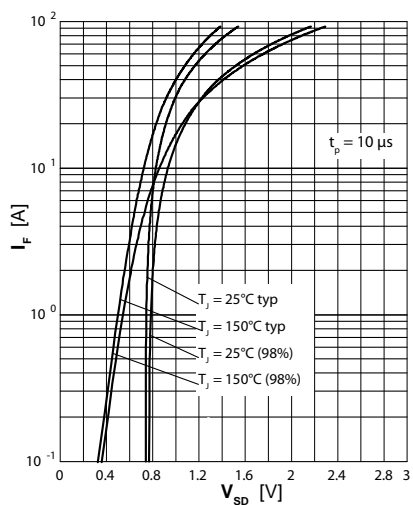

Fig. 7 Forward Characteristics of Body Diode

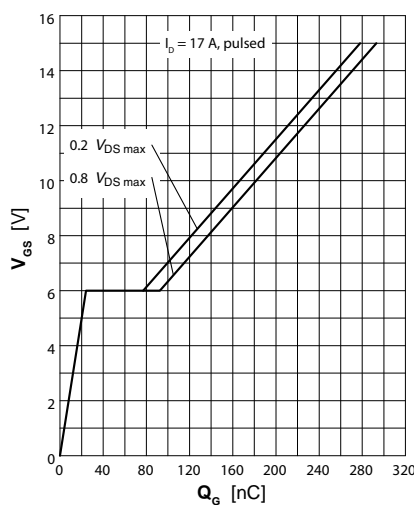

Fig. 8 Typ. Gate Charge

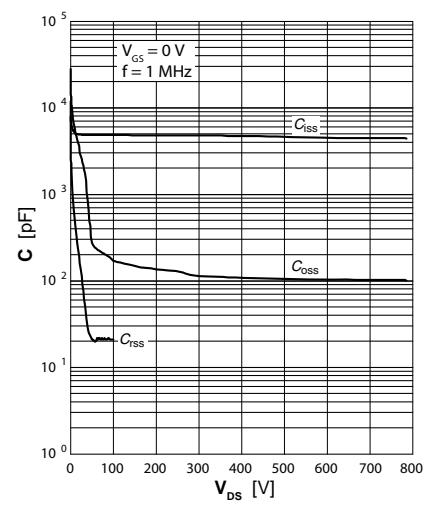

Fig. 9 Capacitance

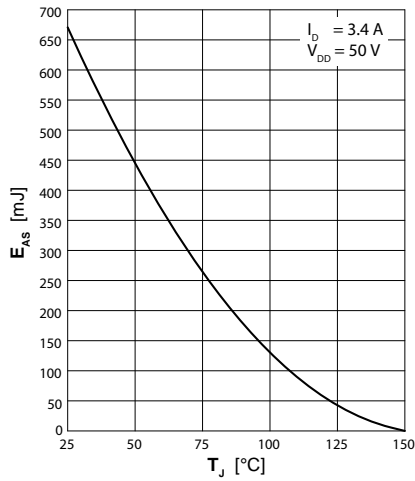

Fig. 10 Typ. Avalanche Energy

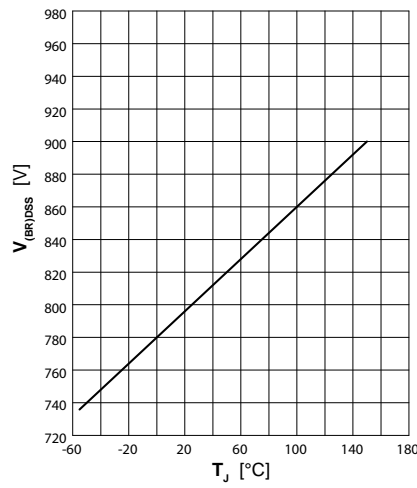

Fig. 11 Drain-Source Breakdown Voltage

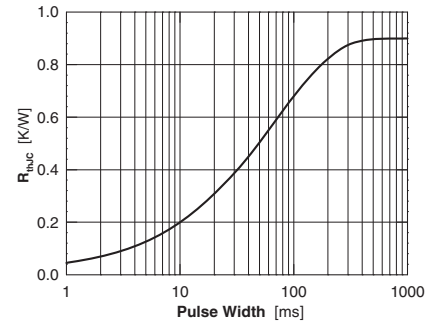

Fig. 12 Maximum Transient Thermal Resistance



Disclaimer Notice - Information furnished is believed to be accurate and reliable. However, users should independently evaluate the suitability of and test each product selected for their own applications. Littelfuse products are not designed for, and may not be used in, all applications. Read complete Disclaimer Notice at www.littelfuse.com/disclaimer-electronics.