

MCR8DSM, MCR8DSN

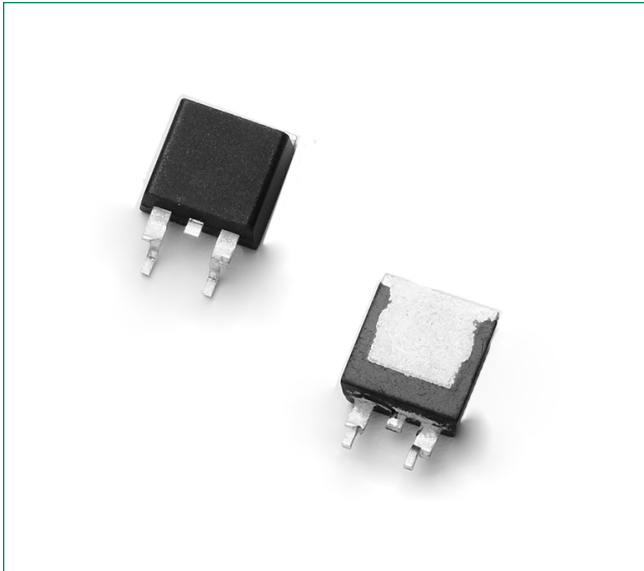

Description

Designed for high volume, low cost, industrial and consumer applications such as motor control; process control; temperature, light and speed control.

Features

- Small Size
- Passivated Die for Reliability and Uniformity
- Low Level Triggering and Holding Characteristics
- Available in Two Package Styles Surface Mount Lead Form – Case 369C Miniature Plastic Package – Straight Leads – Case 369
- Epoxy Meets UL 94 V-0 @ 0.125 in
- ESD Ratings: Human Body Model, 3B > 8000 V Machine Model, C > 400V
- Pb-Free Packages are Available

Pin Out

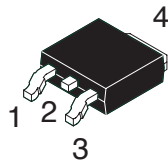

Functional Diagram



Additional Information



Datasheet



Resources



Samples

Maximum Ratings ($T_J = 25^\circ\text{C}$ unless otherwise noted)

Rating		Symbol	Value	Unit
Peak Repetitive Off-State Voltage (Note 1) ($T_J = -40$ to 110°C , Sine Wave, 50 to 60 Hz)	MCR8DSM	V_{DRM}^*	600	V
	MCR8DSN	V_{RRM}	800	
On-State RMS Current (180° Conduction Angles; $T_C = 90^\circ\text{C}$)		$I_T (RMS)$	8.0	A
Average On-State Current (180° Conduction Angles; $T_C = 90^\circ\text{C}$)		$I_{T(AV)}$	5.1	A
Peak Non-Repetitive Surge Current (1/2 Cycle, Sine Wave 60 Hz, $T_J = 110^\circ\text{C}$)		I_{TSM}	90	A
Circuit Fusing Consideration ($t = 8.3$ ms)		I^2t	34	A ² sec
Forward Peak Gate Power (Pulse Width ≤ 10 μsec , $T_C = 90^\circ\text{C}$)		P_{GM}	5.0	W
Forward Average Gate Power ($t = 8.3$ msec, $T_C = 90^\circ\text{C}$)		$P_{GM(AV)}$	0.5	W
Forward Peak Gate Current (Pulse Width ≤ 10 μsec , $T_C = 90^\circ\text{C}$)		I_{GM}	2.0	A
Operating Junction Temperature Range		T_J	-40 to 110	$^\circ\text{C}$
Storage Temperature Range		T_{stg}	-40 to 150	$^\circ\text{C}$

Stresses exceeding Maximum Ratings may damage the device. Maximum Ratings are stress ratings only. Functional operation above the Recommended Operating Conditions is not implied. Extended exposure to stresses above the Recommended Operating Conditions may affect device reliability.

- V_{DRM} and V_{RRM} for all types can be applied on a continuous basis. Ratings apply for zero or negative gate voltage; however, positive gate voltage shall not be applied concurrent with negative potential on the anode. Blocking voltages shall not be tested with a constant current source such that the voltage ratings of the devices are exceeded.

Thermal Characteristics

Rating	Symbol	Value	Unit
Thermal Resistance, Junction-to-Case	$R_{\theta JC}$	2.2	$^\circ\text{C}/\text{W}$
Thermal Resistance, Junction-to-Ambient	$R_{\theta JA}$	88	
Thermal Resistance, Junction-to-Ambient (Note 2)	$R_{\theta JA}$	80	
Maximum Lead Temperature for Soldering Purposes 1/8" from Case for 10 Seconds	T_L	260	$^\circ\text{C}$

Electrical Characteristics - OFF ($T_J = 25^\circ\text{C}$ unless otherwise noted)

Characteristic		Symbol	Min	Typ	Max	Unit
Peak Repetitive Forward or Reverse Blocking Current (Note 3) ($V_{AK} = \text{Rated } V_{DRM} \text{ or } V_{RRM}$, $R_{GK} = 1.0$ k Ω)	$T_J = 25^\circ\text{C}$	I_{DRM}^* I_{RRM}	-	-	10	μA
	$T_J = 110^\circ\text{C}$		-	-	500	

Electrical Characteristics - ON ($T_J = 25^\circ\text{C}$ unless otherwise noted; Electricals apply in both directions)

Characteristic		Symbol	Min	Typ	Max	Unit
Peak Reverse Gate Blocking Voltage ($I_{GR} = 10$ μA)		V_{GRM}	10	12.5	18	V
Peak Reverse Gate Blocking Current ($V_{GR} = 10$ V)		I_{RGM}	-	-	1.2	μA
Peak Forward On-State Voltage (Note 4) ($I_{TM} = 16$ A)		V_{TM}	-	1.4	1.8	V
Gate Trigger Current (Continuous dc) (Note 5) ($V_{AK} = 12$ Vdc, $R_L = 100$ Ω)	$(T_J = 25^\circ\text{C})$	I_{GT}	5.0	12	200	μA
	$(T_J = -40^\circ\text{C})$		-	-	300	
Gate Trigger Voltage (Continuous dc) ($V_D = 12$ V, $R_L = 100$ Ω) (Note 5)	$(T_J = 25^\circ\text{C})$	V_{GT}	0.45	0.65	1.0	V
	$(T_J = -40^\circ\text{C})$		-	-	1.5	
	$(T_J = 110^\circ\text{C})$		0.2	-	-	
Holding Current ($V_D = 12$ V, Initiating Current = 200 mA, $R_{GK} = 1$ k Ω)	$(T_J = 25^\circ\text{C})$	I_H	0.5	1.0	6.0	mA
	$(T_J = -40^\circ\text{C})$		-	-	10	
Latching Current ($V_D = 12$ V, IG = 2.0 mA, $R_{GK} = 1$ k Ω)	$(T_J = 25^\circ\text{C})$	I_L	0.5	1.0	6.0	mA
	$(T_J = -40^\circ\text{C})$		-	-	10	
Total Turn-On Time (Source Voltage = 12 V, $R_s = 6.0$ k Ω , IT = 16 A(pk), $R_{GK} = 1.0$ k Ω) (VD = Rated V_{DRM} , Rise Time = 20 ns, Pulse Width = 10 μs)		tgt	-	2.0	5.0	μs

Dynamic Characteristics

Characteristic	Symbol	Min	Typ	Max	Unit
Critical Rate of Rise of Off-State Voltage ($V_D = 0.67 \times \text{Rated } V_{DRM}$, Exponential Waveform, $R_{GK} = 100 \Omega$, $T_J = 110^\circ\text{C}$)	dv/dt	37	45	-	V/ μs

- Surface mounted on minimum recommended pad size.
- Ratings apply for negative gate voltage or $R_{GK} = 1.0 \text{ k}\Omega$. Devices shall not have a positive gate voltage concurrently with a negative voltage on the anode. Devices should not be tested with a constant current source for forward and reverse blocking capability such that the voltage applied exceeds the rated blocking voltage.
- Pulse Test; Pulse Width $\leq 2.0 \text{ msec}$, Duty Cycle $\leq 2\%$.
- R_{GK} current not included in measurements.

Voltage Current Characteristic of SCR

Symbol	Parameter
V_{DRM}	Peak Repetitive Forward Off State Voltage
I_{DRM}	Peak Forward Blocking Current
V_{RRM}	Peak Repetitive Reverse Off State Voltage
I_{RRM}	Peak Reverse Blocking Current
V_{TM}	Maximum On State Voltage
I_H	Holding Current

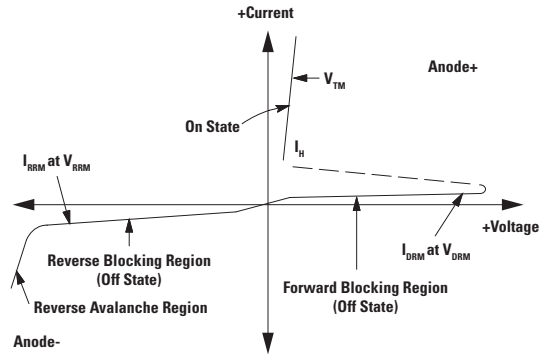

Figure 1. Average Current Derating

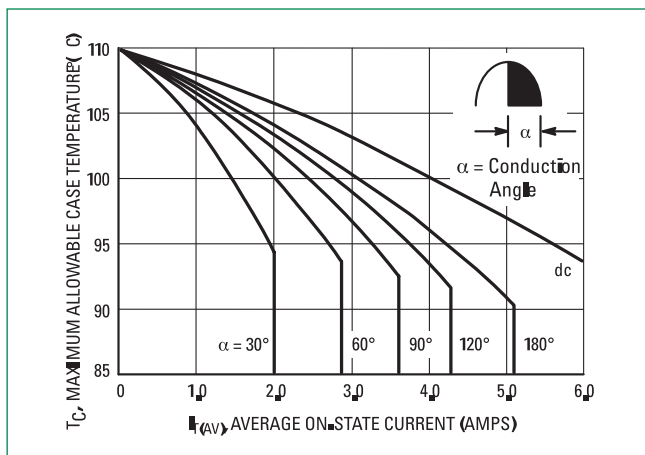

Figure 2. On-State Power Dissipation

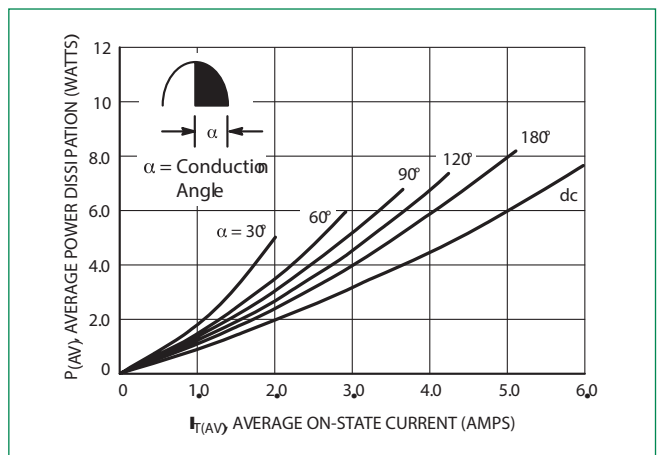

Figure 3. On-State Characteristics

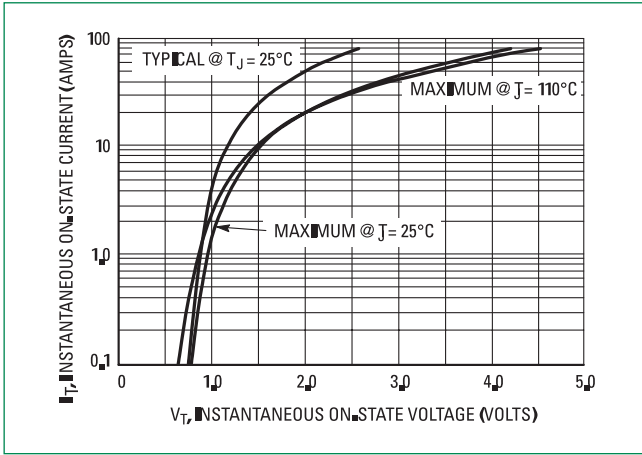

Figure 4. Transient Thermal Response

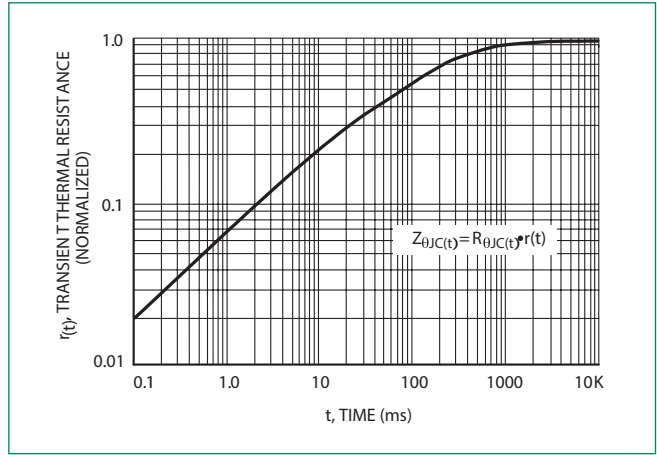

Figure 5. Typical Gate Trigger Current vs Junction Temperature

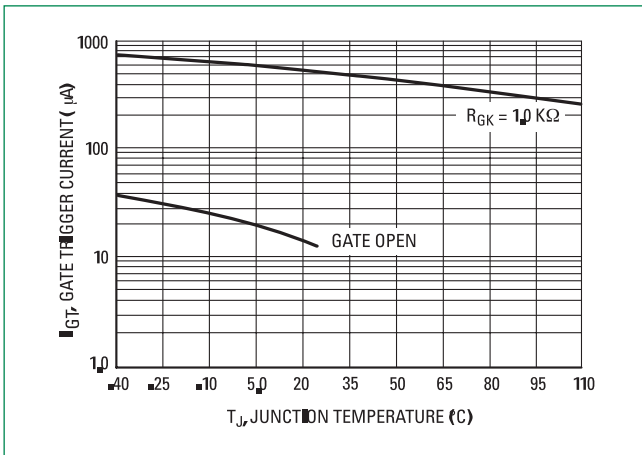

Figure 6. Typical Gate Trigger Voltage vs Junction Temperature

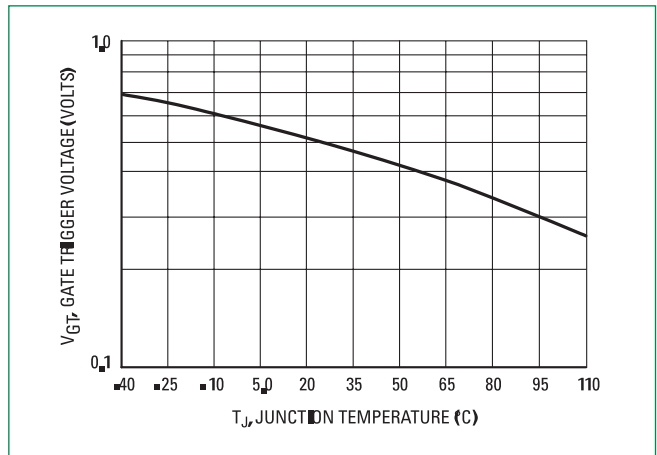

Figure 7. Typical Holding Current vs Junction Temperature

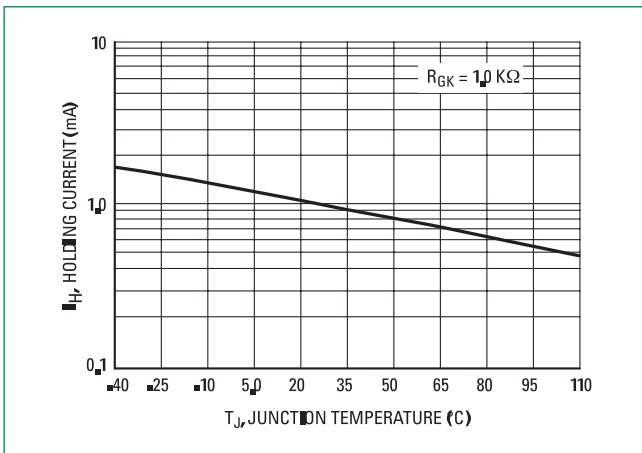

Figure 8. Typical Latching Current vs Junction Temperature

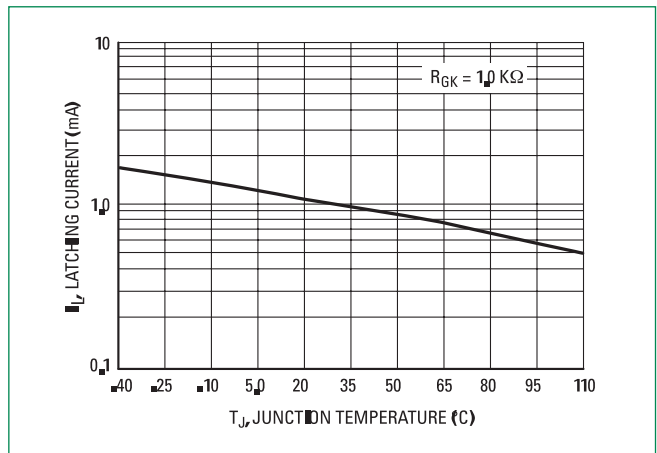

Figure 9. Holding Current versus Gate–Cathode Resistance

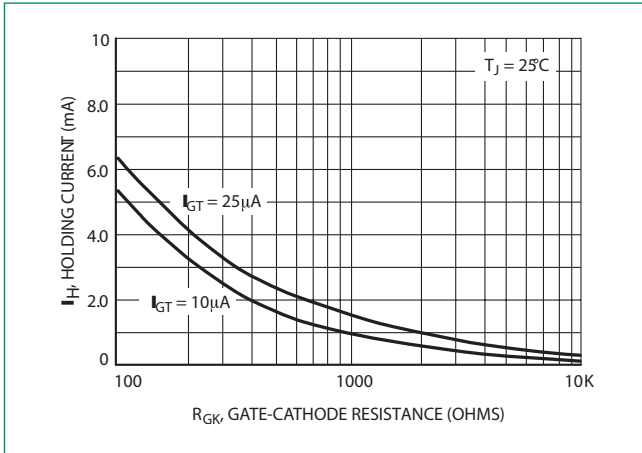

Figure 10. Exponential Static dv/dt vs Gate–Cathode Resistance and Junction Temperature

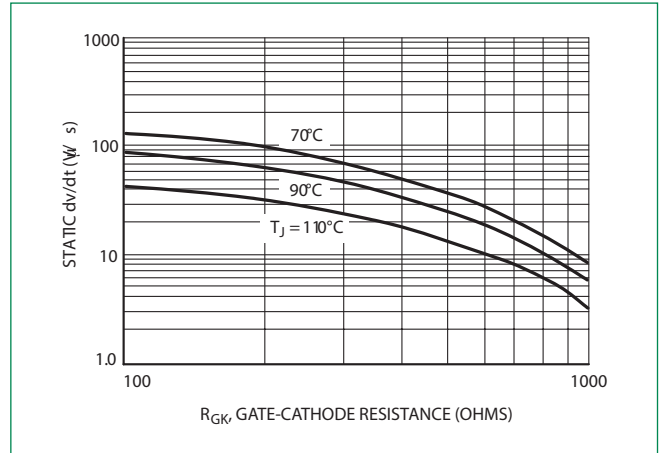

Figure 11. Exponential Static dv/dt vs Gate–Cathode Resistance and Peak Voltage

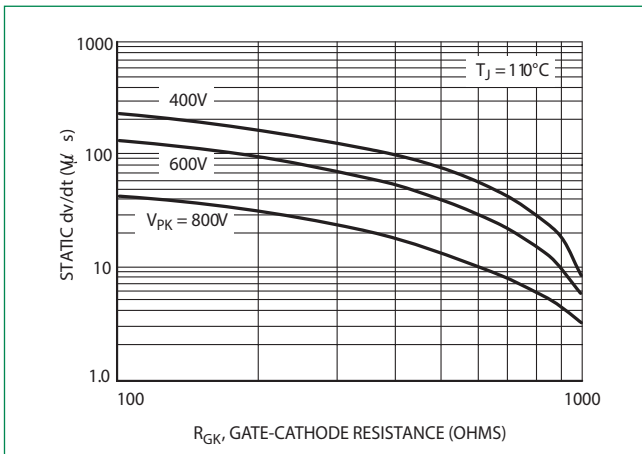
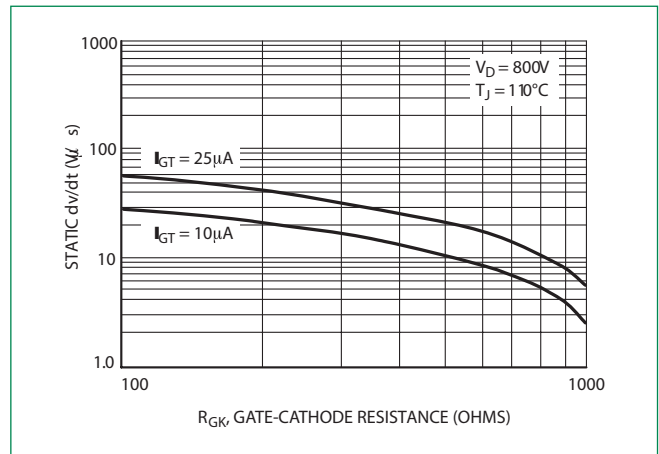
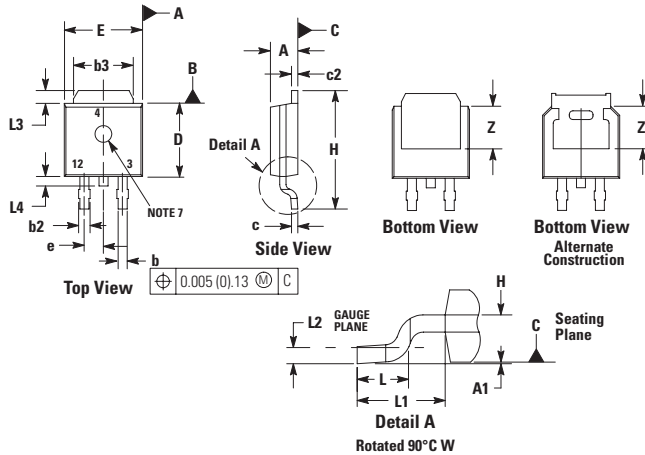

Figure 12. Exponential Static dv/dt vs Gate–Cathode Resistance and Gate Trigger Current Sensitivity



Dimensions



Soldering Footprint

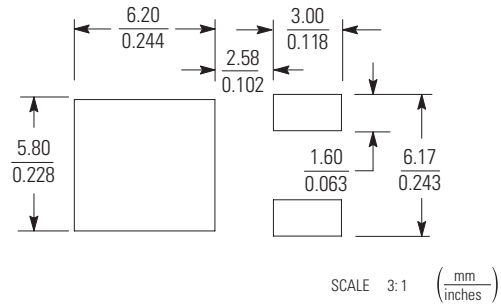

Part Marking System

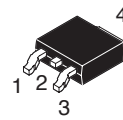

DPAK-3
Case 369C
Style 6

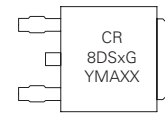

CR8DSx = Device Code
x = D, M, or N
Y = Year
M = Month
A = Assembly Site
XX = Lot Serial Code
G = Pb-Free Package

Dim	Inches		Millimeters	
	Min	Max	Min	Max
A	0.087	0.094	2.20	2.40
A1	0.000	0.005	0.00	0.12
b	0.022	0.030	0.55	0.75
b2	0.026	0.033	0.65	0.85
b3	0.209	0.217	5.30	5.50
c	0.019	0.023	0.49	0.59
c2	0.019	0.023	0.49	0.59
D	0.213	0.224	5.40	5.70
E	0.252	0.260	6.40	6.60
e	0.091		2.30	
H	0.374	0.406	9.50	10.30
L	0.058	0.070	1.47	1.78
L1	0.114		2.90	
L2	0.020		0.51	
L3	0.053	0.065	1.35	1.65
L4	0.028	0.039	0.70	1.00
Z	0.154	-	3.90	-

1. DIMENSIONING AND TOLERANCING PER ANSI Y14.5M, 1982.
2. CONTROLLING DIMENSION: INCH.

STYLE 6:
PIN 1. MT1
2. MT2
3. GATE
4. MT2

Pin Assignment

1	Cathode
2	Anode
3	Gate
4	Anode

Ordering Information

Device	Package	Shipping
MCR8DSMT4	DPAK	2500/Tape & Reel
MCR8DSMT4G	DPAK (Pb-Free)	
MCR8DSNT4	DPAK	
MCR8DSNT4G	DPAK (Pb-Free)	