

# SiC Schottky Diode

 $V_{RRM} = 1200\text{ V}$   
 $I_{FAV} = 2 \times 18.5\text{ A}$ 

Ultra fast switching  
 Zero reverse recovery  
 Common Cathode

Part number  
**DCG35C1200HR**

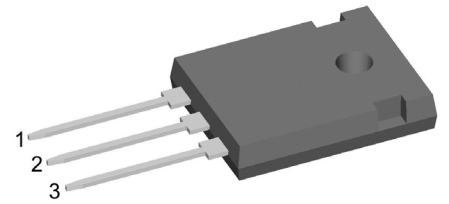

Backside: isolated

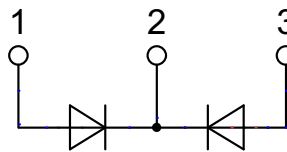
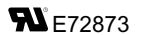

### Features / Advantages:

- Ultra fast switching
- Zero reverse recovery
- Zero forward recovery
- Temperature independent switching behavior
- Positive temperature coefficient of forward voltage
- $T_{VJM} = 175^{\circ}\text{C}$

### Applications:

- Solar inverter
- Uninterruptible power supply (UPS)
- Welding equipment
- Switched-mode power supplies
- Medical equipment
- High speed rectifier

### Package: ISO247

- Isolation Voltage: 3000 V~
- Industry standard outline
- RoHS compliant
- Epoxy meets UL 94V-0
- Soldering pins for PCB mounting
- Backside: DCB ceramic
- Reduced weight
- Advanced power cycling

### Disclaimer Notice

Information furnished is believed to be accurate and reliable. However, users should independently evaluate the suitability of and test each product selected for their own applications. Littelfuse products are not designed for, and may not be used in, all applications. Read complete Disclaimer Notice at [www.littelfuse.com/disclaimer-electronics](http://www.littelfuse.com/disclaimer-electronics).

SiC Diode (per diode)				Ratings				
Symbol	Definitions	Conditions	min.	typ.	max.			
$V_{RSM}$	max. non-repetitive reverse blocking voltage				1200	V		
$V_{RRM}$	max. repetitive reverse blocking voltage				1200	V		
$I_R$	reverse current	$V_R = V_{RRM}$	$T_{VJ} = 25^\circ\text{C}$		35	200	$\mu\text{A}$	
			$T_{VJ} = 175^\circ\text{C}$		65	400	$\mu\text{A}$	
$V_F$	forward voltage	$I_F = 20\text{ A}$ $I_F = 40\text{ A}$	$T_{VJ} = 25^\circ\text{C}$		1.5	1.8	V	
			$T_{VJ} = 175^\circ\text{C}$		2.2	3.0	V	
		$I_F = 20\text{ A}$ $I_F = 40\text{ A}$	$T_{VJ} = 175^\circ\text{C}$					V
								V
$I_{FAV}$	average forward current	$T_C = 80^\circ\text{C}$ $T_C = 100^\circ\text{C}$	rectangular, d = 0.5 $T_{VJ} = 175^\circ\text{C}$		18.5	A		
					17.0	A		
$I_{F25}$	forward current	based on typ. $V_{F0}$ and $r_F$	$T_C = 25^\circ\text{C}$		34	A		
$I_{F80}$			$T_C = 80^\circ\text{C}$		26.5	A		
$I_{F100}$			$T_C = 100^\circ\text{C}$		23	A		
$I_{FSM}$	max forward surge current	t = 10 ms, half sine (50 Hz) $t_p = 10\ \mu\text{s}$ , pulse	$T_{VJ} = 25^\circ\text{C}$ $V_R = 0\text{V}$		1000	A		
$V_{F0}$	threshold voltage	} for power loss calculation	$T_{VJ} = 125^\circ\text{C}$		0.78	V		
$r_F$	slope resistance		$T_{VJ} = 175^\circ\text{C}$		0.73	V		
			$T_{VJ} = 125^\circ\text{C}$		57.0	m $\Omega$		
			$T_{VJ} = 175^\circ\text{C}$		70.5	m $\Omega$		
$Q_C$	total capacitive charge	$V_R = 800\text{ V}$ , $I_F = 20\text{ A}$ $di/dt = 200\text{ A}/\mu\text{s}$	$T_{VJ} = 25^\circ\text{C}$		99	nC		
$C$	total capacitance	$V_R = 0\text{ V}$ $V_R = 400\text{ V}$ $V_R = 800\text{ V}$	$T_{VJ} = 25^\circ\text{C}$ , f = 1 MHz		1500	pF		
					93	pF		
					67	pF		
$R_{thJC}$	thermal resistance junction to case	with heatsink compound; IXYS test setup			1.4	K/W		
$R_{thJH}$	thermal resistance junction to heatsink			1.6	K/W			

Package ISO247				Ratings		
Symbol	Definitions	Conditions	min.	typ.	max.	
$I_{RMS}$	RMS current	per terminal			70	A
$T_{stg}$	storage temperature		-40		150	°C
$T_{op}$	operation temperature		-40		150	°C
$T_{VJ}$	virtual junction temperature		-40		175	°C
<b>Weight</b>				6		g
$M_D$	mounting torque		0.8		1.2	Nm
$F_C$	mounting force with clip		40		120	N
$d_{Spp/App}$	creepage distance on surface /	terminal to terminal	2.7			mm
$d_{Spb/Appb}$	striking distance through air	terminal to backside	4.1			mm
$V_{ISOL}$	isolation voltage	$t = 1$ second $t = 1$ minute		3600 3000		V V
		50/60 Hz; RMS; $I_{ISOL} < 1$ mA				

### Product Marking

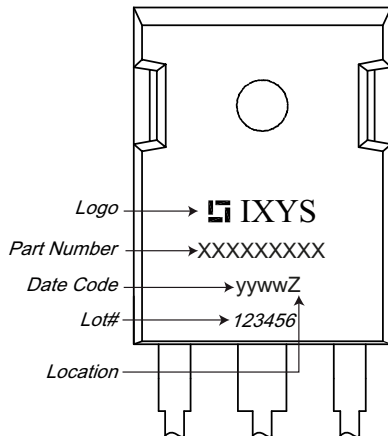

### Part description

D = Diode  
 C = SiC  
 G = Extreme fast  
 35 = Current Rating [A]  
 C = Common Cathode  
 1200 = Reverse Voltage [V]  
 HR = ISO247 (3)

Ordering	Part Name	Marking on Product	Delivering Mode	Base Qty	Ordering Code
Standard	DCG35C1200HR	DCG35C1200HR	Tube	30	DCG35C1200HR

### Equivalent Circuits for Simulation \*on die level, typical

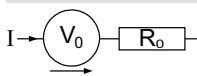
		$T_{VJ} = 125^{\circ}\text{C}$	$T_{VJ} = 175^{\circ}\text{C}$	
		$V_{0\max}$	threshold voltage	0.78
$R_{0\max}$	slope resistance *	57.0	70.5	mΩ

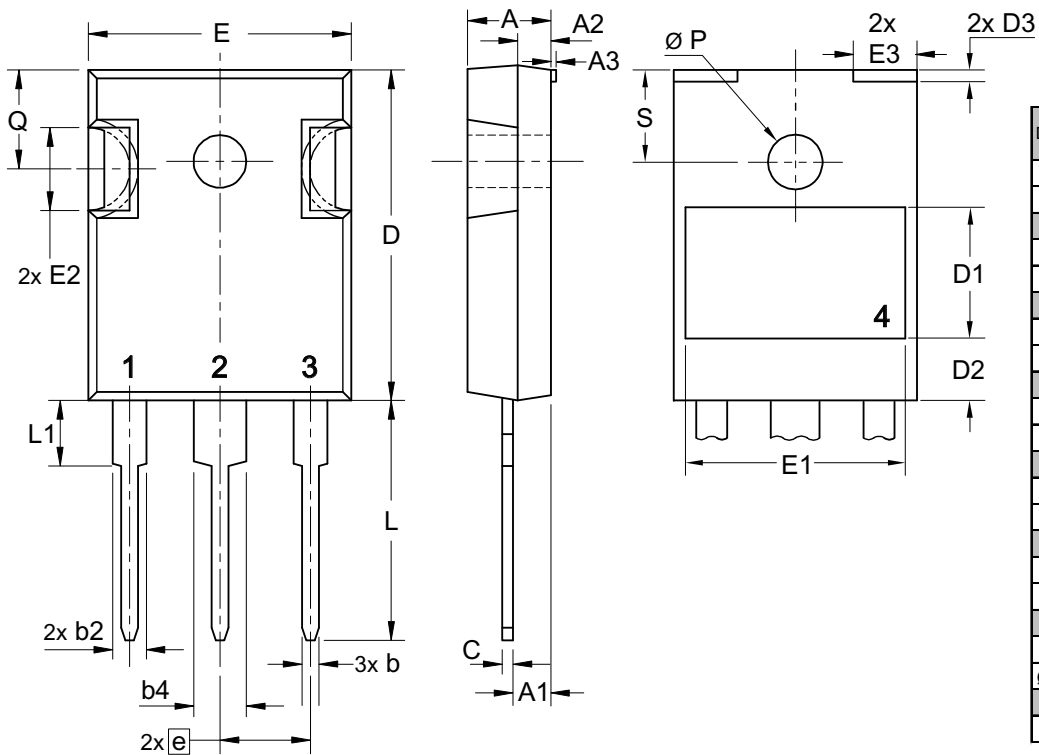
**Outlines ISO247**

Dim.	Millimeter		Inches	
	min	max	min	max
A	4.70	5.30	0.185	0.209
A1	2.21	2.59	0.087	0.102
A2	1.50	2.49	0.059	0.098
A3	typ. 0.05		typ. 0.002	
b	0.99	1.40	0.039	0.055
b2	1.65	2.39	0.065	0.094
b4	2.59	3.43	0.102	0.135
c	0.38	0.89	0.015	0.035
D	20.79	21.45	0.819	0.844
D1	typ. 8.90		typ. 0.350	
D2	typ. 2.90		typ. 0.114	
D3	typ. 1.00		typ. 0.039	
E	15.49	16.24	0.610	0.639
E1	typ. 13.45		typ. 0.530	
E2	4.31	5.48	0.170	0.216
E3	typ. 4.00		typ. 0.157	
e	5.46 BSC		0.215 BSC	
L	19.80	20.30	0.780	0.799
L1	-	4.49	-	0.177
Ø P	3.55	3.65	0.140	0.144
Q	5.38	6.19	0.212	0.244
S	6.14 BSC		0.242 BSC	

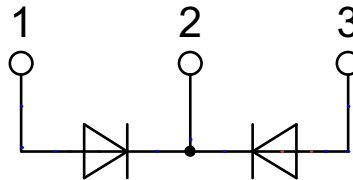

**SiC Diode (per diode)**

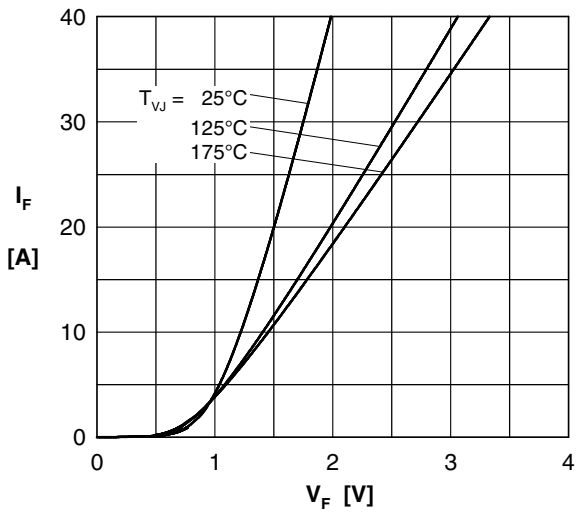

Fig. 1 Typ. forward characteristics.

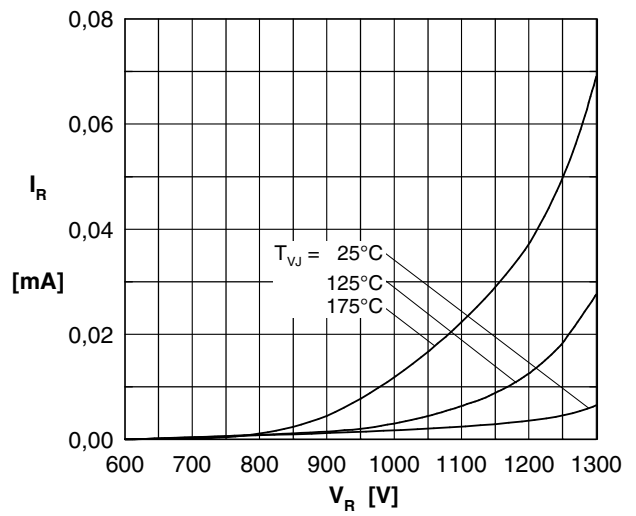

Fig. 2 Typ. reverse characteristics

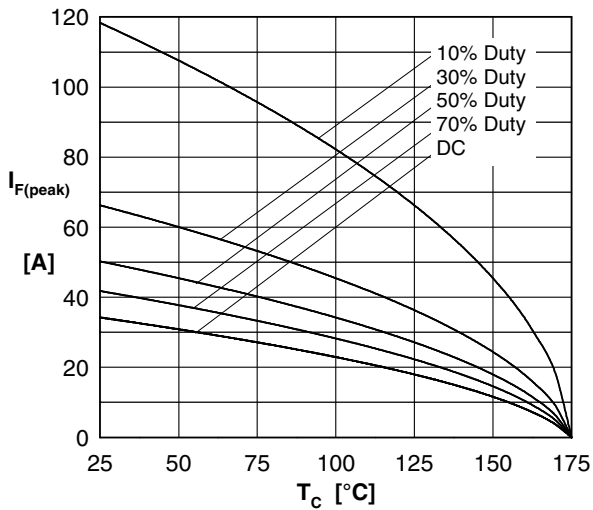

Fig. 3 Typ. current derating

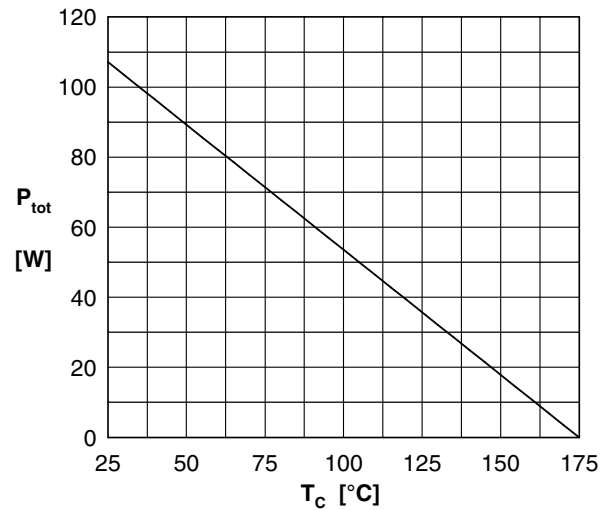

Fig. 4 Power derating

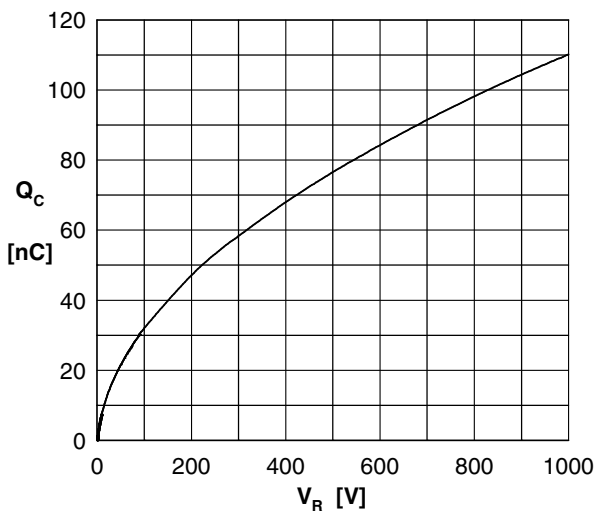

Fig. 5 Typ. recovery charge vs. reverse voltage

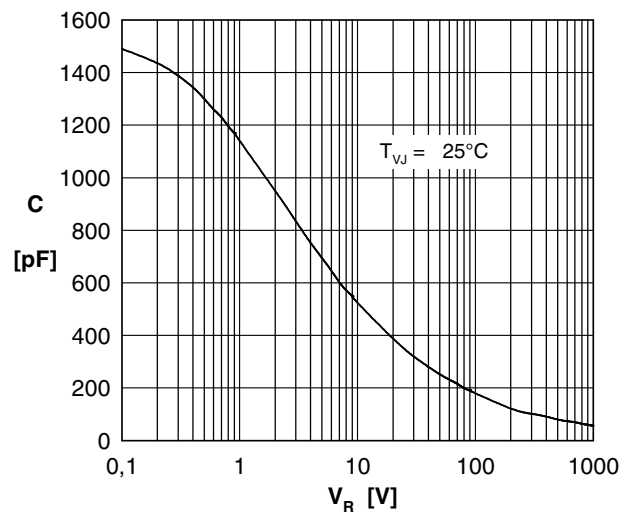

Fig. 6 Typ. junction capacitance vs. reverse Voltage

**SiC Diode (per diode)**

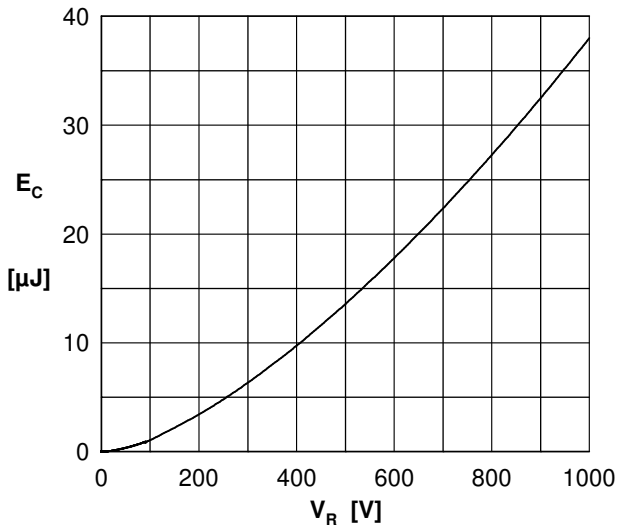

Fig. 7 Typical capacitance stored energy

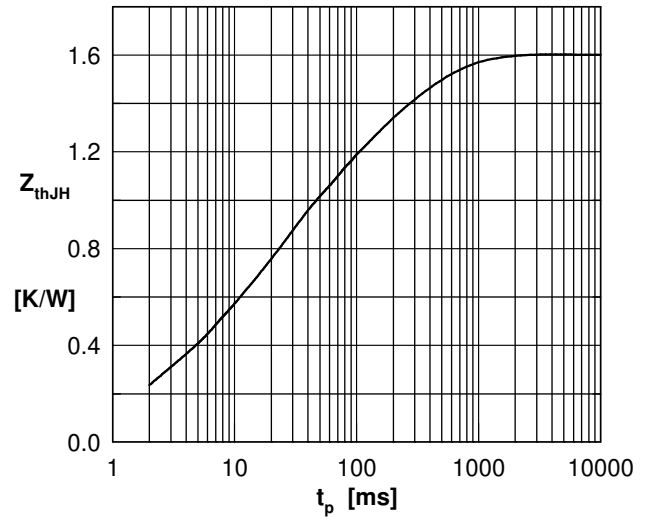

Fig. 8 Typ. transient thermal impedance junction to heatsink