

Standard Power MOSFET

P-Channel Enhancement Mode
Avalanche Rated

IXTH 24P20
IXTT 24P20

$V_{DSS} = -200 \text{ V}$
 $I_{D25} = -24 \text{ A}$
 $R_{DS(on)} \leq 0.15 \text{ } \Omega$

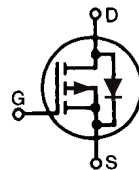

Symbol	Test Conditions	Maximum Ratings	
V_{DSS}	$T_J = 25^\circ\text{C}$ to 150°C	-200	V
V_{DGR}	$T_J = 25^\circ\text{C}$ to 150°C ; $R_{GS} = 1 \text{ M}\Omega$	-200	V
V_{GS}	Continuous	± 20	V
V_{GSM}	Transient	± 30	V
I_{D25}	$T_C = 25^\circ\text{C}$	-24	A
I_{DM}	$T_C = 25^\circ\text{C}$, pulse width limited by T_J	-96	A
I_{AR}	$T_C = 25^\circ\text{C}$	-24	A
E_{AR}	$T_C = 25^\circ\text{C}$	30	mJ
P_D	$T_C = 25^\circ\text{C}$	300	W
T_J		-55 ... +150	$^\circ\text{C}$
T_{JM}		150	$^\circ\text{C}$
T_{stg}		-55 ... +150	$^\circ\text{C}$
	Maximum lead temperature for soldering 1.6 mm (0.062 in.) from case for 10 s	400	$^\circ\text{C}$
	Plastic Body for 10s	250	$^\circ\text{C}$
M_d	Mounting torque (TO-247)	1.13/10	Nm/lb.in.
Weight	TO-247	6	g
	TO-268	5	g

TO-247 (IXTH)

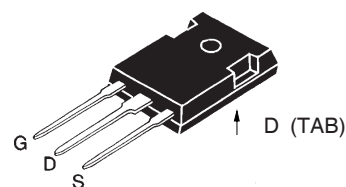

TO-268 (IXTT)

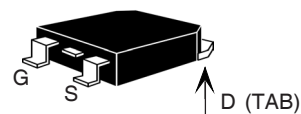

G = Gate, D = Drain,
S = Source, TAB = Drain

Features

- International standard packages
- Low $R_{DS(on)}$ HDMOS™ process
- Rugged polysilicon gate cell structure
- Unclamped Inductive Switching (UIS) rated
- Low package inductance (<5 nH)
- easy to drive and to protect

Applications

- High side switching
- Push-pull amplifiers
- DC choppers
- Automatic test equipment

Advantages

- Easy to mount with 1 screw
(isolated mounting screw hole)
- Space savings
- High power density

Symbol	Test Conditions	Characteristic Values ($T_J = 25^\circ\text{C}$, unless otherwise specified)		
		min.	typ.	max.
V_{DSS}	$V_{GS} = 0 \text{ V}$, $I_D = -250 \text{ } \mu\text{A}$	-200		V
$V_{GS(th)}$	$V_{DS} = V_{GS}$, $I_D = -250 \text{ } \mu\text{A}$	-3.0		V
I_{GSS}	$V_{GS} = \pm 20 \text{ V}_{DC}$, $V_{DS} = 0$			$\pm 100 \text{ nA}$
I_{DSS}	$V_{DS} = 0.8 \cdot V_{DSS}$ $V_{GS} = 0 \text{ V}$	$T_J = 25^\circ\text{C}$		-25 μA
		$T_J = 125^\circ\text{C}$		-1 mA
$R_{DS(on)}$	$V_{GS} = -10 \text{ V}$, $I_D = 0.5 \cdot I_{D25}$			0.15 Ω

Symbol	Test Conditions	Characteristic Values ($T_J = 25^\circ\text{C}$, unless otherwise specified)		
		min.	typ.	max.
g_{fs}	$V_{DS} = -10\text{ V}$; $I_D = I_{D25}$, pulse test	10	15	S
C_{iss}	$V_{GS} = 0\text{ V}$, $V_{DS} = -25\text{ V}$, $f = 1\text{ MHz}$		4200	pF
C_{oss}			830	pF
C_{rss}			350	pF
$t_{d(on)}$	$V_{GS} = -10\text{ V}$, $V_{DS} = 0.5 V_{DSS}$, $I_D = 0.5 I_{D25}$ $R_G = 4.7\ \Omega$ (External)		36	ns
t_r			29	ns
$t_{d(off)}$			68	ns
t_f			28	ns
$Q_{g(on)}$	$V_{GS} = -10\text{ V}$, $V_{DS} = 0.5 V_{DSS}$, $I_D = 0.5 I_{D25}$		150	nC
Q_{gs}			40	nC
Q_{gd}			70	nC
R_{thJC}	(TO-247)		0.42	K/W
R_{thCS}			0.25	K/W

Symbol	Test Conditions	Characteristic Values ($T_J = 25^\circ\text{C}$, unless otherwise specified)		
		min.	typ.	max.
I_S	$V_{GS} = 0$			-24 A
I_{SM}	Repetitive; pulse width limited by T_{JM}			-96 A
V_{SD}	$I_F = I_S$, $V_{GS} = 0\text{ V}$, Pulse test, $t \leq 300\ \mu\text{s}$, duty cycle $d \leq 2\%$			-3 V
t_{rr}	$I_F = I_S$, $di/dt = 100\text{ A}/\mu\text{s}$, $V_R = -50\text{ V}$		250	ns

TO-247 (IXTH) Outline

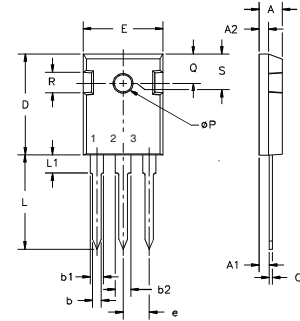

Terminals: 1 - Gate 2 - Drain
3 - Source Tab - Drain

Dim.	Millimeter		Inches	
	Min.	Max.	Min.	Max.
A	4.7	5.3	.185	.209
A ₁	2.2	2.54	.087	.102
A ₂	2.2	2.6	.059	.098
b	1.0	1.4	.040	.055
b ₁	1.65	2.13	.065	.084
b ₂	2.87	3.12	.113	.123
C	.4	.8	.016	.031
D	20.80	21.46	.819	.845
E	15.75	16.26	.610	.640
e	5.20	5.72	0.205	0.225
L	19.81	20.32	.780	.800
L ₁		4.50		.177
∅P	3.55	3.65	.140	.144
Q	5.89	6.40	0.232	0.252
R	4.32	5.49	.170	.216
S	6.15	BSC	.242	BSC

TO-268 (IXTT) Outline

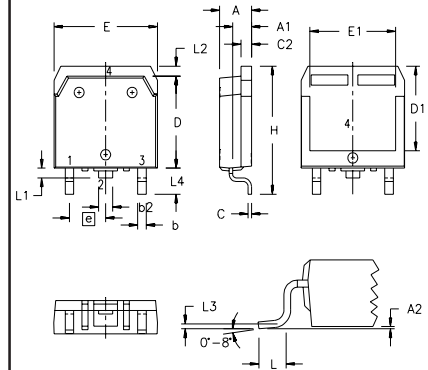

SYM	INCHES		MILLIMETERS	
	MIN	MAX	MIN	MAX
A	.193	.201	4.90	5.10
A ₁	.106	.114	2.70	2.90
A ₂	.001	.010	0.02	0.25
b	.045	.057	1.15	1.45
b ₂	.075	.083	1.90	2.10
C	.016	.026	0.40	0.65
C ₂	.057	.063	1.45	1.60
D	.543	.551	13.80	14.00
D ₁	.488	.500	12.40	12.70
E	.624	.632	15.85	16.05
E ₁	.524	.535	13.30	13.60
e	.215	BSC	5.45	BSC
H	.736	.752	18.70	19.10
L	.094	.106	2.40	2.70
L ₁	.047	.055	1.20	1.40
L ₂	.039	.045	1.00	1.15
L ₃	.010	BSC	0.25	BSC
L ₄	.150	.161	3.80	4.10

IXYS reserves the right to change limits, test conditions, and dimensions.

IXYS MOSFETs and IGBTs are covered by one or more of the following U.S. patents:	4,835,592	4,931,844	5,049,961	5,237,481	6,162,665	6,404,065 B1	6,683,344	6,727,585
	4,850,072	5,017,508	5,063,307	5,381,025	6,259,123 B1	6,534,343	6,710,405 B2	6,759,692
	4,881,106	5,034,796	5,187,117	5,486,715	6,306,728 B1	6,583,505	6,710,463	6,771,478 B2

Fig. 1. Output Characteristics @ 25°C

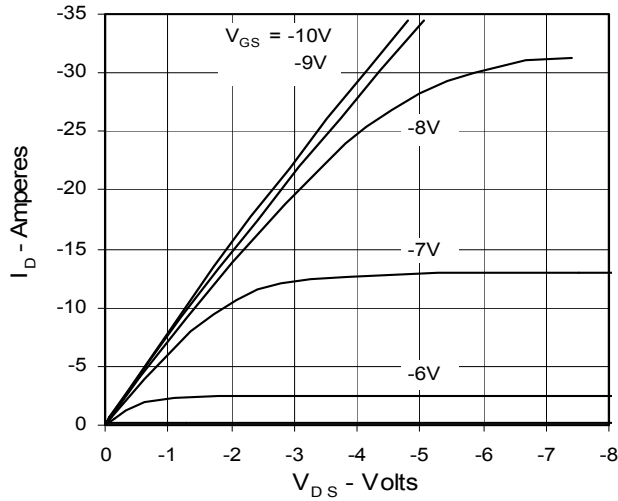

Fig. 2. Output Characteristics @ 125°C

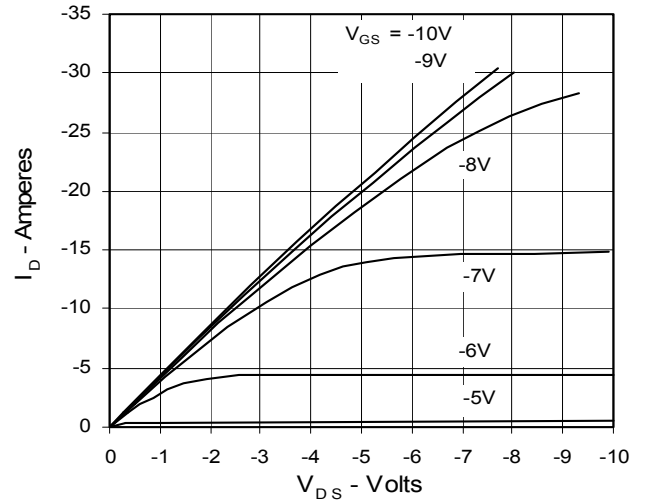

Fig. 3. $R_{DS(on)}$ Normalized to I_{D25} Value vs. Junction Temperature

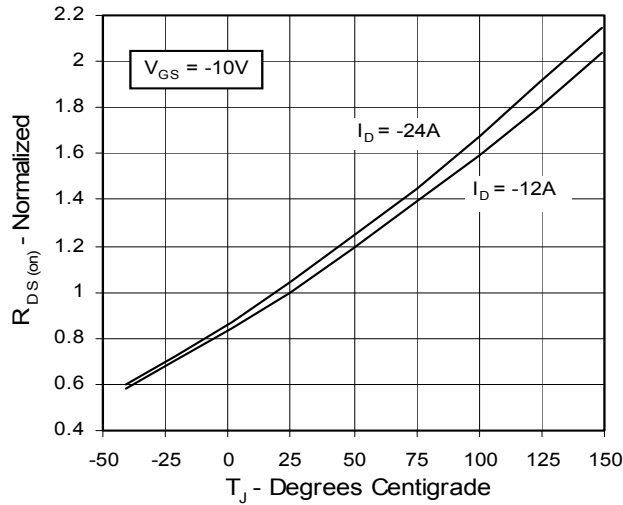

Fig. 4. $R_{DS(on)}$ Normalized to I_{D25} Value vs. I_D

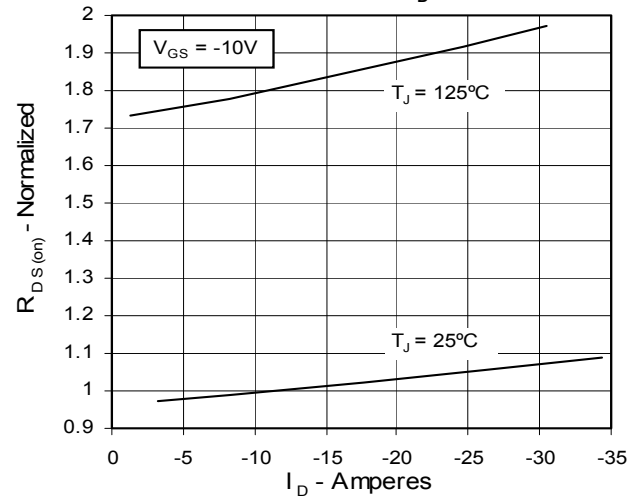

Fig. 5. Drain Current vs. Case Temperature

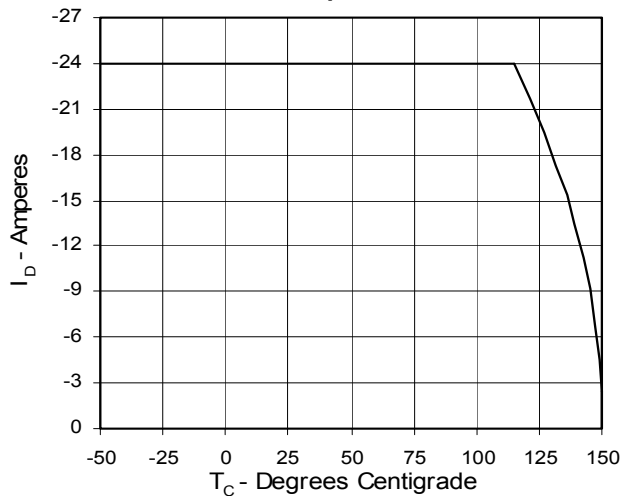

Fig. 6. Input Admittance

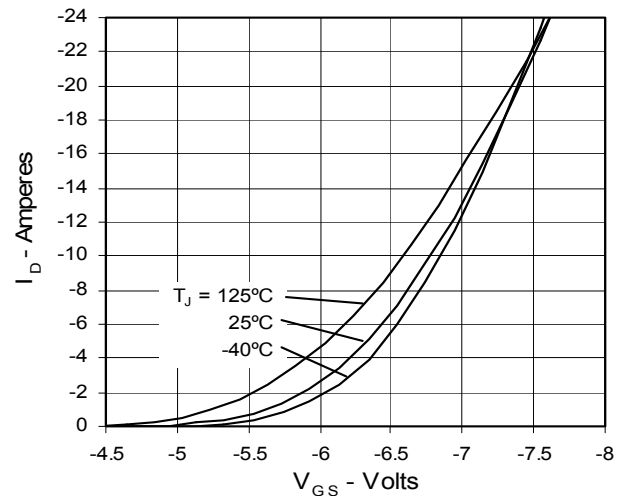

Fig. 7. Transconductance

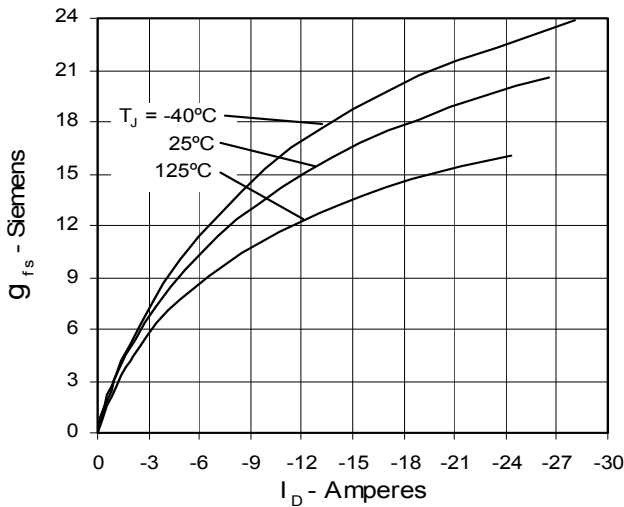

Fig. 8. Source Current vs. Source-To-Drain Voltage

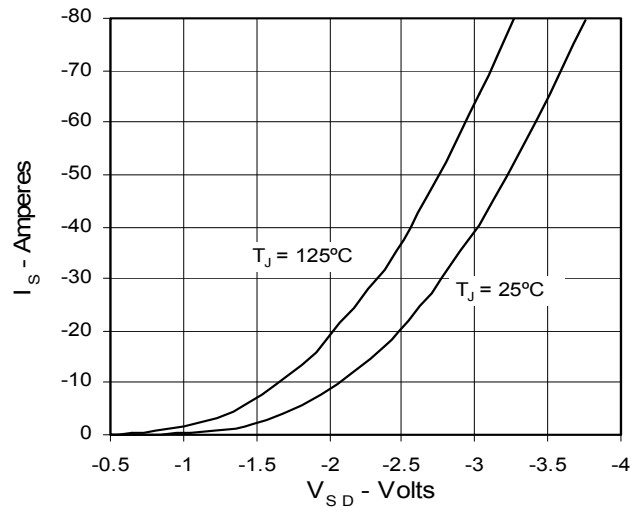

Fig. 9. Gate Charge

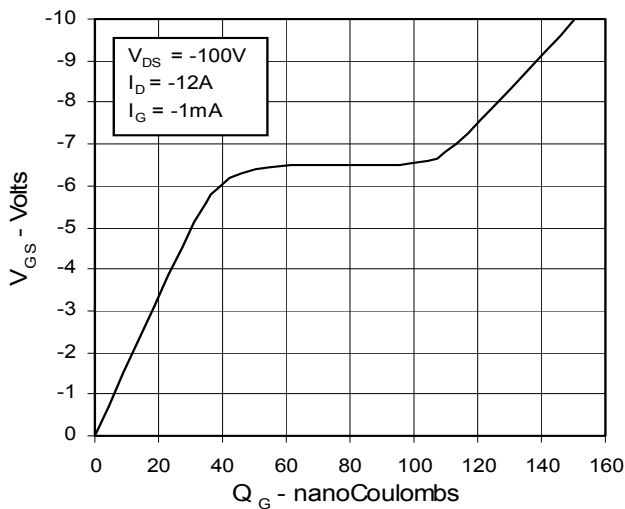

Fig. 10. Temperature dependence of Breakdown and Threshold Voltage

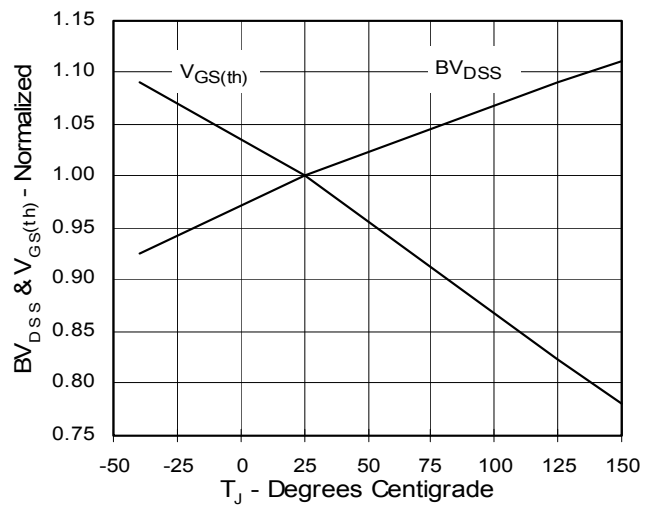

Fig. 11. Capacitance

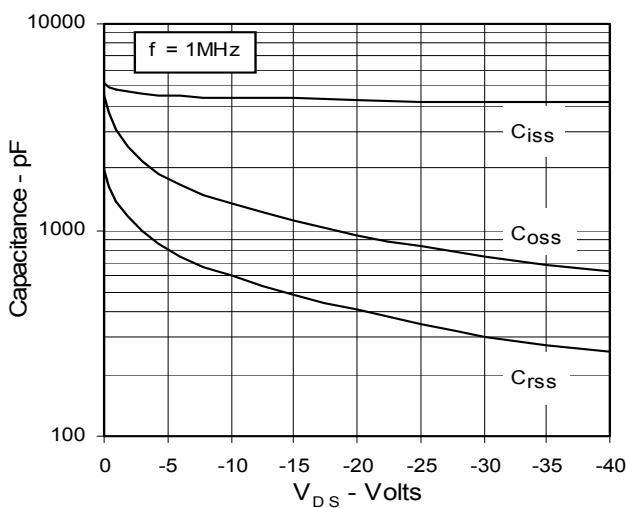

Fig. 12. Forward-Bias Safe Operating Area

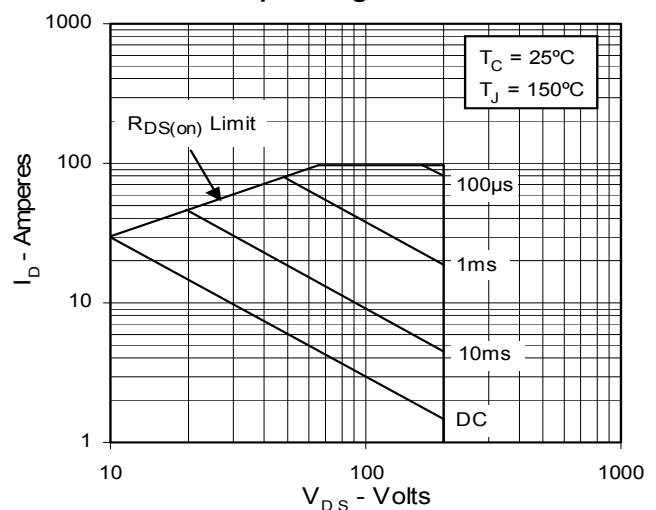
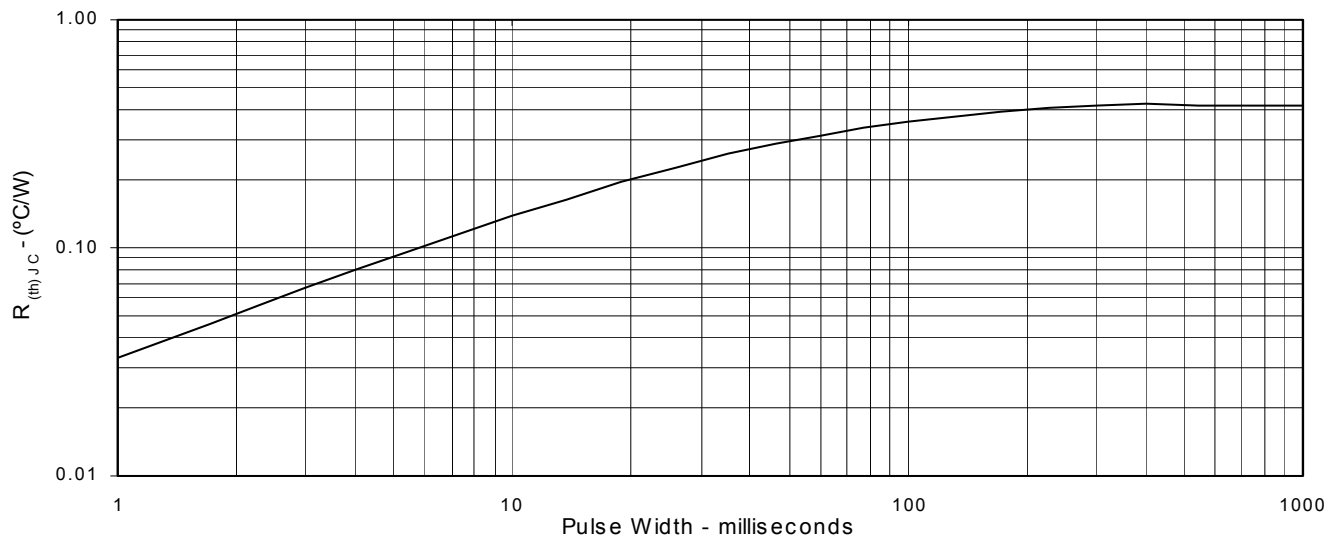

Fig. 13. Maximum Transient Thermal Resistance





Disclaimer Notice - Information furnished is believed to be accurate and reliable. However, users should independently evaluate the suitability of and test each product selected for their own applications. Littelfuse products are not designed for, and may not be used in, all applications. Read complete Disclaimer Notice at www.littelfuse.com/disclaimer-electronics.