

# Standard Rectifier

$$V_{RRM} = 2 \times 1200 \text{ V}$$

$$I_{FAV} = 10 \text{ A}$$

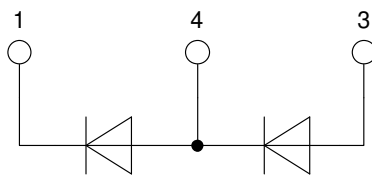
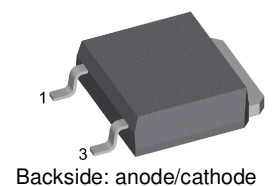
$$V_F = 1.27 \text{ V}$$

Phase leg

Part number

**DMA10P1200UZ**

Marking on Product: MATMZP



### Features / Advantages:

- Planar passivated chips
- Very low leakage current
- Very low forward voltage drop
- Improved thermal behaviour
- High commutation robustness
- High surge capability

### Applications:

- Diode for main rectification
- For single and three phase bridge configurations

### Package: TO-252 (DPak)

- Industry standard outline
- RoHS compliant
- Epoxy meets UL 94V-0
- High creepage distance between terminals

### Disclaimer Notice

Information furnished is believed to be accurate and reliable. However, users should independently evaluate the suitability of and test each product selected for their own applications. Littelfuse products are not designed for, and may not be used in, all applications. Read complete Disclaimer Notice at [www.littelfuse.com/disclaimer-electronics](http://www.littelfuse.com/disclaimer-electronics).

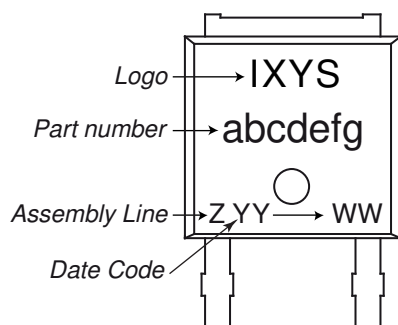


Rectifier				Ratings			
Symbol	Definition	Conditions	min.	typ.	max.	Unit	
$V_{RSM}$	max. non-repetitive reverse blocking voltage	$T_{VJ} = 25^{\circ}C$			1300	V	
$V_{RRM}$	max. repetitive reverse blocking voltage	$T_{VJ} = 25^{\circ}C$			1200	V	
$I_R$	reverse current	$V_R = 1200 V$	$T_{VJ} = 25^{\circ}C$		5	$\mu A$	
		$V_R = 1200 V$	$T_{VJ} = 150^{\circ}C$		0.05	mA	
$V_F$	forward voltage drop	$I_F = 5 A$	$T_{VJ} = 25^{\circ}C$		1.29	V	
		$I_F = 10 A$			1.55	V	
		$I_F = 5 A$	$T_{VJ} = 150^{\circ}C$		1.27	V	
		$I_F = 10 A$			1.63	V	
$I_{FAV}$	average forward current	$T_C = 140^{\circ}C$ 180° sine	$T_{VJ} = 175^{\circ}C$		10	A	
$V_{FO}$	threshold voltage	} for power loss calculation only	$T_{VJ} = 175^{\circ}C$		0.90	V	
$r_F$	slope resistance				37	m $\Omega$	
$R_{thJC}$	thermal resistance junction to case				2	K/W	
$R_{thCH}$	thermal resistance case to heatsink			0.5		K/W	
$P_{tot}$	total power dissipation		$T_C = 25^{\circ}C$		75	W	
$I_{FSM}$	max. forward surge current	t = 10 ms; (50 Hz), sine	$T_{VJ} = 45^{\circ}C$		100	A	
		t = 8,3 ms; (60 Hz), sine	$V_R = 0 V$		110	A	
		t = 10 ms; (50 Hz), sine	$T_{VJ} = 150^{\circ}C$		85	A	
		t = 8,3 ms; (60 Hz), sine	$V_R = 0 V$		92	A	
$I^2t$	value for fusing	t = 10 ms; (50 Hz), sine	$T_{VJ} = 45^{\circ}C$		50	A <sup>2</sup> s	
		t = 8,3 ms; (60 Hz), sine	$V_R = 0 V$		50	A <sup>2</sup> s	
		t = 10 ms; (50 Hz), sine	$T_{VJ} = 150^{\circ}C$		36	A <sup>2</sup> s	
		t = 8,3 ms; (60 Hz), sine	$V_R = 0 V$		35	A <sup>2</sup> s	
$C_J$	junction capacitance	$V_R = 400 V; f = 1 MHz$	$T_{VJ} = 25^{\circ}C$		1	pF	



Package TO-252 (DPak)			Ratings			
Symbol	Definition	Conditions	min.	typ.	max.	Unit
$I_{RMS}$	RMS current	per terminal			20	A
$T_{VJ}$	virtual junction temperature		-55		175	°C
$T_{op}$	operation temperature		-55		150	°C
$T_{stg}$	storage temperature		-55		150	°C
<b>Weight</b>				0.3		g
$F_C$	mounting force with clip		20		60	N
$d_{Spp/App}$	creepage distance on surface / striking distance through air	terminal to terminal	3.6			mm
$d_{Spb/Apb}$		terminal to backside	3.0			mm

**Product Marking**



**Part description**

- D = Diode
- M = Standard Rectifier
- A = (up to 1800V)
- 10 = Current Rating [A]
- P = Phase leg
- 1200 = Reverse Voltage [V]
- UZ = TO-252AA (DPak) (2HV)

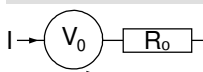
Ordering	Ordering Number	Marking on Product	Delivery Mode	Quantity	Code No.
Standard	DMA10P1200UZ-TRL	MATMZP	Tape & Reel	2500	524603
Alternative	DMA10P1200UZ-TUB	MATMZP	Tube	70	524596

Similar Part	Package	Voltage class
DMA10P1600UZ	TO-252AA (DPak) (2HV)	1600

**Equivalent Circuits for Simulation**

*\* on die level*

$T_{VJ} = 175\text{°C}$

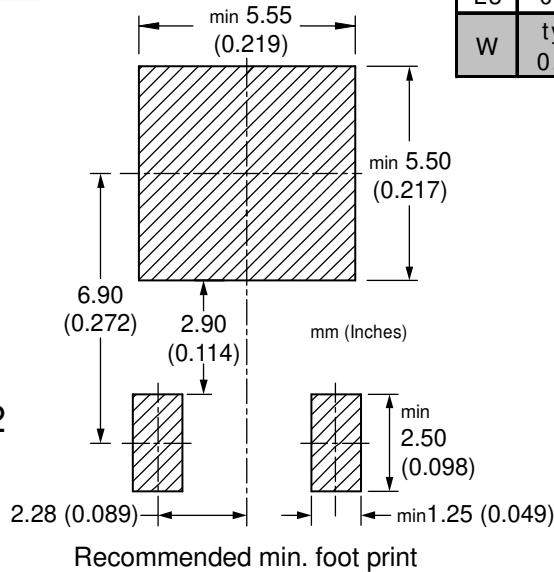
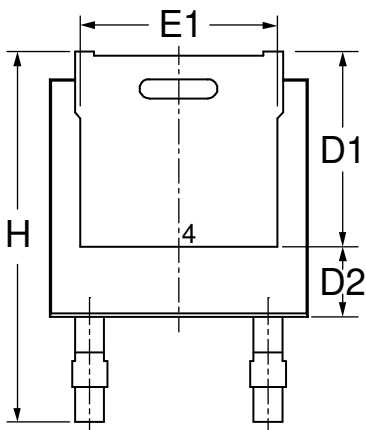
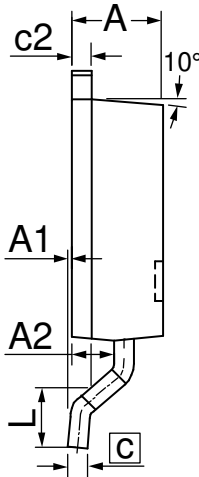
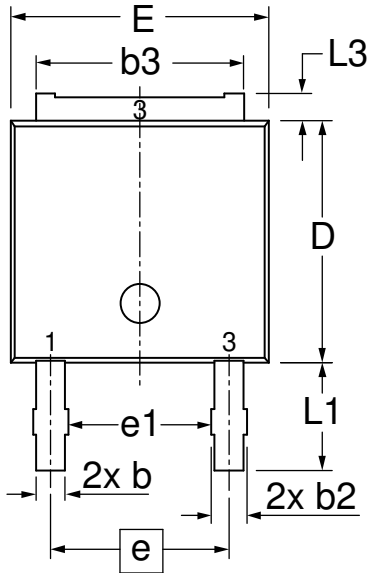
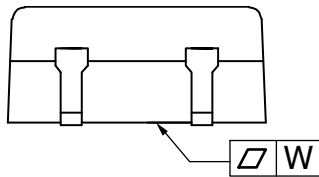


**Rectifier**

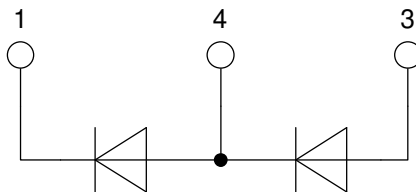
$V_{0\ max}$	threshold voltage	0.9	V
$R_{0\ max}$	slope resistance *	34	mΩ



**Outlines TO-252 (DPak)**



Dim	Millimeters		Inches	
	min	max	min	max
A	2.18	2.39	0.086	0.094
A1	0.00	0.13	0.000	0.005
A2	0.97	1.17	0.038	0.046
b	0.64	0.89	0.025	0.035
b2	0.76	1.14	0.030	0.045
b3	5.08	5.59	0.200	0.220
c	0.46	0.61	0.018	0.024
c2	0.46	0.58	0.018	0.023
D	5.97	6.22	0.235	0.245
D1	4.57	5.21	0.180	0.205
D2	2.03		0.080	
E	6.35	6.73	0.250	0.265
E1	4.32	5.21	0.170	0.205
e	4.57		0.180	
e1	3.62		0.143	
H	9.15	10.34	0.360	0.407
L	1.40	1.78	0.055	0.070
L1	2.54	2.92	0.100	0.115
L3	0.64	1.02	0.025	0.040
W	typ. 0.02	0.040	typ. 0.0008	0.000



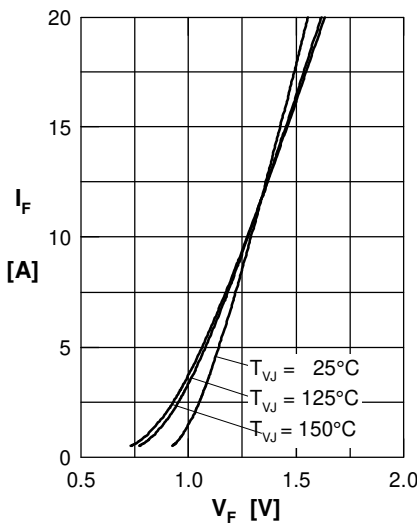
**Rectifier**


Fig. 1 Forward current versus voltage drop per diode

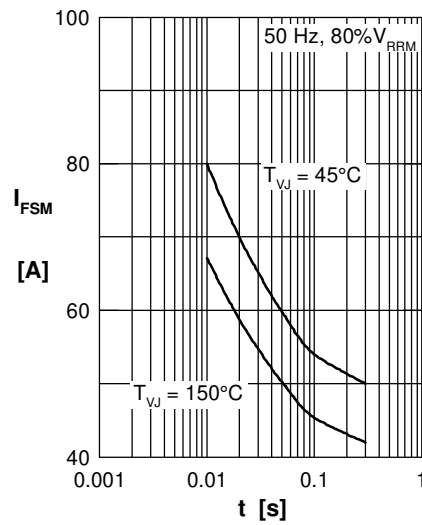


Fig. 2 Surge overload current

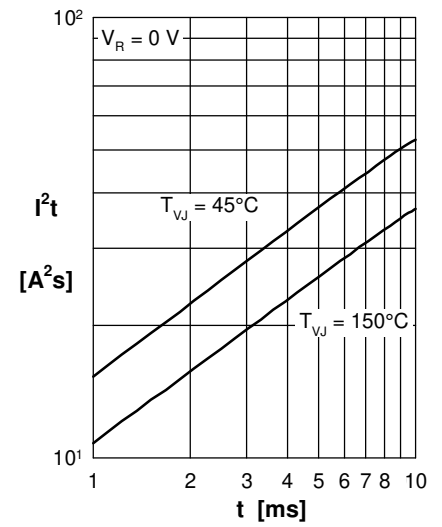
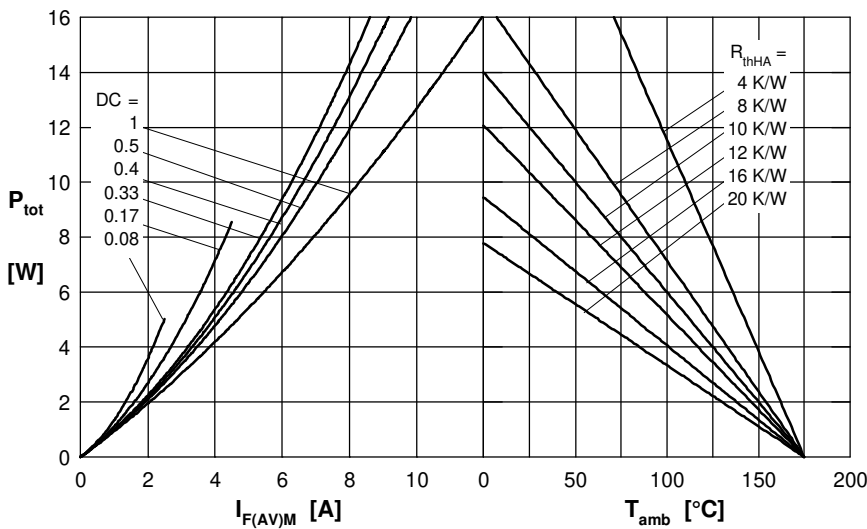

 Fig. 3  $I^2t$  versus time per diode


Fig. 4 Power dissipation vs. direct output current and ambient temperature

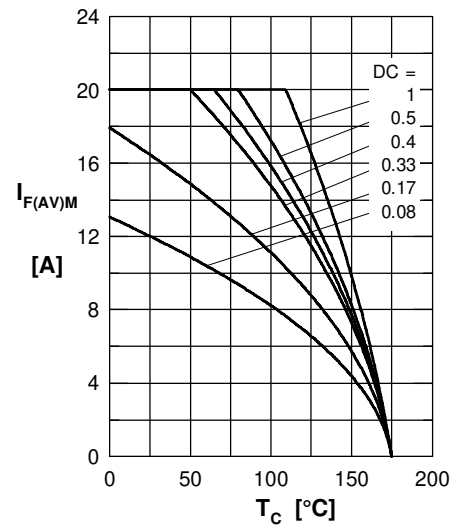


Fig. 5 Max. forward current vs. case temperature

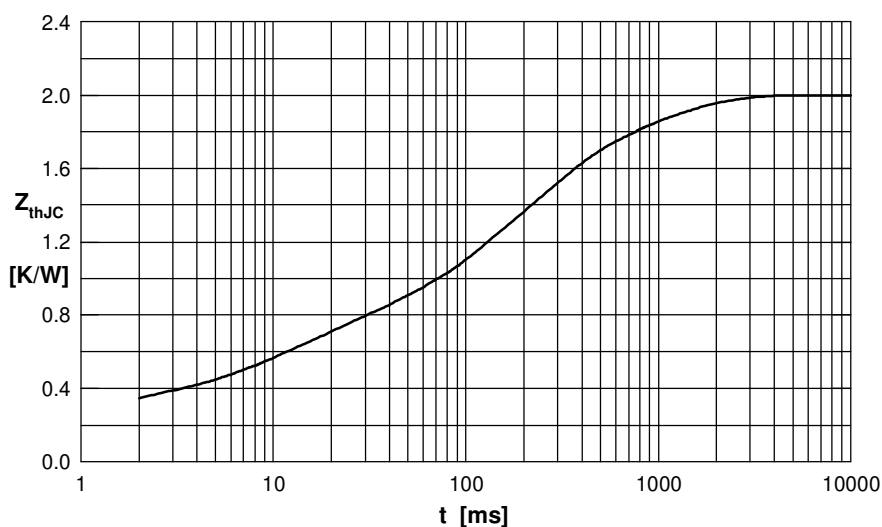


Fig. 6 Transient thermal impedance junction to case

 Constants for  $Z_{thJC}$  calculation:

i	$R_{thi}$ (K/W)	$t_i$ (s)
1	0.275	0.0005
2	0.385	0.0105
3	0.880	0.1700
4	0.460	0.8500