

Qxx25xx & Qxx25xHx Series



Agency Approval

| Agency | Agency File Number |
|--------|--------------------|
| | E71639* |

* - Only Package Types TO-220L, TO-218K and TO-218J

Main Features

| Symbol | Value | Unit |
|-------------------|----------|------|
| $I_{T(RMS)}$ | 25 | A |
| V_{DRM}/V_{RRM} | 1000 | V |
| I_{GT} | 50 or 80 | mA |

Schematic Symbol



Description

This 25 Amp bi-directional solid state switch series is designed for AC switching and phase control applications such as motor speed and temperature modulation controls, lighting controls, and static switching relays.

Standard alternistor triac components operate with in-phase signals in Quadrants I or III and ONLY unipolar negative gate pulses for Quadrant II or III. The alternistor triac will not operate in Quadrant IV.

Features & Benefits

- RoHS compliant
- Glass – passivated junctions
- Voltage capability up to 1000 V
- Surge capability up to 250A at 60 Hz half cycle

Applications

Excellent for AC switching and phase control applications such as heating, lighting, and motor speed controls.

Typical applications are AC solid-state switches, industrial power tools, exercise equipment, white goods and commercial appliances.

Alternistor Triacs (no snubber required) are used in applications with high inductive loads requiring the highest commutation performance.

Internally constructed isolated packages are offered for ease of heat sinking with highest isolation voltage.

Additional Information



Absolute Maximum Ratings – Standard Triac

| Symbol | Parameter | Test Conditions | Value | Unit |
|--------------|---|---|------------|------------------|
| $I_{T(RMS)}$ | RMS on-state current | Qxx25R5 Qxx25N5 Qxx25L5 $T_c = 65^\circ\text{C}$ $T_c = 95^\circ\text{C}$ | 25 | A |
| I_{TSM} | Peak non-repetitive surge current | Qxx25R5 Qxx25N5 Qxx25L5 full cycle; f = 50Hz; T_J (initial) = 25°C | 167 | A |
| | | full cycle; f = 60Hz; T_J (initial) = 25°C | 200 | |
| I^2t | I^2t Value for fusing | Qxx25R5 Qxx25N5 Qxx25L5 $t_p = 8.3\text{ms}$ | 166 | A ² s |
| di/dt | Critical rate-of-rise of on-state current | f = 60Hz; $T_J = 125^\circ\text{C}$ | 100 | A/ μs |
| I_{GTM} | Peak gate current | $t_p = 20\mu\text{s}$, $T_J = 125^\circ\text{C}$ | 4 | A |
| $P_{G(AV)}$ | Average gate power dissipation | $T_J = 125^\circ\text{C}$ | 0.5 | W |
| T_{stg} | Storage temperature range | | -40 to 125 | °C |
| T_J | Operating junction temperature range | Qxx25R5 Qxx25N5 Qxx25L5 | -40 to 125 | °C |

Absolute Maximum Ratings – Alternistor Triac

| Symbol | Parameter | Test Conditions | Value | Unit |
|--------------|---|---|------------|------------------|
| $I_{T(RMS)}$ | RMS on-state current | Qxx25LH5 Qxx25L6 $T_c = 65^\circ\text{C}$ | 25 | A |
| | | Qxx25K6 Qxx25J6 $T_c = 85^\circ\text{C}$ | | |
| | | Qxx25RH5 Qxx25NH5 Qxx25R6 Qxx25NH6 $T_c = 95^\circ\text{C}$ | | |
| I_{TSM} | Peak non-repetitive surge current | full cycle; f = 50Hz; T_J (initial) = 25°C | 208 | A |
| | | full cycle; f = 60Hz; T_J (initial) = 25°C | 250 | |
| I^2t | I^2t Value for fusing | $t_p = 8.3\text{ms}$ | 260 | A ² s |
| di/dt | Critical rate-of-rise of on-state current | f = 60Hz; $T_J = 125^\circ\text{C}$ | 100 | A/ μs |
| I_{GTM} | Peak gate current | $t_p = 20\mu\text{s}$, $T_J = 125^\circ\text{C}$ | 4 | A |
| $P_{G(AV)}$ | Average gate power dissipation | $T_J = 125^\circ\text{C}$ | 0.5 | W |
| T_{stg} | Storage temperature range | | -40 to 125 | °C |
| T_J | Operating junction temperature range | | -40 to 125 | °C |

Note: xx = voltage/10

Electrical Characteristics ($T_J = 25^\circ\text{C}$, unless otherwise specified) — Standard Triac

| Symbol | Test Conditions | Quadrant | | Value | | Unit |
|------------|---|--------------------|--------------|-------------------------------|--|------------------|
| | | | | Qxx25R5 Qxx25N5 Qxx25L5 | | |
| I_{GT} | $V_D = 12\text{V}; R_L = 60\ \Omega$ | I – II – III IV | MAX. TYP. | 50 120 | | mA |
| V_{GT} | $V_D = 12\text{V}; R_L = 60\ \Omega$ | I – II – III IV | MAX. TYP. | 1.3 2.5 | | V |
| V_{GD} | $V_D = V_{DRM}; R_L = 3.3\ \text{k}\Omega; T_J = 125^\circ\text{C}$ | ALL | MIN. | 0.2 | | V |
| I_H | $I_T = 400\text{mA}$ (initial) | | MAX. | 100 | | mA |
| dv/dt | $V_D = V_{DRM};$ Gate Open; $T_J = 125^\circ\text{C}$ | 400V | MIN. | 275 | | V/ μs |
| | | 600V | | 225 | | |
| | | 800V | | 200 | | |
| | | 1000V | | 200 | | |
| $(dv/dt)c$ | $(di/dt)c = 13.3\ \text{A/ms}; T_J = 125^\circ\text{C}$ | | MIN. | 5 | | V/ μs |
| | | | TYP. | 4 | | μs |
| t_{gt} | $I_G = 2 \times I_{GT}; PW = 15\ \mu\text{s}; I_T = 35.4\ \text{A}$ | | TYP. | 4 | | μs |

Electrical Characteristics ($T_J = 25^\circ\text{C}$, unless otherwise specified) — Alternistor Triac

| Symbol | Test Conditions | Quadrant | | Value | | Unit |
|------------|---|--------------|------|----------------------------------|--|------------------|
| | | | | Qxx25RH5 Qxx25LH5 Qxx25NH5 | Qxx25R6 Qxx25L6 Qxx25NH6 Qxx25K6 Qxx25J6 | |
| I_{GT} | $V_D = 12\text{V}; R_L = 60\ \Omega$ | I – II – III | MAX. | 50 | 80 | mA |
| V_{GT} | $V_D = 12\text{V}; R_L = 60\ \Omega$ | I – II – III | MAX. | 1.3 | | V |
| V_{GD} | $V_D = V_{DRM}; R_L = 3.3\ \text{k}\Omega; T_J = 125^\circ\text{C}$ | I – II – III | MIN. | 0.2 | | V |
| I_H | $I_T = 400\text{mA}$ (initial) | | MAX. | 50 | 100 | mA |
| dv/dt | $V_D = V_{DRM};$ Gate Open; $T_J = 125^\circ\text{C}$ | 400V | MIN. | 575 | 600 | V/ μs |
| | | 600V | | 500 | 600 | |
| | | 800V | | 400 | 475 | |
| | | 1000V | | - | 400 | |
| $(dv/dt)c$ | $(di/dt)c = 13.3\ \text{A/ms}; T_J = 125^\circ\text{C}$ | | MIN. | 20 | 30 | V/ μs |
| | | | TYP. | 3 | 5 | μs |
| t_{gt} | $I_G = 2 \times I_{GT}; PW = 15\ \mu\text{s}; I_T = 35.4\ \text{A}$ | | TYP. | 3 | 5 | μs |

Static Characteristics

| Symbol | Test Conditions | | Quadrant | | Value | | Unit |
|---------------------|--|---------------------------|---------------------|------|--|--|---------------|
| | | | | | Qxx25R5 Qxx25N5 Qxx25xH5 Qxx25x6 Qxx25NH6 Qxx25L5 | | |
| V_{TM} | $I_T = 35.4\text{A}; t_p = 380\ \mu\text{s}$ | | | MAX. | 1.8 | | V |
| I_{DRM} / I_{RRM} | V_{DRM} / V_{RRM} | $T_J = 25^\circ\text{C}$ | 400 - 800V 1000V | MAX. | 10 20 | | μA |
| | | $T_J = 100^\circ\text{C}$ | 400 - 800V 1000V | | 500 1000 | | |
| | | $T_J = 125^\circ\text{C}$ | 400 - 800V | | 2000 | | |

Note: xx = voltage/10, x = package

Thermal Resistances

| Symbol | Parameter | Value | Unit | |
|-------------------|-----------------------|--|------|------|
| $R_{\theta(J-C)}$ | Junction to case (AC) | Qxx25R5 / Qxx25N5 Qxx25R6 / Qxx25NH6 Qxx25RH5 / Qxx25NH5 | 0.89 | °C/W |
| | | Qxx25L6 / Qxx25LH5 / Qxx25L5 | 2.0 | |
| | | Qxx25K6 / Qxx25J6 | 1.32 | |
| $R_{\theta(J-A)}$ | Junction to ambient | Qxx25Ry | 45 | °C/W |
| | | Qxx25L6 / Qxx25LH5 / Qxx25L5 | 50 | |

Note: xx = voltage/10, y = sensitivity

Figure 1: Normalized DC Gate Trigger Current vs. Junction Temperature

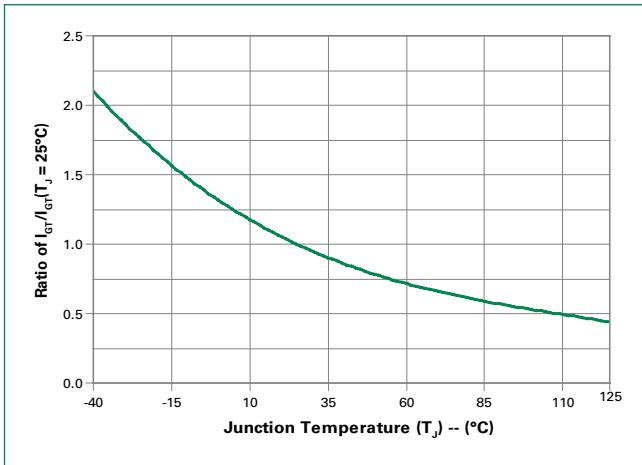

Figure 2: Normalized DC Gate Trigger Voltage vs. Junction Temperature



Figure 3: Normalized DC Holding Current vs. Junction Temperature

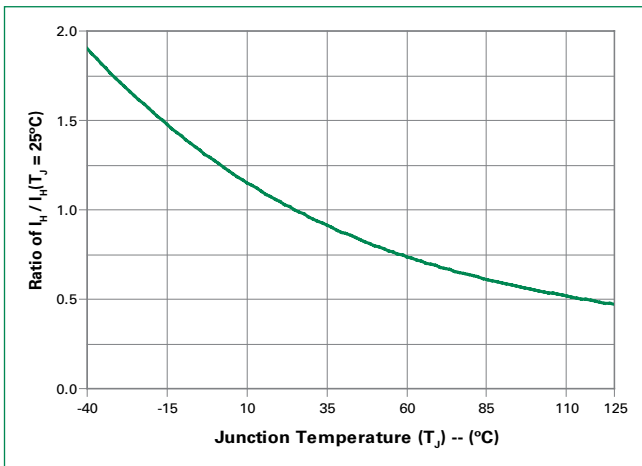

Figure 4: On-State Current vs. On-State Voltage (Typical)



Figure 5: Power Dissipation (Typical) vs. RMS On-State Current



Figure 6: Maximum Allowable Case Temperature vs. RMS On-State Current



Figure 7: Maximum Allowable Ambient Temperature vs. RMS On-State Current (TO-220 packages only)

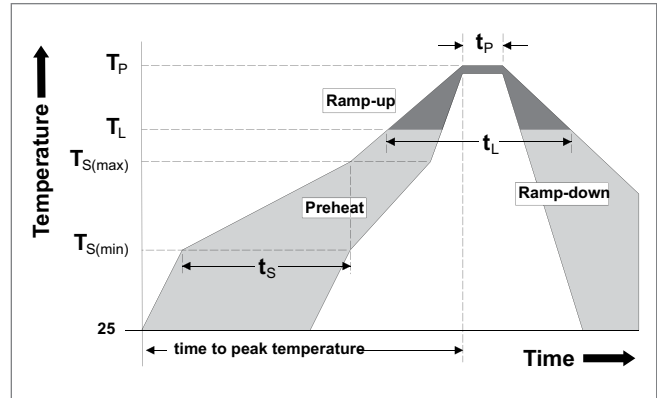

Figure 8: Surge Peak On-State Current vs. Number of Cycles



Soldering Parameters

| | | |
|--|------------------------------------|-------------------------|
| Reflow Condition | | Pb – Free assembly |
| Pre Heat | - Temperature Min ($T_{s(min)}$) | 150°C |
| | - Temperature Max ($T_{s(max)}$) | 200°C |
| | - Time (min to max) (t_s) | 60 – 180 secs |
| Average ramp up rate (Liquidus Temp) (T_L) to peak | | 5°C/second max |
| $T_{s(max)}$ to T_L - Ramp-up Rate | | 5°C/second max |
| Reflow | - Temperature (T_L) (Liquidus) | 217°C |
| | - Temperature (t_L) | 60 – 150 seconds |
| Peak Temperature (T_p) | | 260 ^{+0/-5} °C |
| Time within 5°C of actual peak Temperature (t_p) | | 20 – 40 seconds |
| Ramp-down Rate | | 5°C/second max |
| Time 25°C to peak Temperature (T_p) | | 8 minutes Max. |
| Do not exceed | | 280°C |



Physical Specifications

| | |
|------------------------|--|
| Terminal Finish | 100% Matte Tin-plated |
| Body Material | UL Recognized compound meeting flammability rating V-0 |
| Lead Material | Copper Alloy |

Design Considerations

Careful selection of the correct component for the application's operating parameters and environment will go a long way toward extending the operating life of the Thyristor. Good design practice should limit the maximum continuous current through the main terminals to 75% of the device rating. Other ways to ensure long life for a power discrete semiconductor are proper heat sinking and selection of voltage ratings for worst case conditions. Overheating, overvoltage (including dv/dt), and surge currents are the main killers of semiconductors. Correct mounting, soldering, and forming of the leads also help protect against component damage.

Environmental Specifications

| Test | Specifications and Conditions |
|--|--|
| High Temperature Voltage Blocking | MIL-STD-750: Method 1040, Condition A Rated V_{RRM} , 125°C, 1008 hours |
| Temperature Cycling | MIL-STD-750: Method 1051 -40°C to 125°C, 15-minute dwell, 100 cycles |
| Biased Temp & Humidity | EIA/JEDEC: JESD22-A101 320VDC, 85°C, 85%RH, 1008 hours |
| High Temp. Storage | MIL-STD-750: Method 1031 150°C, 1008 hours |
| Low-Temp Storage | -40°C, 1008 hours |
| Resistance to Solder Heat | MIL-STD-750: Method 2031 260°C, 10 seconds |
| Solderability | ANSI/J-STD-002, Category 3, Test A |
| Lead Bend | MIL-STD-750: Method 2036, Condition E |

Dimensions — TO-220AB (R Package) — Non-isolated Mounting Tab



| Dimension | Inches | | Millimeters | |
|-----------|--------|-------|-------------|-------|
| | Min | Max | Min | Max |
| A | 0.380 | 0.420 | 9.65 | 10.67 |
| B | 0.105 | 0.115 | 2.67 | 2.92 |
| C | 0.230 | 0.250 | 5.84 | 6.35 |
| D | 0.590 | 0.620 | 14.99 | 15.75 |
| E | 0.142 | 0.147 | 3.61 | 3.73 |
| F | 0.110 | 0.130 | 2.79 | 3.30 |
| G | 0.540 | 0.575 | 13.72 | 14.61 |
| H | 0.025 | 0.035 | 0.64 | 0.89 |
| J | 0.195 | 0.205 | 4.95 | 5.21 |
| K | 0.095 | 0.105 | 2.41 | 2.67 |
| L | 0.060 | 0.075 | 1.52 | 1.91 |
| M | 0.085 | 0.095 | 2.16 | 2.41 |
| N | 0.018 | 0.024 | 0.46 | 0.61 |
| O | 0.178 | 0.188 | 4.52 | 4.78 |
| P | 0.045 | 0.060 | 1.14 | 1.52 |
| R | 0.038 | 0.048 | 0.97 | 1.22 |

Dimensions — TO-220AB (L Package) — Isolated Mounting Tab



| Dimension | Inches | | Millimeters | |
|-----------|--------|-------|-------------|-------|
| | Min | Max | Min | Max |
| A | 0.380 | 0.420 | 9.65 | 10.67 |
| B | 0.105 | 0.115 | 2.66 | 2.92 |
| C | 0.230 | 0.250 | 5.85 | 6.35 |
| D | 0.590 | 0.620 | 14.98 | 15.75 |
| E | 0.142 | 0.147 | 3.61 | 3.73 |
| F | 0.110 | 0.130 | 2.80 | 3.30 |
| G | 0.540 | 0.575 | 13.71 | 14.60 |
| H | 0.025 | 0.035 | 0.63 | 0.89 |
| J | 0.195 | 0.205 | 4.95 | 5.21 |
| K | 0.095 | 0.105 | 2.41 | 2.67 |
| L | 0.060 | 0.075 | 1.52 | 1.91 |
| M | 0.085 | 0.095 | 1.78 | 2.16 |
| N | 0.018 | 0.024 | 0.45 | 0.61 |
| O | 0.178 | 0.188 | 4.52 | 4.78 |
| P | 0.045 | 0.060 | 1.14 | 1.53 |
| R | 0.038 | 0.048 | 0.97 | 1.22 |

Dimensions — TO-263 (N Package) — D²Pak Surface Mount

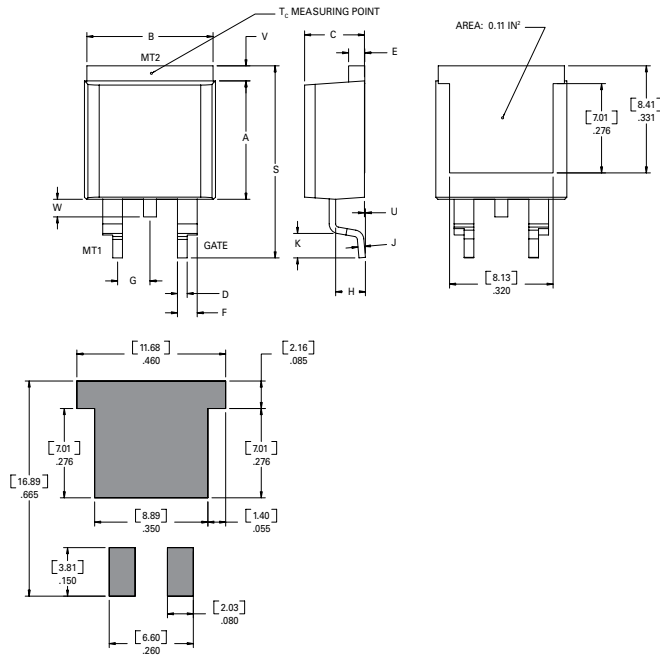

| Dimension | Inches | | Millimeters | |
|-----------|--------|-------|-------------|-------|
| | Min | Max | Min | Max |
| A | 0.360 | 0.370 | 9.14 | 9.40 |
| B | 0.380 | 0.420 | 9.65 | 10.67 |
| C | 0.178 | 0.188 | 4.52 | 4.78 |
| D | 0.025 | 0.035 | 0.64 | 0.89 |
| E | 0.045 | 0.060 | 1.14 | 1.52 |
| F | 0.060 | 0.075 | 1.52 | 1.91 |
| G | 0.095 | 0.105 | 2.41 | 2.67 |
| H | 0.092 | 0.102 | 2.34 | 2.59 |
| J | 0.018 | 0.024 | 0.46 | 0.61 |
| K | 0.090 | 0.110 | 2.29 | 2.79 |
| S | 0.590 | 0.625 | 14.99 | 15.88 |
| V | 0.035 | 0.045 | 0.89 | 1.14 |
| U | 0.002 | 0.010 | 0.05 | 0.25 |
| W | 0.040 | 0.070 | 1.02 | 1.78 |

Dimensions — TO-218AC (K Package) — Isolated Mounting Tab

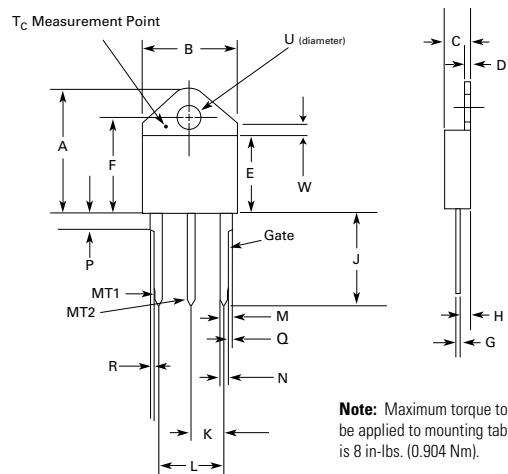

Note: Maximum torque to be applied to mounting tab is 8 in-lbs. (0.904 Nm).

| Dimension | Inches | | Millimeters | |
|-----------|--------|-------|-------------|-------|
| | Min | Max | Min | Max |
| A | 0.810 | 0.835 | 20.57 | 21.21 |
| B | 0.610 | 0.630 | 15.49 | 16.00 |
| C | 0.178 | 0.188 | 4.52 | 4.78 |
| D | 0.055 | 0.070 | 1.40 | 1.78 |
| E | 0.487 | 0.497 | 12.37 | 12.62 |
| F | 0.635 | 0.655 | 16.13 | 16.64 |
| G | 0.022 | 0.029 | 0.56 | 0.74 |
| H | 0.075 | 0.095 | 1.91 | 2.41 |
| J | 0.575 | 0.625 | 14.61 | 15.88 |
| K | 0.211 | 0.219 | 5.36 | 5.56 |
| L | 0.422 | 0.437 | 10.72 | 11.10 |
| M | 0.058 | 0.068 | 1.47 | 1.73 |
| N | 0.045 | 0.055 | 1.14 | 1.40 |
| P | 0.095 | 0.115 | 2.41 | 2.92 |
| Q | 0.008 | 0.016 | 0.20 | 0.41 |
| R | 0.008 | 0.016 | 0.20 | 0.41 |
| U | 0.164 | 0.165 | 4.10 | 4.20 |
| W | 0.085 | 0.095 | 2.17 | 2.42 |

Dimensions — TO-218X (J Package) — Isolated Mounting Tab

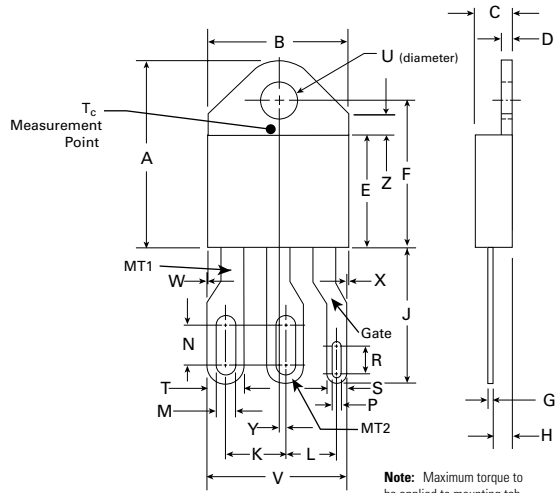

Note: Maximum torque to be applied to mounting tab is 8 in-lbs. (0.904 Nm).

| Dimension | Inches | | Millimeters | |
|-----------|--------|-------|-------------|-------|
| | Min | Max | Min | Max |
| A | 0.810 | 0.835 | 20.57 | 21.21 |
| B | 0.610 | 0.630 | 15.49 | 16.00 |
| C | 0.178 | 0.188 | 4.52 | 4.78 |
| D | 0.055 | 0.070 | 1.40 | 1.78 |
| E | 0.487 | 0.497 | 12.37 | 12.62 |
| F | 0.635 | 0.655 | 16.13 | 16.64 |
| G | 0.022 | 0.029 | 0.56 | 0.74 |
| H | 0.075 | 0.095 | 1.91 | 2.41 |
| J | 0.575 | 0.625 | 14.61 | 15.88 |
| K | 0.256 | 0.264 | 6.50 | 6.71 |
| L | 0.220 | 0.228 | 5.58 | 5.79 |
| M | 0.080 | 0.088 | 2.03 | 2.24 |
| N | 0.169 | 0.177 | 4.29 | 4.49 |
| P | 0.034 | 0.042 | 0.86 | 1.07 |
| R | 0.113 | 0.121 | 2.87 | 3.07 |
| S | 0.086 | 0.096 | 2.18 | 2.44 |
| T | 0.156 | 0.166 | 3.96 | 4.22 |
| U | 0.164 | 0.165 | 0.410 | 0.420 |
| V | 0.603 | 0.618 | 15.31 | 15.70 |
| W | 0.000 | 0.005 | 0.00 | 0.13 |
| X | 0.003 | 0.012 | 0.07 | 0.30 |
| Y | 0.028 | 0.032 | 0.71 | 0.81 |
| Z | 0.085 | 0.095 | 2.17 | 2.42 |

Product Selector

| Part Number | Voltage | | | | Gate Sensitivity Quadrants | | Package |
|-----------------------|---------|------|------|-------|----------------------------|--------------|----------------------------|
| | 400V | 600V | 800V | 1000V | I - II - III | IV | |
| Qxx25R5 | X | X | X | X | 50 mA | 120 mA (TYP) | TO-220R |
| Qxx25N5 | X | X | X | X | 50 mA | 120 mA (TYP) | TO-263 D ² -Pak |
| Qxx25L5 | X | X | X | X | 50 mA | 120 mA (YTP) | TO-220L |
| Qxx25RH5 ¹ | X | X | X | - | 50 mA | - | TO-220R |
| Qxx25LH5 | X | X | X | - | 50 mA | - | TO-220L |
| Qxx25NH5 | X | X | X | - | 50 mA | - | TO-263 D ² -Pak |
| Qxx25R6 | X | X | X | X | 80 mA | - | TO-220R |
| Qxx25L6 | X | X | X | X | 80 mA | - | TO-220L |
| Qxx25NH6 | X | X | X | X | 80 mA | - | TO-263 D ² -Pak |
| Qxx25J6 | X | X | X | - | 80 mA | - | TO-218X |
| Qxx25K6 | X | X | X | X | 80 mA | - | TO-218AC |

Packing Options

| Part Number | Marking | Weight | Packing Mode | Base Quantity |
|-------------|----------|--------|------------------|--------------------|
| Qxx25R5TP | Qxx25R5 | 2.20g | Tube | 1000 (50 per tube) |
| Qxx25N5TP | Qxx25N5 | 1.60g | Tube | 1000 (50 per tube) |
| Qxx25N5RP | Qxx25N5 | 1.60g | Embossed Carrier | 500 |
| Qxx25RH5TP | Qxx25RH5 | 2.20g | Tube | 1000 (50 per tube) |
| Qxx25LH5TP | Qxx25LH5 | 2.20g | Tube | 1000 (50 per tube) |
| Qxx25NH5TP | Qxx25NH5 | 1.60g | Tube | 1000 (50 per tube) |
| Qxx25NH5RP | Qxx25NH5 | 1.60g | Embossed Carrier | 500 |
| Qxx25R6TP | Qxx25R6 | 2.20g | Tube | 1000 (50 per tube) |
| Qxx25L6TP | Qxx25L6 | 2.20g | Tube | 1000 (50 per tube) |
| Qxx25NH6TP | Qxx25NH6 | 1.60g | Tube | 1000 (50 per tube) |
| Qxx25NH6RP | Qxx25NH6 | 1.60g | Embossed Carrier | 500 |
| Qxx25J6TP | Qxx25J6 | 5.23g | Tube | 250 (25 per tube) |
| Qxx25K6TP | Qxx25K6 | 4.40g | Tube | 250 (25 per tube) |
| Qxx25L5TP | Qxx25L5 | 2.20g | Tube | 1000 (50 per tube) |

TO-263 Embossed Carrier Reel Pack (RP) Specifications

Meets all EIA-481-2 Standards

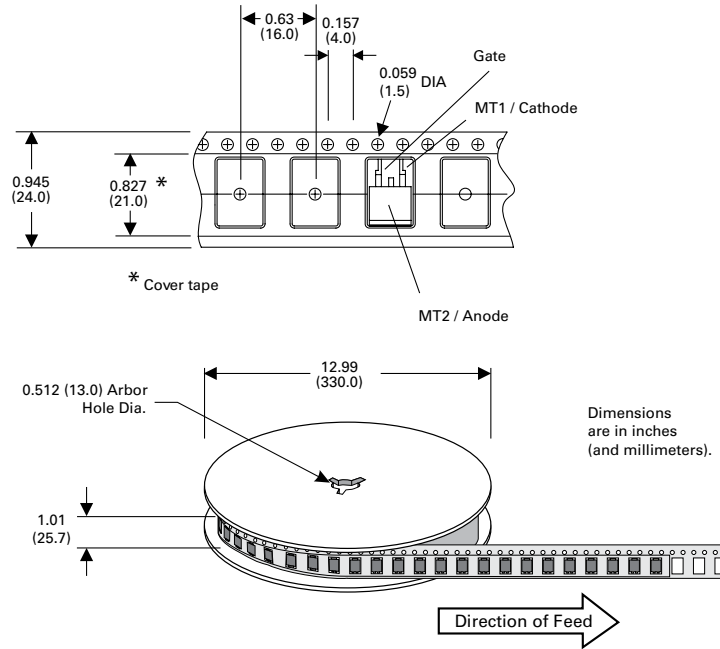

Part Numbering System

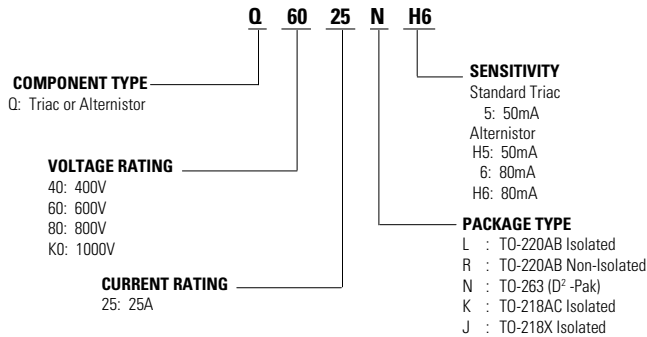

Part Marking System

TO-220 AB - (L and R Package)
TO-263 AB - (N Package)

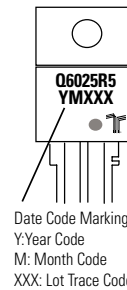

TO-218AC - (K Package)
TO-218X - (J Package)

