

30KPA-HR Series

Axial Leaded – 30 kW

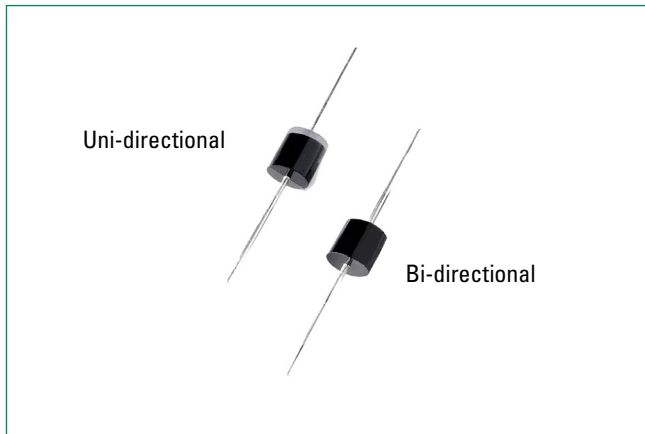

Additional Information



Resources



Accessories



Samples

Agency Approvals

Agency	Agency File Number
	E230531

Maximum Ratings and Thermal Characteristics

($T_A=25^{\circ}\text{C}$ unless otherwise noted)

Parameter	Symbol	Value	Unit
Peak Pulse Power Dissipation by 10/1000 μs Test Waveform (Fig.2)(Note1)	P_{PPM}	30	kW
Steady State Power Dissipation on Infinite Heat Sink at $T_J=75^{\circ}\text{C}$	P_D	8.0	W
Peak Forward Surge Current, 8.3ms Single Half Sine Wave Unidirectional Only (Note 2)	I_{FSM}	400	A
Operating Junction and Storage Temperature Range	T_J, T_{STG}	-55 to 150	$^{\circ}\text{C}$
Typical Thermal Resistance Junction to Lead	$R_{\theta JL}$	8.0	$^{\circ}\text{C}/\text{W}$
Typical Thermal Resistance Junction to Ambient	$R_{\theta JA}$	40	$^{\circ}\text{C}/\text{W}$

Notes:

1. Non-repetitive current pulse per Fig. 4 and derated above T_J (initial) = 25°C per Fig. 3.
2. Measured on 8.3ms single half sine wave or equivalent square wave, duty cycle=4 per minute maximum.

Descriptions

The 30KPA-HR High Reliability Series is designed specifically to protect sensitive electronic equipment from voltage transients induced by lightning and other transient voltage events.

Features & Benefits

- 30kW peak pulse capability at 10/1000 μs waveform, repetition rate (duty cycles):0.01 %
- Glass passivated chip junction in P600 package
- Fast response time: typically less than 1.0ps from 0 Volts to $V_{BR\ min}$
- Excellent clamping capability
- Typical failure mode is short from over-specified voltage or current
- Whisker test is conducted based on JEDEC JESD201A per its table 4a and 4c
- IEC-61000-4-2 ESD 30kV(Air), 30kV (Contact)
- EFT protection of data lines in accordance with IEC 61000-4-4
- Low incremental surge resistance
- Typical I_R less than 2 μA when $V_{BR\ min}>73\text{V}$
- High temperature soldering guaranteed: 260C/10 seconds / 0.375" (9.5mm) lead length, 5 lbs., (2.3kg) tension
- $V_{BR} @ T_J = V_{BR} @ 25^{\circ}\text{C} \times (1 + \alpha T \times (T_J - 25))$ (αT : Temperature Coefficient, typical value is 0.1%)
- UL Recognized compound meeting flammability rating V-0
- Lead-free matte tin plated package
- Halogen free and RoHS compliant
- Pb-free E3 means 2nd level interconnect is Pb-free and the terminal finish material is tin(Sn) (IPC/JEDEC J-STD-609A.01)

Notes: For RTCA/DO-160G testing results, please see tables in the last section of this datasheet

Applications

TVS Components are ideal for the protection of I/O interfaces, V_{CC} bus and other vulnerable circuits used in telecom, computer, industrial and consumer electronic applications.

Functional Diagram

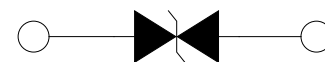

Bi-directional



Uni-directional

30KPA-HR Series

Axial Leaded – 30 kW

Electrical Characteristics ($T_A=25^\circ\text{C}$ unless otherwise noted)

Part Number (Uni)	Part Number (Bi)	Reverse Stand off Voltage V_R (Volts)	Breakdown Voltage V_{BR} (Volts) @ I_T		Test Current I_T (mA)	Maximum Peak Pulse Current I_{PP} (A)	Maximum Reverse Leakage $I_R @ V_R$ (μA)	Maximum Clamping Voltage $V_C @ I_{PP}$ (V)	Agency Recognition 
			MIN	MAX					
30KPA28A-HR	30KPA28CA-HR	28	31.28	34.41	50	606.0	5000	50.0	X
30KPA30A-HR	30KPA30CA-HR	30	33.51	36.86	50	548.9	5000	55.2	X
30KPA33A-HR	30KPA33CA-HR	33	36.90	40.59	50	517.9	5000	58.5	X
30KPA36A-HR	30KPA36CA-HR	36	40.20	44.22	50	490.3	5000	61.8	X
30KPA39A-HR	30KPA39CA-HR	39	43.60	47.96	20	450.9	2000	67.2	X
30KPA42A-HR	30KPA42CA-HR	42	46.90	51.59	10	420.8	1000	72.0	X
30KPA43A-HR	30KPA43CA-HR	43	48.00	52.80	10	415.1	1000	73.0	X
30KPA45A-HR	30KPA45CA-HR	45	50.30	55.33	5	391.5	250	77.4	X
30KPA48A-HR	30KPA48CA-HR	48	53.60	58.96	5	371.3	150	81.6	X
30KPA51A-HR	30KPA51CA-HR	51	57.00	62.70	5	350.7	50	86.4	X
30KPA54A-HR	30KPA54CA-HR	54	60.30	66.33	5	331.5	20	91.4	X
30KPA58A-HR	30KPA58CA-HR	58	64.80	71.28	5	327.9	20	92.4	X
30KPA60A-HR	30KPA60CA-HR	60	67.00	73.70	5	297.1	15	102.0	X
30KPA64A-HR	30KPA64CA-HR	64	71.50	78.65	5	291.3	10	104.0	X
30KPA66A-HR	30KPA66CA-HR	66	73.70	81.07	5	283.2	2	107.0	X
30KPA70A-HR	30KPA70CA-HR	70	78.20	86.02	5	278.0	2	109.0	X
30KPA71A-HR	30KPA71CA-HR	71	79.30	87.23	5	271.7	2	111.5	X
30KPA72A-HR	30KPA72CA-HR	72	80.40	88.44	5	265.8	2	114.0	X
30KPA75A-HR	30KPA75CA-HR	75	83.80	92.18	5	253.8	2	119.4	X
30KPA78A-HR	30KPA78CA-HR	78	87.10	95.81	5	234.9	2	129.0	X
30KPA84A-HR	30KPA84CA-HR	84	93.80	103.18	5	217.7	2	139.2	X
30KPA90A-HR	30KPA90CA-HR	90	100.50	110.55	5	207.0	2	146.4	X
30KPA96A-HR	30KPA96CA-HR	96	107.20	117.92	5	194.2	2	156.0	X
30KPA102A-HR	30KPA102CA-HR	102	113.90	125.29	5	183.0	2	165.6	X
30KPA108A-HR	30KPA108CA-HR	108	120.60	132.66	5	172.9	2	175.2	X
30KPA120A-HR	30KPA120CA-HR	120	134.00	147.40	5	155.9	2	194.4	X
30KPA132A-HR	30KPA132CA-HR	132	147.40	162.14	5	142.3	2	213.0	X
30KPA144A-HR	30KPA144CA-HR	144	160.80	176.88	5	135.8	2	223.2	X
30KPA150A-HR	30KPA150CA-HR	150	167.60	184.36	5	129.8	2	233.4	X
30KPA156A-HR	30KPA156CA-HR	156	174.30	191.73	5	123.7	2	245.0	X
30KPA160A-HR	30KPA160CA-HR	160	178.70	196.57	5	120.0	2	252.6	X
30KPA168A-HR	30KPA168CA-HR	168	187.70	206.47	5	111.2	2	272.4	X
30KPA170A-HR	30KPA170CA-HR	170	189.90	208.89	5	110.2	2	275.0	X
30KPA180A-HR	30KPA180CA-HR	180	201.10	221.21	5	104.3	2	290.4	X
30KPA198A-HR	30KPA198CA-HR	198	221.20	243.32	5	94.7	2	319.8	X
30KPA216A-HR	30KPA216CA-HR	216	241.30	265.43	5	86.9	2	348.6	X
30KPA240A-HR	30KPA240CA-HR	240	268.10	294.91	5	78.3	2	387.0	X
30KPA258A-HR	30KPA258CA-HR	258	288.20	317.02	5	72.8	2	416.4	X
30KPA260A-HR	30KPA260CA-HR	260	290.40	319.44	5	72.8	2	416.0	X
30KPA270A-HR	30KPA270CA-HR	270	301.60	331.76	5	69.5	2	436.2	X
30KPA280A-HR	30KPA280CA-HR	280	312.80	344.08	5	65.3	2	464.0	X
30KPA288A-HR	30KPA288CA-HR	288	321.70	353.87	5	64.5	2	469.9	X
30KPA300A-HR	30KPA300CA-HR	300	334.00	367.40	5	62.0	2	484.0	X
30KPA345A-HR	30KPA345CA-HR	345	384	423	5	54.4	2	557	-

Note: Each lot of parts will pass group B test requirement.

30KPA-HR Series

Axial Leaded – 30 kW

Screen Process

100% Vision Inspection	MIL-STD-750 method 2074
100% High Temperature Storage Life (168hrs,175°C)	MIL-STD-750 method 1031
100% Temperature Cycle Test (-55 to150°C, 20 cycles, dwell time 15 min)	MIL-STD-750 method 1051
100% Surge Test (2x)	MIL-STD-750 method 4066
100% HTRB 150°C Bias=VR(80% breakdown voltage, 96hrs, and each direction 96hrs for Bi-directional products)	MIL-STD-750 method 1038
Final Electrical Test(100% 3 sigma limit, 100% dynamic test and PAT limit)	MIL-STD-750 method 4016.4021.4011

Note: Up-screen program can be specified by customer's request via contacting Littelfuse service

Group B Test Requirement

Screen	Method	Condition	Requirement
Surge test	10/1000 μ s Peak Pulse Waveform	Maximum clamping Voltage (V_C) @ Peak Pulse Current (I_{pp})	Sample Size 45 perform 10x Accept 0 failures
Burn - In (HTRB)	MIL -STD-750, Method 1038.5	Applied voltage 100% V_R @150°C	Sample size 45 340 hours (680 hours for bi-direction products, each direction 340 hours) Accept 0 failures
Electrical test	--	I_R @ V_R , $V_{(BR)}$ @ I_T	Sample size 45 Accept 0 failures

I-V Curve Characteristics

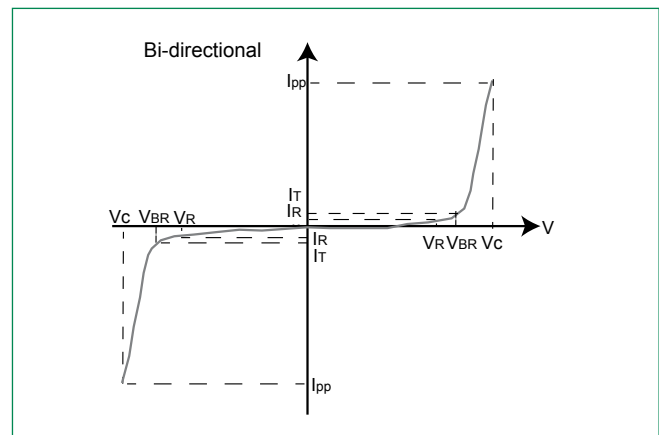
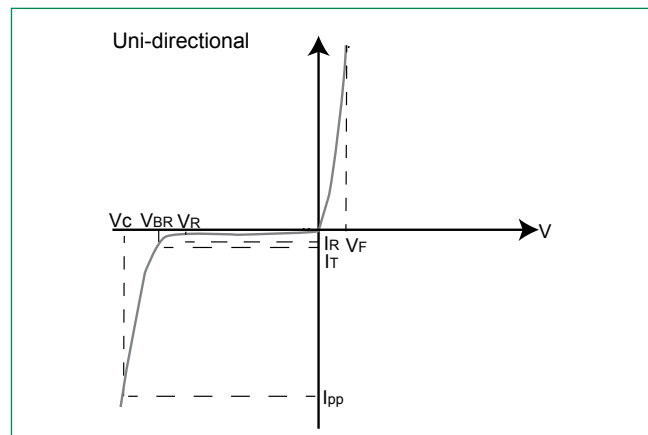

- P_{PPM} Peak Pulse Power Dissipation** – Max power dissipation
 V_R Stand-off Voltage – Maximum voltage that can be applied to the TVS without operation
 V_{BR} Breakdown Voltage – Maximum voltage that flows though the TVS at a specified test current (I_T)
 V_C Clamping Voltage – Peak voltage measured across the TVS at a specified I_{ppm} (peak impulse current)
 I_R Reverse Leakage Current – Current measured at V_R
 V_F Forward Voltage Drop for Uni-directional

30KPA-HR Series

Axial Leaded – 30 kW

Ratings and Characteristic Curves ($T_A=25^\circ\text{C}$ unless otherwise noted)

Figure 1 - TVS Transients Clamping Waveform

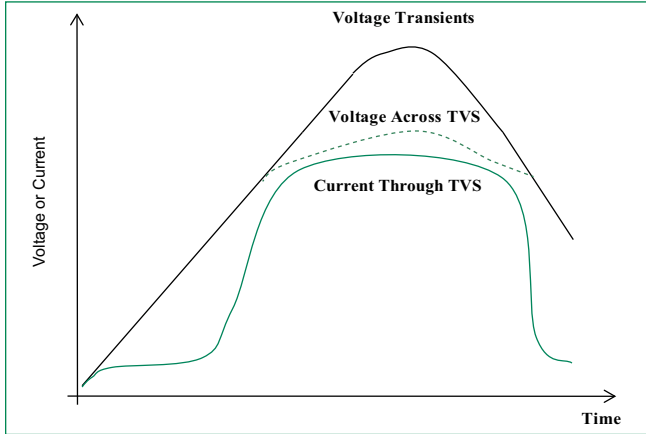

Figure 2 - Peak Pulse Power Rating Curve

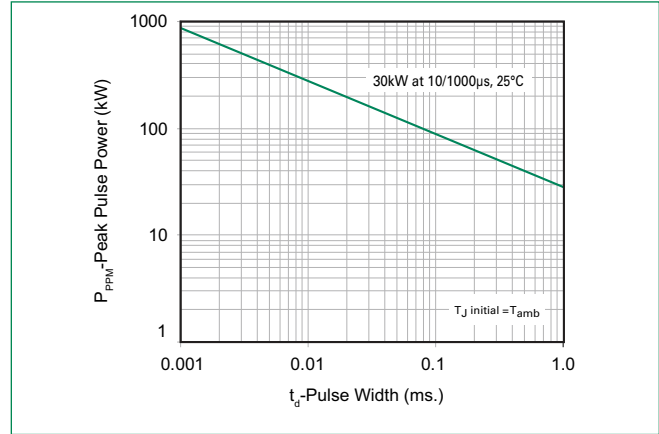

Figure 3 - Peak Pulse Power Derating Curve

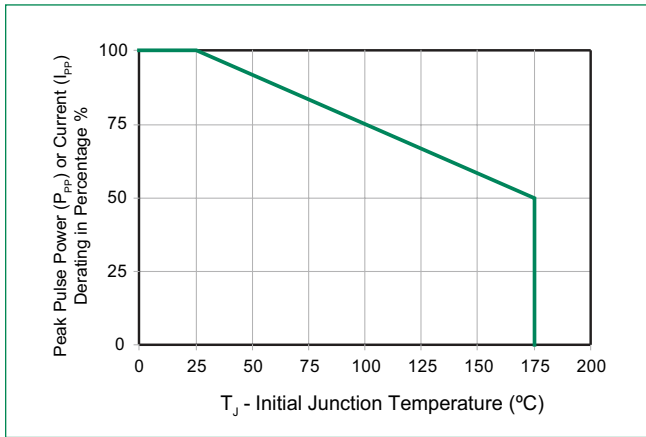

Figure 4 - Pulse Waveform

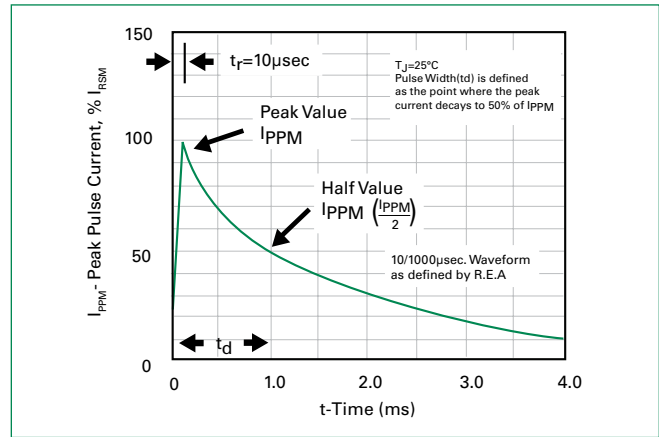

Figure 5 - Typical Junction Capacitance

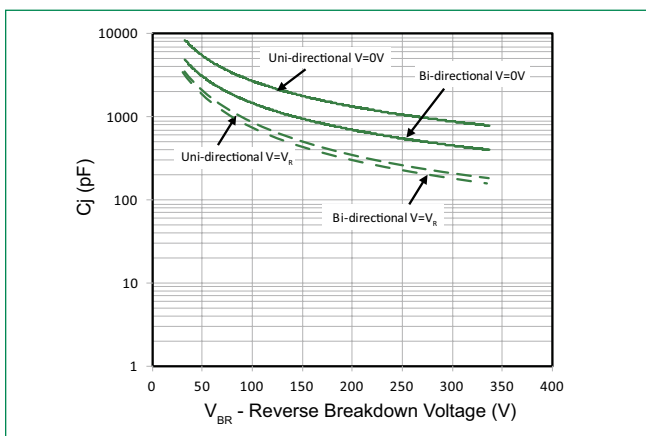
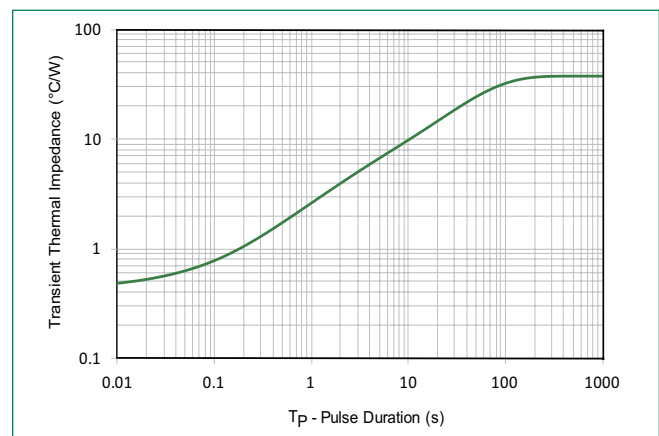

Figure 6 - Typical Transient Thermal Impedance



30KPA-HR Series

Axial Leded – 30 kW

Figure 7 - Maximum Non-Repetitive Peak Forward Surge Current Uni-Directional Only

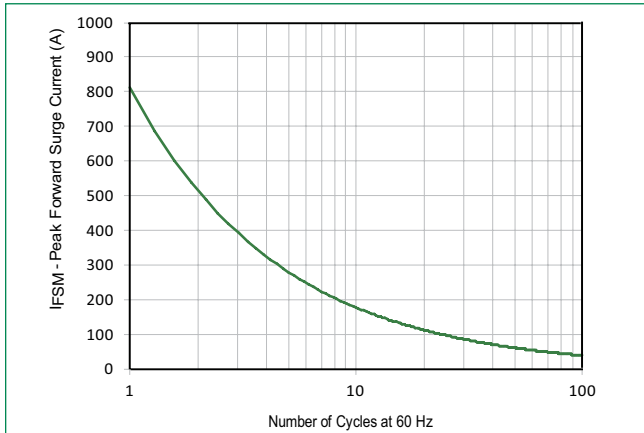
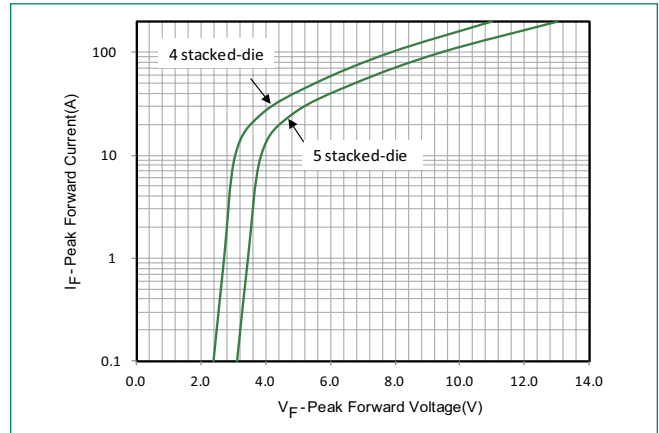

Figure 8 - Peak Forward Voltage Drop vs Peak Forward Current (Typical Values)



Physical Specifications

Weight	0.07oz., 2.5g
Case	P600 molded plastic body over passivated junction.
Polarity	Color band denotes the cathode except Bipolar.
Terminal	Matte Tin axial leads, solderable per JESD22-B102.

Environmental Specifications

High Temp. Storage	JESD22-A103
HTRB	JESD22-A108
Temperature Cycling	JESD22-A104
H3TRB	JESD22-A101
RSH	JESD22-B106

Part Numbering System

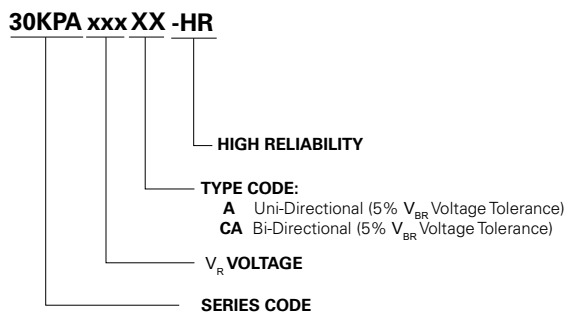

Part Marking System

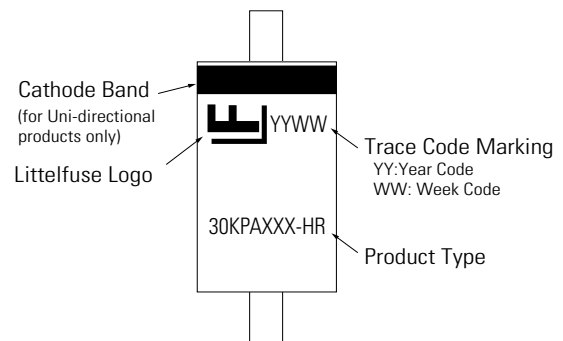

Packing Options

Part Number	Component Package	Quantity	Packaging Option	Packaging Specification
30KPAxxxXX-HR	P600	800	Tape & Reel	EIA STD RS-296

30KPA-HR Series

Axial Leaded – 30 kW

Dimensions

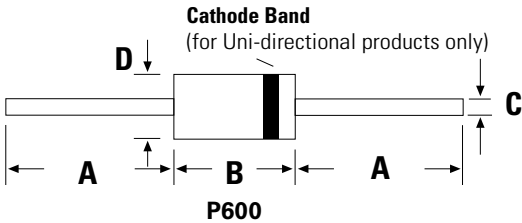

Dimensions	Inches		Millimeters	
	Min	Max	Min	Max
A	1.000	-	25.40	-
B	0.340	0.360	8.60	9.10
C	0.048	0.054	1.22	1.36
D	0.340	0.360	8.60	9.10

Tape and Reel Specification

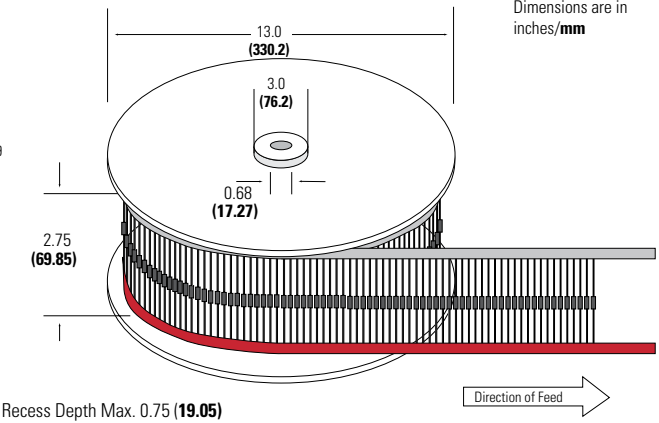
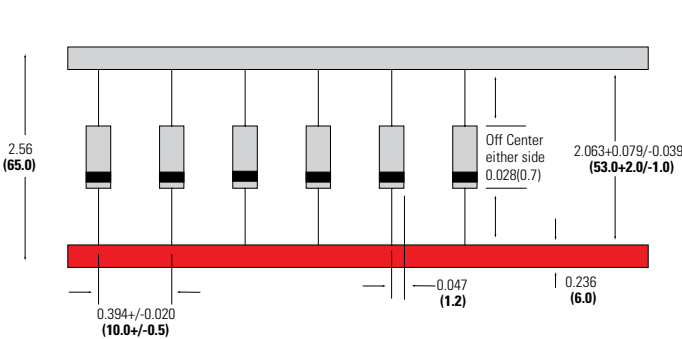

RTCA/DO-160G Wave 4 and Wave 5

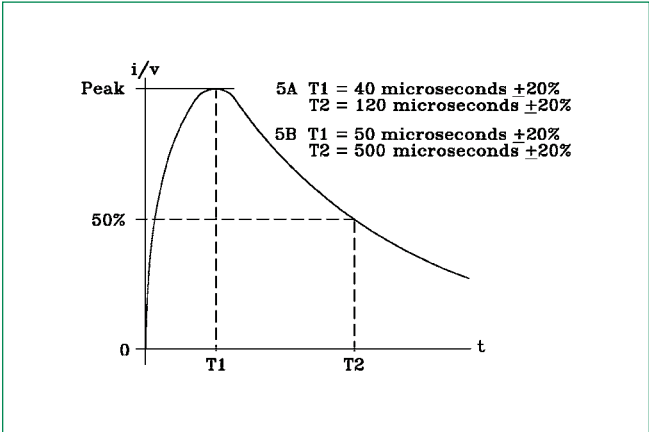
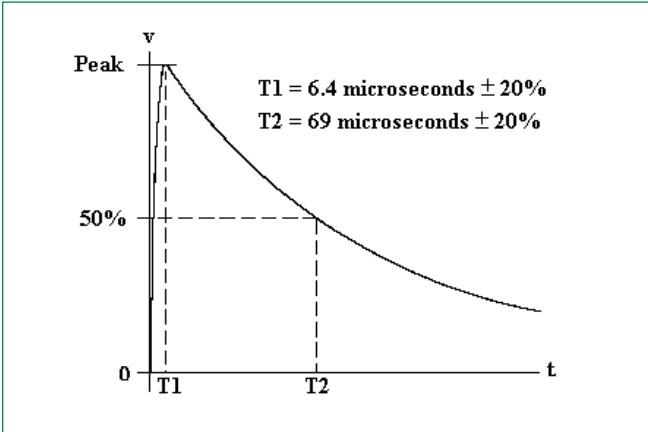

30KPA-HR Series

Axial Leaded – 30 kW

Pin Injection Protection Per RTCA/DO-160G

Part Number (Uni)	Part Number (Bi)	25C						70C						120C					
		Wave 4 (6.4/69us)			Wave 5a (40/120us)			Wave 4 (6.4/69us)			Wave 5a (40/120us)			Wave 4 (6.4/69us)			Wave 5a (40/120us)		
		L3 60A	L4 150A	L5 320A	L3 300A	L4 750A	L5 1600A	L3 60A	L4 150A	L5 320A	L3 300A	L4 750A	L5 1600A	L3 60A	L4 150A	L5 320A	L3 300A	L4 750A	L5 1600A
30KPA28A-HR	30KPA28CA-HR	pass	pass	pass	pass	pass	pass	pass	pass	pass	pass	pass	pass	pass	pass	pass	pass	pass	pass
30KPA30A-HR	30KPA30CA-HR	pass	pass	pass	pass	pass	pass	pass	pass	pass	pass	pass	pass	pass	pass	pass	pass	pass	pass
30KPA33A-HR	30KPA33CA-HR	pass	pass	pass	pass	pass	-	pass	pass	pass	pass	pass	pass	pass	pass	pass	pass	pass	pass
30KPA36A-HR	30KPA36CA-HR	pass	pass	pass	pass	pass	-	pass	pass	pass	pass	pass	pass	pass	pass	pass	pass	pass	pass
30KPA39A-HR	30KPA39CA-HR	pass	pass	pass	pass	pass	-	pass	pass	pass	pass	pass	pass	pass	pass	pass	pass	pass	pass
30KPA42A-HR	30KPA42CA-HR	pass	pass	pass	pass	pass	-	pass	pass	pass	pass	pass	pass	pass	pass	pass	pass	pass	pass
30KPA43A-HR	30KPA43CA-HR	pass	pass	pass	pass	pass	-	pass	pass	pass	pass	pass	pass	pass	pass	pass	pass	pass	pass
30KPA45A-HR	30KPA45CA-HR	pass	pass	pass	pass	pass	-	pass	pass	pass	pass	pass	pass	pass	pass	pass	pass	pass	pass
30KPA48A-HR	30KPA48CA-HR	pass	pass	pass	pass	pass	-	pass	pass	pass	pass	pass	pass	pass	pass	pass	pass	pass	pass
30KPA51A-HR	30KPA51CA-HR	pass	pass	pass	pass	pass	-	pass	pass	pass	pass	pass	pass	pass	pass	pass	pass	pass	pass
30KPA54A-HR	30KPA54CA-HR	pass	pass	pass	pass	pass	-	pass	pass	pass	pass	pass	pass	pass	pass	pass	pass	pass	pass
30KPA58A-HR	30KPA58CA-HR	pass	pass	pass	pass	pass	-	pass	pass	pass	pass	pass	pass	pass	pass	pass	pass	pass	pass
30KPA60A-HR	30KPA60CA-HR	pass	pass	pass	pass	pass	-	pass	pass	pass	pass	pass	pass	pass	pass	pass	pass	pass	pass
30KPA64A-HR	30KPA64CA-HR	pass	pass	pass	pass	pass	-	pass	pass	pass	pass	pass	pass	pass	pass	pass	pass	pass	pass
30KPA66A-HR	30KPA66CA-HR	pass	pass	pass	pass	pass	-	pass	pass	pass	pass	pass	pass	pass	pass	pass	pass	pass	pass
30KPA70A-HR	30KPA70CA-HR	pass	pass	pass	pass	pass	-	pass	pass	pass	pass	pass	pass	pass	pass	pass	pass	pass	pass
30KPA71A-HR	30KPA71CA-HR	pass	pass	pass	pass	pass	-	pass	pass	pass	pass	pass	pass	pass	pass	pass	pass	pass	pass
30KPA72A-HR	30KPA72CA-HR	pass	pass	pass	pass	pass	-	pass	pass	pass	pass	pass	pass	pass	pass	pass	pass	pass	pass
30KPA75A-HR	30KPA75CA-HR	pass	pass	pass	pass	pass	-	pass	pass	pass	pass	pass	pass	pass	pass	pass	pass	pass	pass
30KPA78A-HR	30KPA78CA-HR	pass	pass	pass	pass	pass	-	pass	pass	pass	pass	pass	pass	pass	pass	pass	pass	pass	pass
30KPA84A-HR	30KPA84CA-HR	pass	pass	pass	pass	-	-	pass	pass	pass	pass	-	-	pass	pass	pass	pass	pass	pass
30KPA90A-HR	30KPA90CA-HR	pass	pass	pass	pass	-	-	pass	pass	pass	pass	-	-	pass	pass	pass	pass	pass	pass
30KPA96A-HR	30KPA96CA-HR	pass	pass	pass	pass	-	-	pass	pass	pass	pass	-	-	pass	pass	pass	pass	pass	pass
30KPA102A-HR	30KPA102CA-HR	pass	pass	pass	pass	-	-	pass	pass	pass	pass	-	-	pass	pass	pass	pass	pass	pass
30KPA108A-HR	30KPA108CA-HR	pass	pass	pass	pass	-	-	pass	pass	pass	pass	-	-	pass	pass	pass	pass	pass	pass
30KPA120A-HR	30KPA120CA-HR	pass	pass	pass	pass	-	-	pass	pass	pass	pass	-	-	pass	pass	pass	pass	pass	pass
30KPA132A-HR	30KPA132CA-HR	pass	pass	pass	pass	-	-	pass	pass	pass	pass	-	-	pass	pass	pass	pass	pass	pass
30KPA144A-HR	30KPA144CA-HR	pass	pass	pass	pass	-	-	pass	pass	pass	pass	-	-	pass	pass	pass	pass	pass	pass
30KPA150A-HR	30KPA150CA-HR	pass	pass	pass	pass	-	-	pass	pass	pass	-	-	-	pass	pass	pass	pass	pass	pass
30KPA156A-HR	30KPA156CA-HR	pass	pass	pass	-	-	-	pass	pass	pass	-	-	-	pass	pass	pass	pass	pass	pass
30KPA160A-HR	30KPA160CA-HR	pass	pass	pass	-	-	-	pass	pass	pass	-	-	-	pass	pass	pass	pass	pass	pass
30KPA168A-HR	30KPA168CA-HR	pass	pass	pass	-	-	-	pass	pass	pass	-	-	-	pass	pass	pass	pass	pass	pass
30KPA170A-HR	30KPA170CA-HR	pass	pass	pass	-	-	-	pass	pass	pass	-	-	-	pass	pass	pass	pass	pass	pass
30KPA180A-HR	30KPA180CA-HR	pass	pass	pass	-	-	-	pass	pass	pass	-	-	-	pass	pass	pass	pass	pass	pass
30KPA198A-HR	30KPA198CA-HR	pass	pass	pass	-	-	-	pass	pass	pass	-	-	-	pass	pass	pass	pass	pass	pass
30KPA216A-HR	30KPA216CA-HR	pass	pass	pass	-	-	-	pass	pass	pass	-	-	-	pass	pass	pass	pass	pass	pass
30KPA240A-HR	30KPA240CA-HR	pass	pass	pass	-	-	-	pass	pass	-	-	-	-	pass	pass	pass	pass	pass	pass
30KPA258A-HR	30KPA258CA-HR	pass	pass	pass	-	-	-	pass	pass	-	-	-	-	pass	pass	pass	pass	pass	pass
30KPA260A-HR	30KPA260CA-HR	pass	pass	pass	-	-	-	pass	pass	-	-	-	-	pass	pass	pass	pass	pass	pass
30KPA270A-HR	30KPA270CA-HR	pass	pass	pass	-	-	-	pass	pass	-	-	-	-	pass	pass	pass	pass	pass	pass
30KPA280A-HR	30KPA280CA-HR	pass	pass	pass	-	-	-	pass	pass	-	-	-	-	pass	pass	pass	pass	pass	pass
30KPA288A-HR	30KPA288CA-HR	pass	pass	pass	-	-	-	pass	pass	-	-	-	-	pass	pass	pass	pass	pass	pass
30KPA300A-HR	30KPA300CA-HR	pass	pass	pass	-	-	-	pass	pass	-	-	-	-	pass	pass	pass	pass	pass	pass
30KPA300A-HR	30KPA300CA-HR	pass	pass	pass	-	-	-	pass	pass	-	-	-	-	pass	pass	pass	pass	pass	pass
30KPA345A-HR	30KPA345CA-HR	pass	pass	pass	-	-	-	pass	pass	-	-	-	-	pass	pass	pass	pass	pass	pass

Note: L1 = Level 1, L2 = Level 2, L3 = Level 3, L4 = Level 4, L5 = Level 5

Disclaimer Notice - Information furnished is believed to be accurate and reliable. However, users should independently evaluate the suitability of and test each product selected for their own applications. Littelfuse products are not designed for, and may not be used in, all applications. Read complete Disclaimer Notice at www.littelfuse.com/disclaimer-electronics.