

Polar™ HiperFET™
Power MOSFET

IXFT44N50P
IXFH44N50P
IXFK44N50P

V_{DSS} = 500V
I_{D25} = 44A
R_{DS(on)} ≤ 140mΩ

N-Channel Enhancement Mode
Avalanche Rated
Fast Intrinsic Rectifier



TO-268 (IXFT)

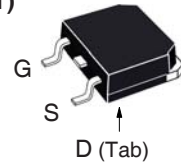

TO-247 (IXFH)

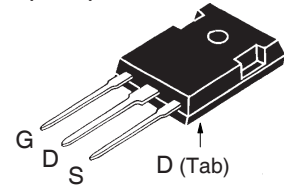

TO-264 (IXFK)

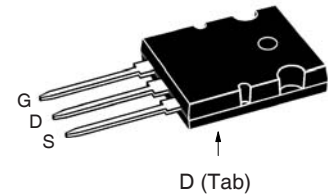

G = Gate D = Drain
S = Source Tab = Drain

Symbol	Test Conditions	Maximum Ratings	
V _{DSS}	T _J = 25°C to 150°C	500	V
V _{DGR}	T _J = 25°C to 150°C, R _{GS} = 1MΩ	500	V
V _{GSS}	Continuous	± 30	V
V _{GSM}	Transient	± 40	V
I _{D25}	T _C = 25°C	44	A
I _{DM}	T _C = 25°C, Pulse Width Limited by T _{JM}	110	A
I _A	T _C = 25°C	44	A
E _{AS}	T _C = 25°C	1.7	J
dv/dt	I _S ≤ I _{DM} , V _{DD} ≤ V _{DSS} , T _J ≤ 150°C	10	V/ns
P _D	T _C = 25°C	658	W
T _J		-55 ... +150	°C
T _{JM}		150	°C
T _{stg}		-55 ... +150	°C
T _L	Maximum Lead Temperature for Soldering	300	°C
T _{SOLD}	Plastic Body for 10s	260	°C
M _d	Mounting Torque (TO-247& TO-264)	1.13/10	Nm/lb.in
Weight	TO-268	4	g
	TO-247	6	g
	TO-264	10	g

Symbol	Test Conditions (T _J = 25°C Unless Otherwise Specified)	Characteristic Values		
		Min.	Typ.	Max.
BV _{DSS}	V _{GS} = 0V, I _D = 250μA	500		V
V _{GS(th)}	V _{DS} = V _{GS} , I _D = 4mA	3.0		5.0 V
I _{GSS}	V _{GS} = ±30V, V _{DS} = 0V			±100 nA
I _{DSS}	V _{DS} = V _{DSS} , V _{GS} = 0V T _J = 125°C			25 μA 500 μA
R _{DS(on)}	V _{GS} = 10V, I _D = 0.5 • I _{D25} , Note 1			140 mΩ

Features

- International Standard Packages
- Fast Intrinsic Rectifier
- Avalanche Rated
- Low R_{DS(ON)} and Q_G
- Low Package Inductance

Advantages

- High Power Density
- Easy to Mount
- Space Savings

Applications

- Switch-Mode and Resonant-Mode Power Supplies
- DC-DC Converters
- Laser Drivers
- AC and DC Motor Drives
- Robotics and Servo Controls

Symbol	Test Conditions	Characteristic Values		
		Min.	Typ.	Max.
g_{fs}	$V_{DS} = 20V, I_D = 0.5 \cdot I_{D25}, \text{ Note 1}$	20	32	S
C_{iss}	$V_{GS} = 0V, V_{DS} = 25V, f = 1MHz$		5440	pF
C_{oss}			639	pF
C_{rss}			40	pF
$t_{d(on)}$	Resistive Switching Times $V_{GS} = 10V, V_{DS} = 0.5 \cdot V_{DSS}, I_D = 0.5 \cdot I_{D25}$ $R_G = 3\Omega \text{ (External)}$		28	ns
t_r			29	ns
$t_{d(off)}$			85	ns
t_f			27	ns
$Q_{g(on)}$	$V_{GS} = 10V, V_{DS} = 0.5 \cdot V_{DSS}, I_D = 0.5 \cdot I_{D25}$		98	nC
Q_{gs}			35	nC
Q_{gd}			30	nC
R_{thJC}	TO-247		0.21	$^{\circ}C/W$
R_{thCS}				$^{\circ}C/W$
R_{thCS}		TO-264	0.15	$^{\circ}C/W$

Source-Drain Diode

Symbol	Test Conditions	Characteristic Values		
		Min.	Typ.	Max.
I_S	$V_{GS} = 0V$			44 A
I_{SM}	Repetitive, Pulse Width Limited by T_{JM}			110 A
V_{SD}	$I_F = I_S, V_{GS} = 0V, \text{ Note 1}$			1.5 V
t_{rr}	$I_F = 25A, -di/dt = 100A/\mu s$ $V_R = 100V, V_{GS} = 0V$			200 ns
I_{RM}			6.0	A
Q_{RM}			0.6	μC

Note 1. Pulse test, $t \leq 300\mu s$, duty cycle, $d \leq 2\%$.

TO-268 Outline

Terminals: 1 - Gate, 2,4 - Drain, 3 - Source

SYM	INCHES		MILLIMETERS	
	MIN	MAX	MIN	MAX
A	.193	.201	4.90	5.10
A1	.106	.114	2.70	2.90
A2	.001	.010	0.02	0.25
b	.045	.057	1.15	1.45
b1	.075	.083	1.90	2.10
b2	.016	.026	0.40	0.65
C	.057	.063	1.45	1.60
C2	.543	.551	13.80	14.00
D	.488	.500	12.40	12.70
D1	.624	.632	15.85	16.05
E	.524	.535	13.30	13.60
e	.215 BSC		5.45 BSC	
H	.736	.752	18.70	19.10
L	.094	.106	2.40	2.70
L1	.047	.055	1.20	1.40
L2	.039	.045	1.00	1.15
L3	.010 BSC		0.25 BSC	
L4	.150	.161	3.80	4.10

TO-247 Outline

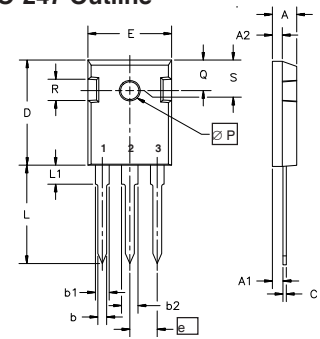

Terminals: 1 - Gate, 2 - Drain, 3 - Source

Dim.	Millimeter		Inches	
	Min.	Max.	Min.	Max.
A	4.7	5.3	.185	.209
A1	2.2	2.54	.087	.102
A2	2.2	2.6	.059	.098
b	1.0	1.4	.040	.055
b1	1.65	2.13	.065	.084
b2	2.87	3.12	.113	.123
C	.4	.8	.016	.031
D	20.80	21.46	.819	.845
E	15.75	16.26	.610	.640
e	5.20	5.72	0.205	0.225
L	19.81	20.32	.780	.800
L1		4.50		.177
∅P	3.55	3.65	.140	.144
Q	5.89	6.40	0.232	0.252
R	4.32	5.49	.170	.216
S	6.15	BSC	242	BSC

TO-264 AA Outline

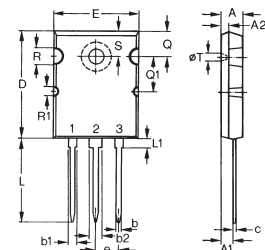

Terminals: 1 - Gate, 2 - Drain, 3 - Source

Dim.	Millimeter		Inches	
	Min.	Max.	Min.	Max.
A	4.82	5.13	.190	.202
A1	2.54	2.89	.100	.114
A2	2.00	2.10	.079	.083
b	1.12	1.42	.044	.056
b1	2.39	2.69	.094	.106
b2	2.90	3.09	.114	.122
c	0.53	0.83	.021	.033
D	25.91	26.16	1.020	1.030
E	19.81	19.96	.780	.786
e	5.46 BSC		.215 BSC	
J	0.00	0.25	.000	.010
K	0.00	0.25	.000	.010
L	20.32	20.83	.800	.820
L1	2.29	2.59	.090	.102
P	3.17	3.66	.125	.144
Q	6.07	6.27	.239	.247
Q1	8.38	8.69	.330	.342
R	3.81	4.32	.150	.170
R1	1.78	2.29	.070	.090
S	6.04	6.30	.238	.248

IXYS Reserves the Right to Change Limits, Test Conditions, and Dimensions.

IXYS MOSFETs and IGBTs are covered by one or more of the following U.S. patents:	4,835,592	4,931,844	5,049,961	5,237,481	6,162,665	6,404,065 B1	6,683,344	6,727,585	7,005,734 B2	7,157,338B2
	4,860,072	5,017,508	5,063,307	5,381,025	6,259,123 B1	6,534,343	6,710,405 B2	6,759,692	7,063,975 B2	
	4,881,106	5,034,796	5,187,117	5,486,715	6,306,728 B1	6,583,505	6,710,463	6,771,478 B2	7,071,537	

Fig. 1. Output Characteristics
@ $T_J = 25^\circ\text{C}$



Fig. 2. Extended Output Characteristics
@ $T_J = 25^\circ\text{C}$

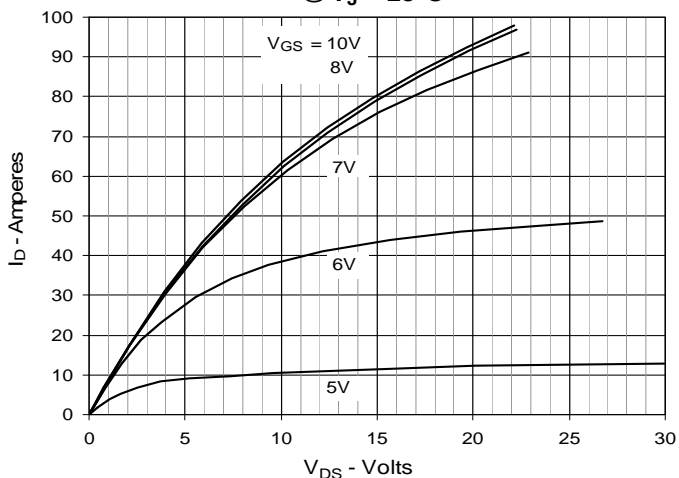

Fig. 3. Output Characteristics
@ $T_J = 125^\circ\text{C}$



Fig. 4. $R_{DS(on)}$ Normalized to $I_D = 22\text{A}$ Value vs. Junction Temperature

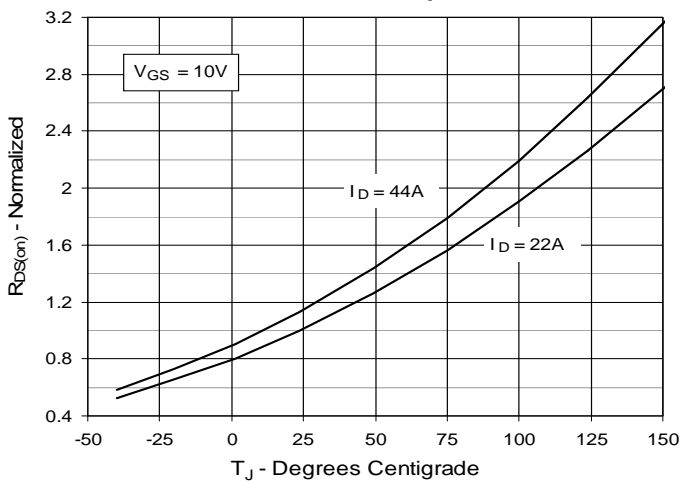

Fig. 5. $R_{DS(on)}$ Normalized to $I_D = 22\text{A}$ Value vs. Drain Current

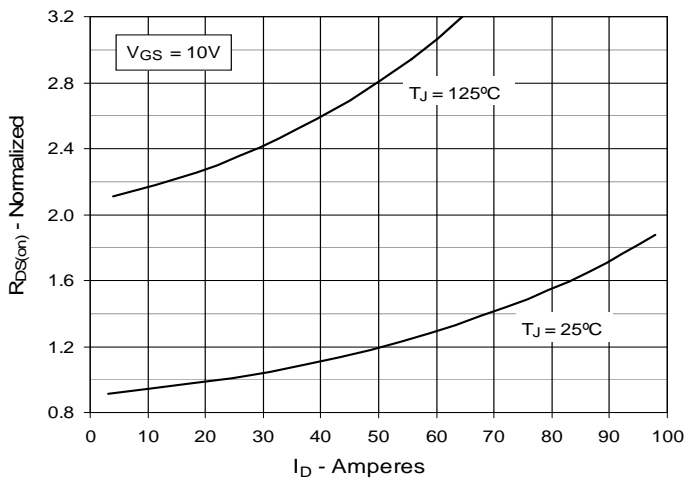

Fig. 6. Maximum Drain Current vs. Case Temperature

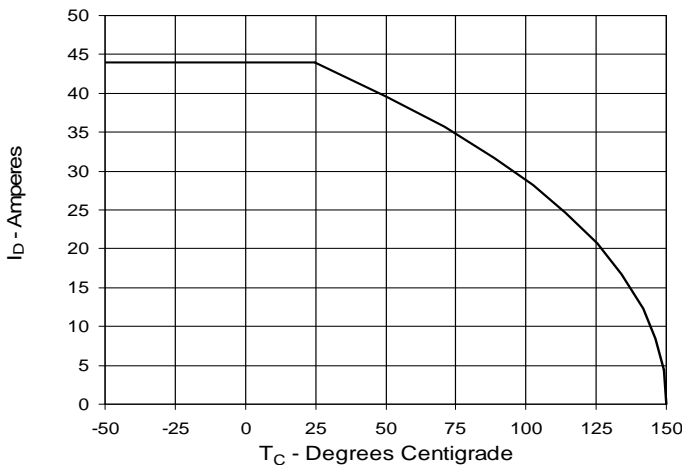

Fig. 7. Input Admittance

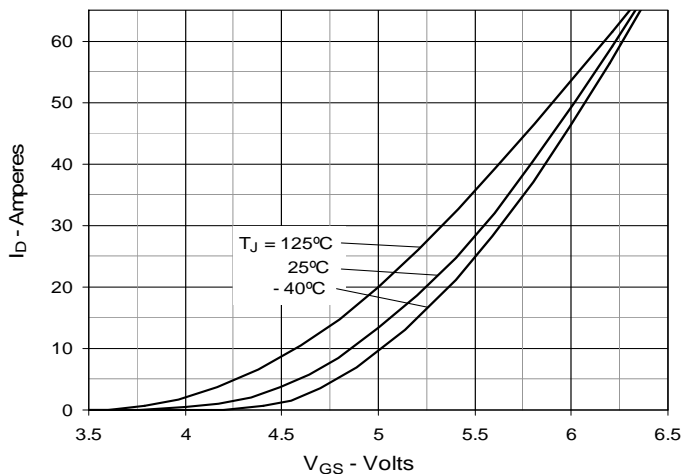

Fig. 8. Transconductance

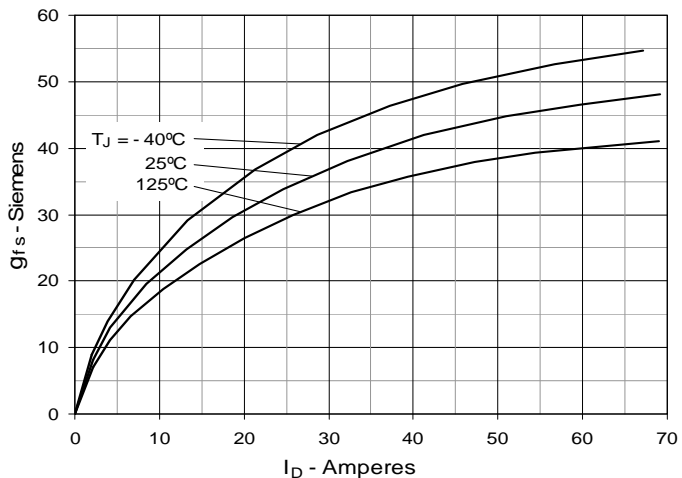

Fig. 9. Forward Voltage Drop of Intrinsic Diode

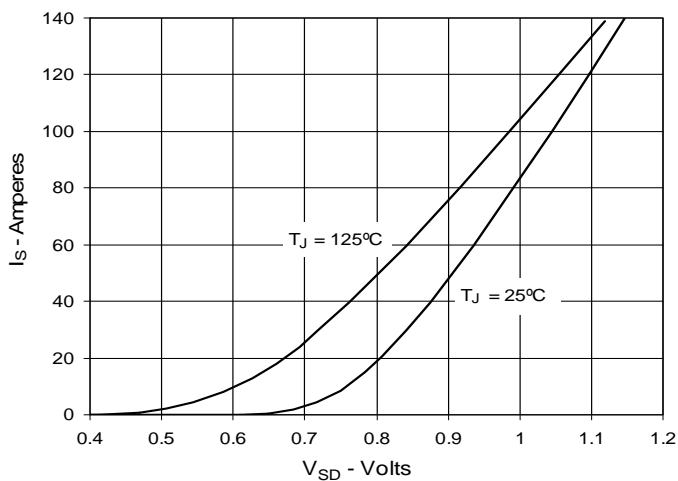

Fig. 10. Gate Charge

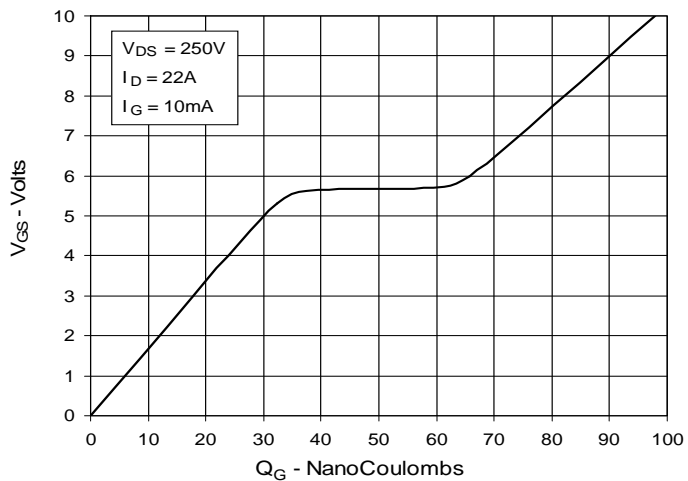

Fig. 11. Capacitance

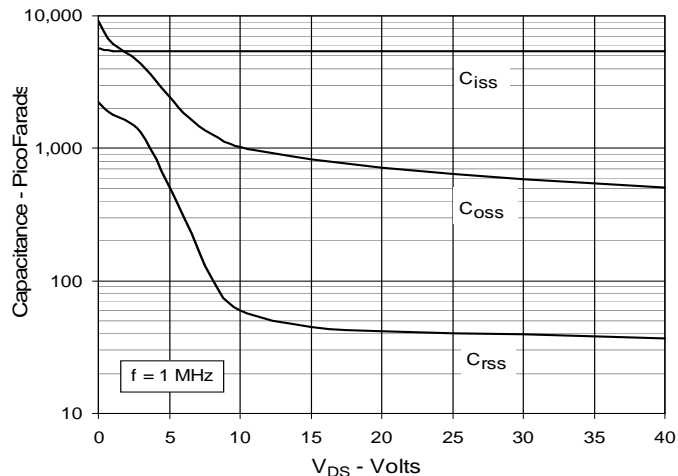

Fig. 12. Forward-Bias Safe Operating Area

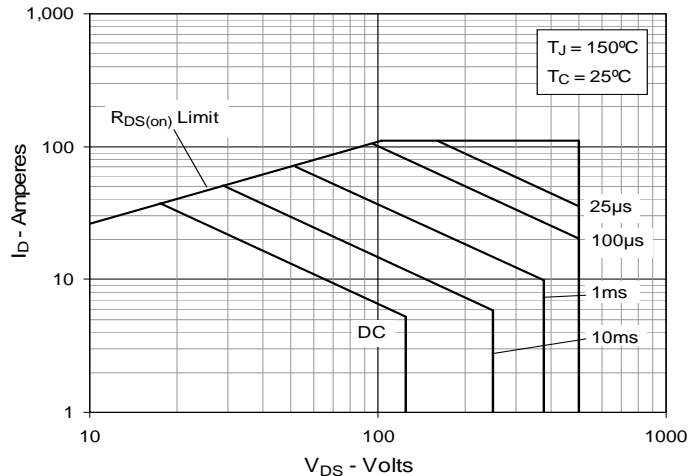
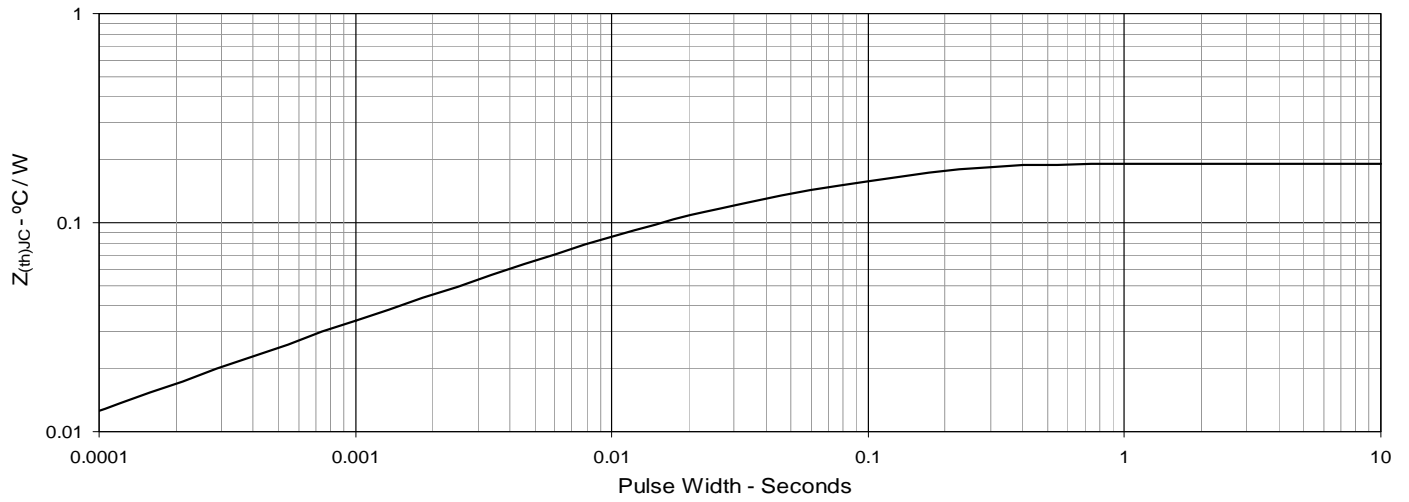

Fig. 13. Maximum Transient Thermal Resistance





Disclaimer Notice - Information furnished is believed to be accurate and reliable. However, users should independently evaluate the suitability of and test each product selected for their own applications. Littelfuse products are not designed for, and may not be used in, all applications. Read complete Disclaimer Notice at www.littelfuse.com/disclaimer-electronics.