

**PLEDxUSxA Series - Unidirectional**

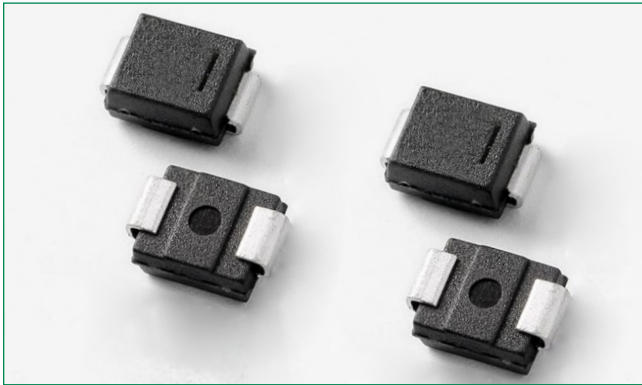

**Description**

PLEDxUSxA open LED protectors provide an electronic switching shunt path when an LED in an LED string fails as an open circuit. This ensures that the remaining string of LEDs will continue to function if a single LED does not.

The components is designed to enable higher reliability in indoor LED lighting applications such as advertisement lighting and other applications.

This series is compatible with one, two and three watt LEDs that have a nominal 3V forward characteristic and is available in an SMB surface mount package. The DO-214AA (SMB) low profile package is ideal for dense board applications.

**Agency Approvals**

Agency	Agency File Number
	E133083

**Schematic Symbol**

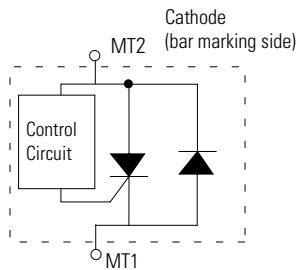

**Features & Benefits**

- Ideal for protecting high brightness LED with high operating current at specified condition.
- Fast switching
- Reverse Battery/Power Protection
- Low profile, small foot print standard DO-214AA package
- Compatible with industrial lighting environments
- IEC 61000-4-2 ESD 30kV (Air), 30kV (Contact)
- ESD protection of data lines in accordance with IEC 61000-4-2 (IEC801-2)
- Compatible with PWM frequencies up to 30 kHz
- RoHS compliant and halogen-free
- Pb-free E3 means 2<sup>nd</sup> level interconnect is Pb-free and the terminal finish material is tin(Sn) (IPC/ JEDEC J-STD-609A.01)
- Recognized to UL 497B as an Isolated Loop Circuit Protector

**Electrical Characteristics** (All parameters are measured at T<sub>A</sub>=25°C unless otherwise noted)

Part Number	Marking	V <sub>BR</sub> breakdown		V <sub>DRM</sub> breakdown	I <sub>H</sub>	I <sub>S</sub>	I <sub>T</sub> @V <sub>T</sub>	V <sub>T</sub> @ I <sub>T</sub> = 1 Amp	I <sub>O</sub> <sup>1</sup>	Critical rate of rise dV/dt
		Volts		Volts	mAmps	mAmps	Amps	Volts	Amps	Volts
		Min	Max	Min	Min	Max	Max	Max	Max	Max
PLED6US2A	PL6U2	6	16	6	5	100	1.0	1.2	2	250V/μs
PLED6US3A	PL6U3	6	16	6	5	100	1.0	1.2	3	250V/μs
PLED9US3A	PL9U3	9	18	9	5	100	1.0	1.2	3	250V/μs

**Notes:**  
1. I<sub>O</sub><sup>1</sup> Operation current tested @ aluminum boards, ambient temp 85°C

### Thermal Considerations

Symbol	Parameter	Value	Unit
$T_J$	Operating Junction Temperature Range	-40 to 150	°C
$T_S$	Storage Temperature Range	-65 to 150	°C
$R_{\theta JA}$	Thermal Resistance: Junction to Ambient	DO-214AA: 90 <sup>1</sup> DO-214AA: 40 <sup>2</sup>	°C/W

**Notes:**

1) Standard FR-4 PCB with Copper Pads (Recommended Size)

2) Aluminum PCB

Thickness: 1.6mm

Grade: 1-2 W/mK Thermal Conductivity

Trace thickness: 2 oz

Insulation layer thickness: 215 um

Solder Pad Dimensions: 2.0mm x 2.8mm (Recommended Size)

### V-I Characteristics

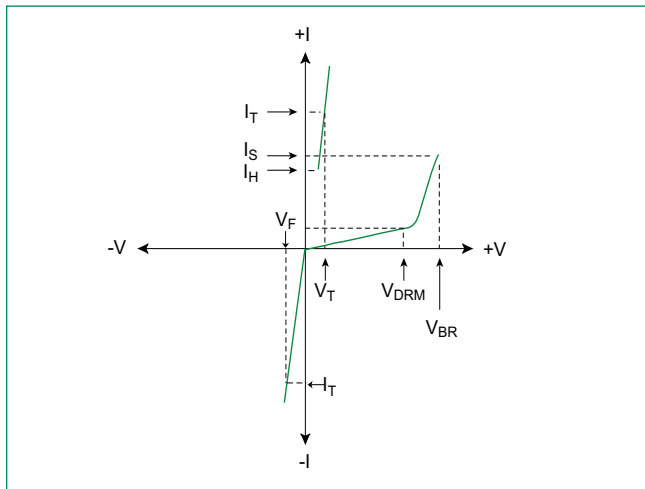

### $V_T$ vs. $I_T$

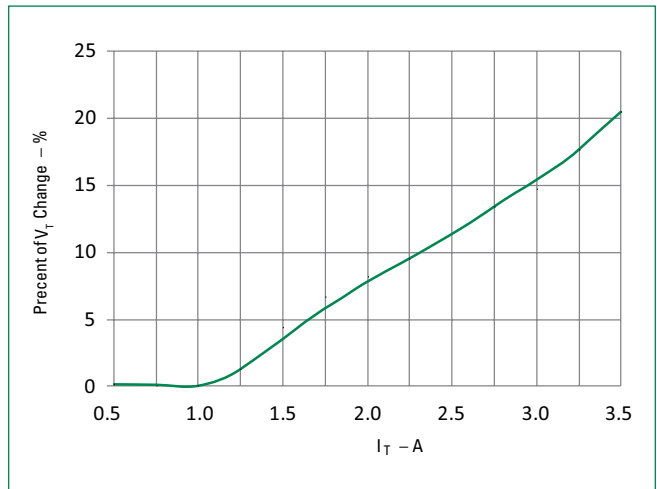

### Normalized DC Holding Current vs. Case Temperature

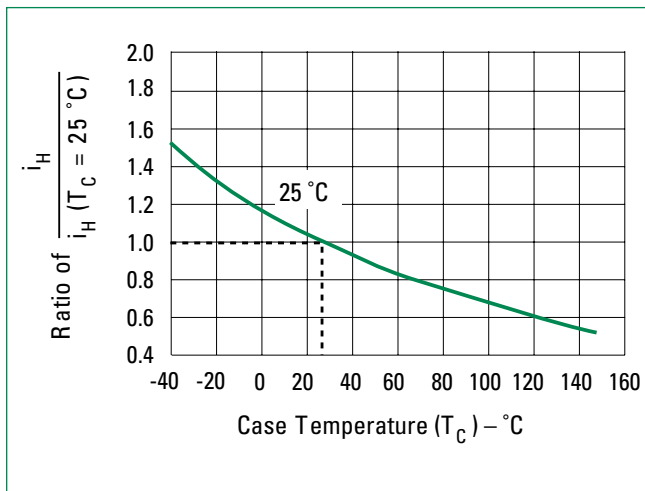

### $V_{BR}$ vs. Junction Temperature

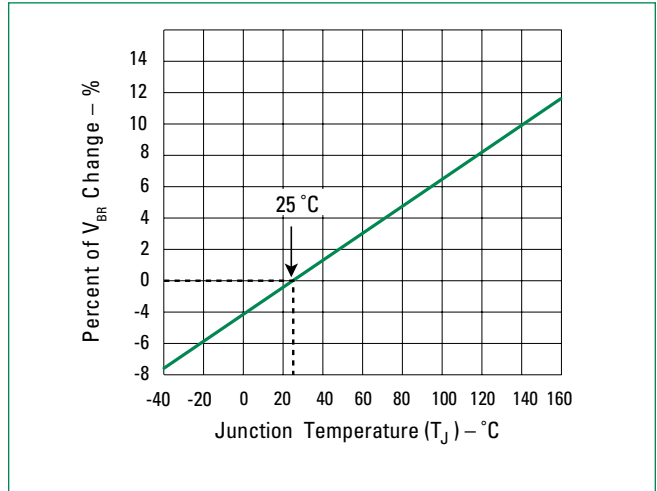

### LED Interference Test Circuit

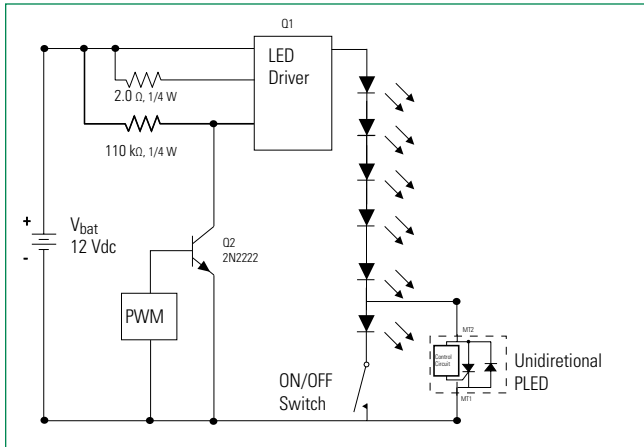

### 6 LEDs in Series 50% Duty Cycle 10kHz

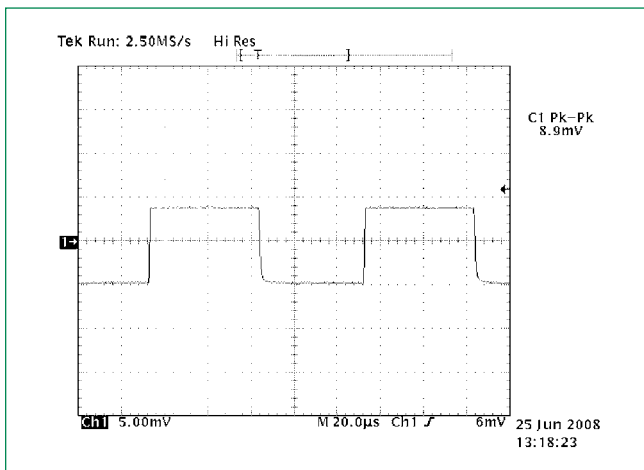

### 5 LEDs and 1 PLED in Series 50% Duty Cycle 10kHz

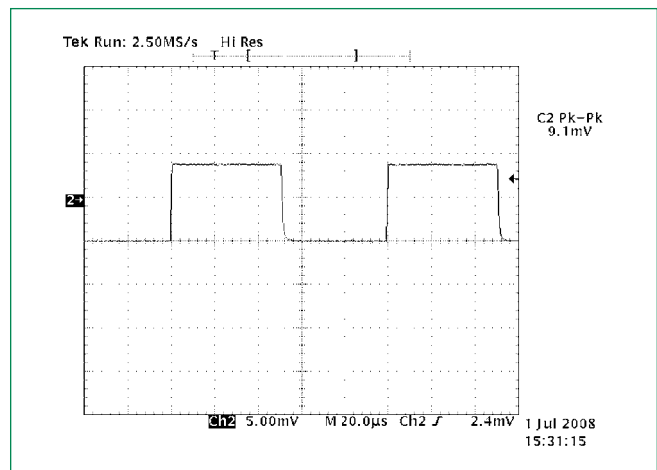

Note: These two graphs show the current magnitude through the LED string with and without the PLED included. There is no noticeable effect on the LED current magnitude when the PLED is included in the circuit as compared to the LED current magnitude when the PLED is not in the circuit. (The conversion factor for the test measurement in the graphs above is 10mA/mV for the Pearson coil measurement, therefore, the current magnitude in the first figure is 10mA\*8.9 = 89mA, while the second figure is 91mA.)

### PLED in the Off-State 10kHz

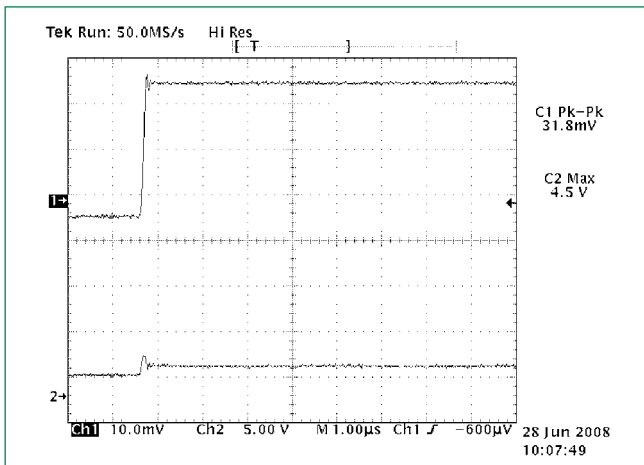

Channel 1: current through LEDs (318 mA)  
Channel 2: voltage across PLED component (4.5 V)

### PLED component zeners and then turns fully on 10kHz

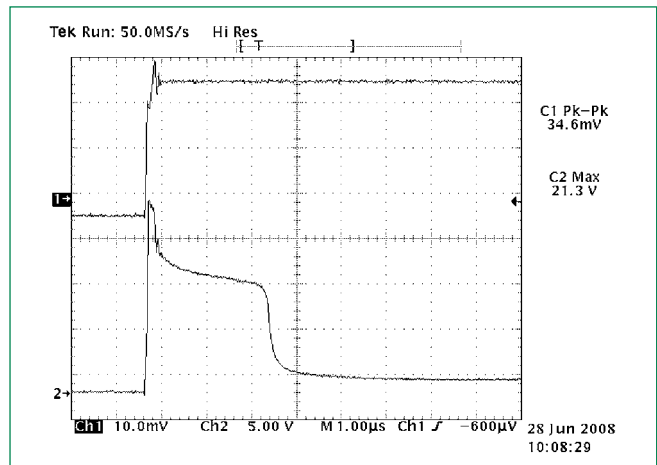

Channel 1: current through LEDs (346 mA) and PLED component once it is fully turned on 2.5 µsec later  
Channel 2: voltage across PLED component (21.3V before PLED crowbars with 2V drop)

### Soldering Parameters

<b>Reflow Condition</b>		Pb – Free assembly
<b>Pre Heat</b>	- Temperature Min ( $T_{s(min)}$ )	150°C
	- Temperature Max ( $T_{s(max)}$ )	200°C
	- Time (min to max) ( $t_v$ )	60 – 180 secs
<b>Average ramp up rate (Liquidus Temp (<math>T_L</math>) to peak)</b>		3°C/second max
<b><math>T_{s(max)}</math> to <math>T_L</math> - Ramp-up Rate</b>		3°C/second max
<b>Reflow</b>	- Temperature ( $T_L$ ) (Liquidus)	217°C
	- Temperature ( $t_L$ )	60 – 150 seconds
<b>Peak Temperature (<math>T_p</math>)</b>		260 <sup>+0/-5</sup> °C
<b>Time within 5°C of actual peak Temperature (<math>t_p</math>)</b>		30 seconds
<b>Ramp-down Rate</b>		6°C/second max
<b>Time 25°C to peak Temperature (<math>T_p</math>)</b>		8 minutes max
<b>Do not exceed</b>		260°C

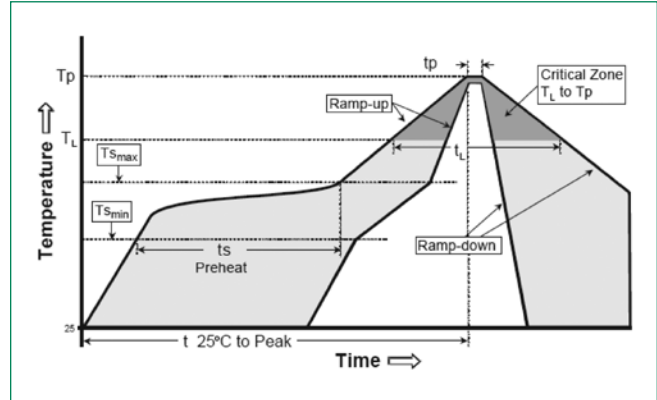

### Physical Specifications

<b>Terminal Material</b>	Copper Alloy
<b>Terminal Finish</b>	100% Matte Tin Plated
<b>Body Material</b>	UL recognized compound meeting flammability classification V-0

### Environmental Specifications

<b>High Temperature Voltage Blocking</b>	MIL-STD-750: Method 1040, Condition A 80% min $V_{DRM}$ (VDC-peak), 150°C, 1008 hours
<b>Temperature Cycling</b>	MIL-STD-750: Method 1051 -55°C to 150°C, 15-minute dwell, 1000 cycles
<b>Biased Temperature &amp; Humidity</b>	EIA/JEDEC: JESD22-A101 80% $V_{DRM}$ , 85°C, 85%RH, 1008 hours
<b>Resistance to Solder Heat</b>	MIL-STD-750: Method 2031 260°C, 10 seconds
<b>Moisture Sensitivity Level</b>	85%RH, +85°C, 168 hrs., 3 reflow cycles (+260°C Peak). JEDEC-J-STD-020, Level 1

### Packaging

Package	Description	Packaging Quantity	Industry Standard
S	DO-214AA	2500	EIA-481-1

### Part Numbering System

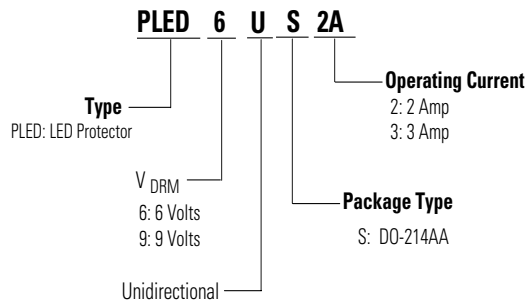

### Part Marking System

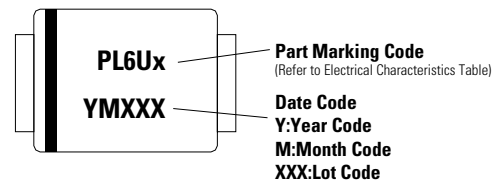

### Dimensions - DO-214 AA Package

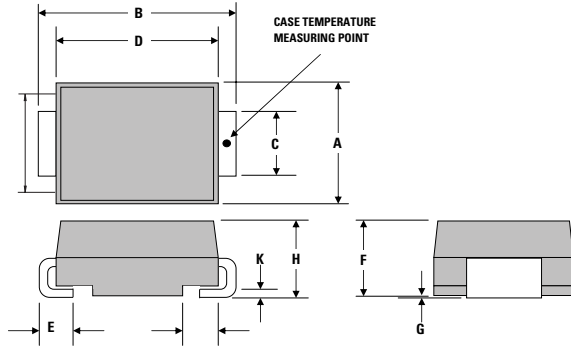

Dimensions	Inches		Millimeters	
	Min	Max	Min	Max
A	0.130	0.156	3.30	3.95
B	0.201	0.220	5.10	5.60
C	0.077	0.087	1.95	2.20
D	0.159	0.181	4.05	4.60
E	0.030	0.063	0.75	1.60
F	0.075	0.096	1.90	2.45
G	0.002	0.008	0.05	0.20
H	0.077	0.104	1.95	2.65
K	0.006	0.016	0.15	0.41

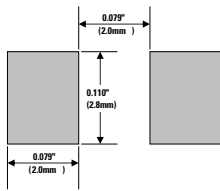

Recommended solder pad layout  
(Reference Only)

### DO-214AA Embossed Carrier Reel Pack (RP)

Meets all EIA-481-1 Standards

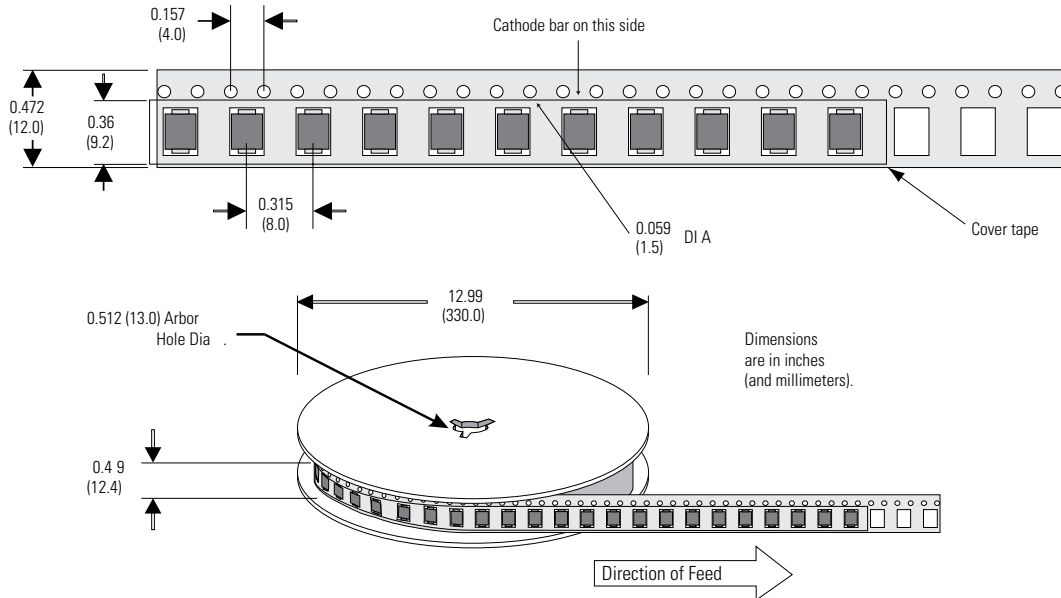

Dimensions  
are in inches  
(and millimeters).