

# High Efficiency Thyristor

$$V_{RRM} = 1200\text{ V}$$

$$I_{TAV} = 30\text{ A}$$

$$V_T = 1.25\text{ V}$$

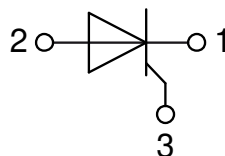
## Single Thyristor

### Part number

**CLA30E1200HB**



Backside: anode



### Features / Advantages:

- Thyristor for line frequency
- Planar passivated chip
- Long-term stability

### Applications:

- Line rectifying 50/60 Hz
- Softstart AC motor control
- DC Motor control
- Power converter
- AC power control
- Lighting and temperature control

### Package: TO-247

- Industry standard outline
- RoHS compliant
- Epoxy meets UL 94V-0

### Disclaimer Notice

Information furnished is believed to be accurate and reliable. However, users should independently evaluate the suitability of and test each product selected for their own applications. Littelfuse products are not designed for, and may not be used in, all applications. Read complete Disclaimer Notice at [www.littelfuse.com/disclaimer-electronics](http://www.littelfuse.com/disclaimer-electronics).

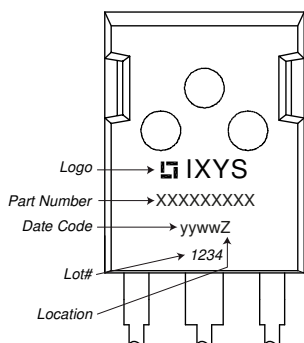


Thyristor			Ratings			
Symbol	Definition	Conditions	min.	typ.	max.	Unit
$V_{RSM/DSM}$	max. non-repetitive reverse/forward blocking voltage	$T_{VJ} = 25^{\circ}C$			1300	V
$V_{RRM/DRM}$	max. repetitive reverse/forward blocking voltage	$T_{VJ} = 25^{\circ}C$			1200	V
$I_{RD}$	reverse current, drain current	$V_{R/D} = 1200\text{ V}$	$T_{VJ} = 25^{\circ}C$		10	$\mu A$
		$V_{R/D} = 1200\text{ V}$	$T_{VJ} = 125^{\circ}C$		2	mA
$V_T$	forward voltage drop	$I_T = 30\text{ A}$	$T_{VJ} = 25^{\circ}C$		1.28	V
		$I_T = 60\text{ A}$			1.56	V
		$I_T = 30\text{ A}$	$T_{VJ} = 125^{\circ}C$		1.25	V
		$I_T = 60\text{ A}$			1.61	V
$I_{TAV}$	average forward current	$T_C = 120^{\circ}C$	$T_{VJ} = 150^{\circ}C$		30	A
$I_{T(RMS)}$	RMS forward current	180° sine			47	A
$V_{T0}$	threshold voltage	} for power loss calculation only	$T_{VJ} = 150^{\circ}C$		0.86	V
$r_T$	slope resistance				12.5	m $\Omega$
$R_{thJC}$	thermal resistance junction to case				0.5	K/W
$R_{thCH}$	thermal resistance case to heatsink			0.3		K/W
$P_{tot}$	total power dissipation		$T_C = 25^{\circ}C$		250	W
$I_{TSM}$	max. forward surge current	$t = 10\text{ ms}; (50\text{ Hz}), \text{ sine}$	$T_{VJ} = 45^{\circ}C$		300	A
		$t = 8,3\text{ ms}; (60\text{ Hz}), \text{ sine}$	$V_R = 0\text{ V}$		325	A
		$t = 10\text{ ms}; (50\text{ Hz}), \text{ sine}$	$T_{VJ} = 150^{\circ}C$		255	A
		$t = 8,3\text{ ms}; (60\text{ Hz}), \text{ sine}$	$V_R = 0\text{ V}$		275	A
$I^2t$	value for fusing	$t = 10\text{ ms}; (50\text{ Hz}), \text{ sine}$	$T_{VJ} = 45^{\circ}C$		450	A <sup>2</sup> s
		$t = 8,3\text{ ms}; (60\text{ Hz}), \text{ sine}$	$V_R = 0\text{ V}$		440	A <sup>2</sup> s
		$t = 10\text{ ms}; (50\text{ Hz}), \text{ sine}$	$T_{VJ} = 150^{\circ}C$		325	A <sup>2</sup> s
		$t = 8,3\text{ ms}; (60\text{ Hz}), \text{ sine}$	$V_R = 0\text{ V}$		315	A <sup>2</sup> s
$C_J$	junction capacitance	$V_R = 400\text{ V } f = 1\text{ MHz}$	$T_{VJ} = 25^{\circ}C$		13	pF
$P_{GM}$	max. gate power dissipation	$t_p = 30\text{ }\mu s$	$T_C = 150^{\circ}C$		10	W
		$t_p = 300\text{ }\mu s$			5	W
$P_{GAV}$	average gate power dissipation				0.5	W
$(di/dt)_{cr}$	critical rate of rise of current	$T_{VJ} = 150^{\circ}C; f = 50\text{ Hz}$	repetitive, $I_T = 90\text{ A}$		150	A/ $\mu s$
		$t_p = 200\text{ }\mu s; di_G/dt = 0.3\text{ A}/\mu s;$	non-repet., $I_T = 30\text{ A}$		500	A/ $\mu s$
$(dv/dt)_{cr}$	critical rate of rise of voltage	$V = \frac{2}{3} V_{DRM}$	$T_{VJ} = 150^{\circ}C$		500	V/ $\mu s$
		$R_{GK} = \infty; \text{ method 1 (linear voltage rise)}$				
$V_{GT}$	gate trigger voltage	$V_D = 6\text{ V}$	$T_{VJ} = 25^{\circ}C$		1.3	V
			$T_{VJ} = -40^{\circ}C$		1.6	V
$I_{GT}$	gate trigger current	$V_D = 6\text{ V}$	$T_{VJ} = 25^{\circ}C$		28	mA
			$T_{VJ} = -40^{\circ}C$		50	mA
$V_{GD}$	gate non-trigger voltage	$V_D = \frac{2}{3} V_{DRM}$	$T_{VJ} = 150^{\circ}C$		0.2	V
$I_{GD}$	gate non-trigger current				1	mA
$I_L$	latching current	$t_p = 10\text{ }\mu s$	$T_{VJ} = 25^{\circ}C$		90	mA
		$I_G = 0.3\text{ A}; di_G/dt = 0.3\text{ A}/\mu s$				
$I_H$	holding current	$V_D = 6\text{ V } R_{GK} = \infty$	$T_{VJ} = 25^{\circ}C$		60	mA
$t_{gd}$	gate controlled delay time	$V_D = \frac{1}{2} V_{DRM}$	$T_{VJ} = 25^{\circ}C$		2	$\mu s$
		$I_G = 0.3\text{ A}; di_G/dt = 0.3\text{ A}/\mu s$				
$t_q$	turn-off time	$V_R = 100\text{ V}; I_T = 30\text{ A}; V = \frac{2}{3} V_{DRM}$	$T_{VJ} = 125^{\circ}C$		150	$\mu s$
		$di/dt = 10\text{ A}/\mu s \text{ } dv/dt = 20\text{ V}/\mu s \text{ } t_p = 200\text{ }\mu s$				



Package TO-247			Ratings			
Symbol	Definition	Conditions	min.	typ.	max.	Unit
$I_{RMS}$	RMS current	per terminal			50	A
$T_{VJ}$	virtual junction temperature		-40		150	°C
$T_{op}$	operation temperature		-40		125	°C
$T_{stg}$	storage temperature		-40		150	°C
<b>Weight</b>				6		g
$M_D$	mounting torque		0.8		1.2	Nm
$F_C$	mounting force with clip		20		120	N

**Product Marking**



**Part description**

- C = Thyristor (SCR)
- L = High Efficiency Thyristor
- A = (up to 1200V)
- 30 = Current Rating [A]
- E = Single Thyristor
- 1200 = Reverse Voltage [V]
- HB = TO-247AD (3)

Ordering	Ordering Number	Marking on Product	Delivery Mode	Quantity	Code No.
Standard	CLA30E1200HB	CLA30E1200HB	Tube	30	508221

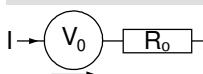
Similar Part	Package	Voltage class
CLA30E1200PB	TO-220AB (3)	1200
CLA30E1200PC	TO-263AB (D2Pak) (2)	1200
CS22-12io1M	TO-220ABFP (3)	1200
CS22-08io1M	TO-220ABFP (3)	800

CMA30E1600PN	TO-220ABFP (3)	1600
CMA30E1600PB	TO-220AB (3)	1600

**Equivalent Circuits for Simulation**

\* on die level

$T_{VJ} = 150^{\circ}C$



**Thyristor**

$V_{0\ max}$	threshold voltage	0.86	V
$R_{0\ max}$	slope resistance *	10	mΩ



**Outlines TO-247**



Sym.	Inches		Millimeter	
	min.	max.	min.	max.
A	0.185	0.209	4.70	5.30
A1	0.087	0.102	2.21	2.59
A2	0.059	0.098	1.50	2.49
D	0.819	0.845	20.79	21.45
E	0.610	0.640	15.48	16.24
E2	0.170	0.216	4.31	5.48
e	0.215 BSC		5.46 BSC	
L	0.780	0.800	19.80	20.30
L1	-	0.177	-	4.49
Ø P	0.140	0.144	3.55	3.65
Q	0.212	0.244	5.38	6.19
S	0.242 BSC		6.14 BSC	
b	0.039	0.055	0.99	1.40
b2	0.065	0.094	1.65	2.39
b4	0.102	0.135	2.59	3.43
c	0.015	0.035	0.38	0.89
D1	0.515	-	13.07	-
D2	0.020	0.053	0.51	1.35
E1	0.530	-	13.45	-
Ø P1	-	0.29	-	7.39



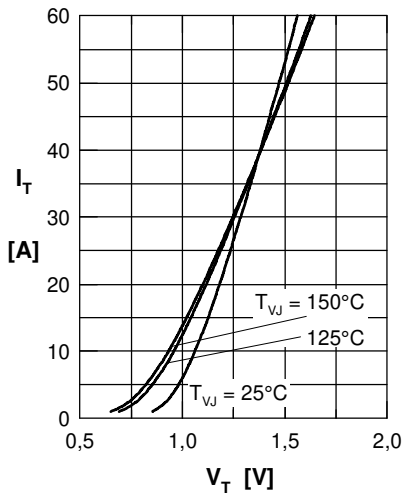
**Thyristor**


Fig. 1 Forward characteristics

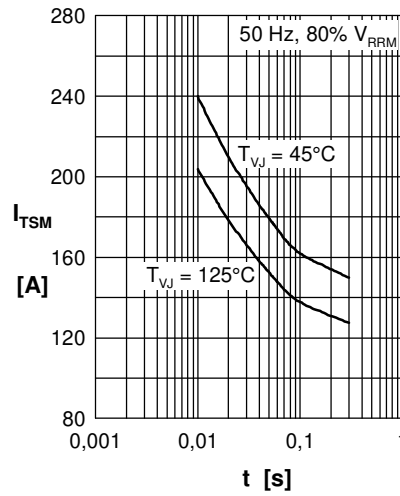
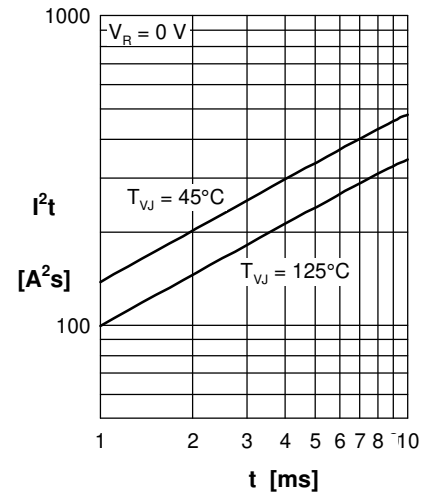

 Fig. 2 Surge overload current  
 $I_{TSM}$ : crest value,  $t$ : duration

 Fig. 3  $I^2t$  versus time (1-10 s)

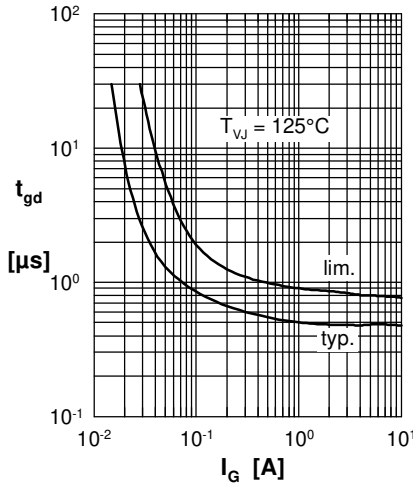
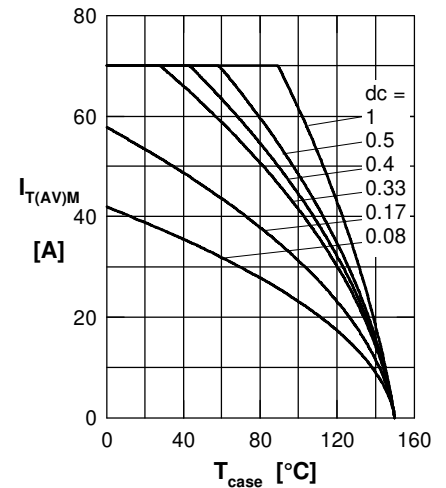
 Fig. 4 Gate voltage & gate current  
 Triggering: A = no; B = possible; C = safe

 Fig. 5 Gate controlled delay time  $t_{gd}$ 


Fig. 6 Max. forward current at case temperature

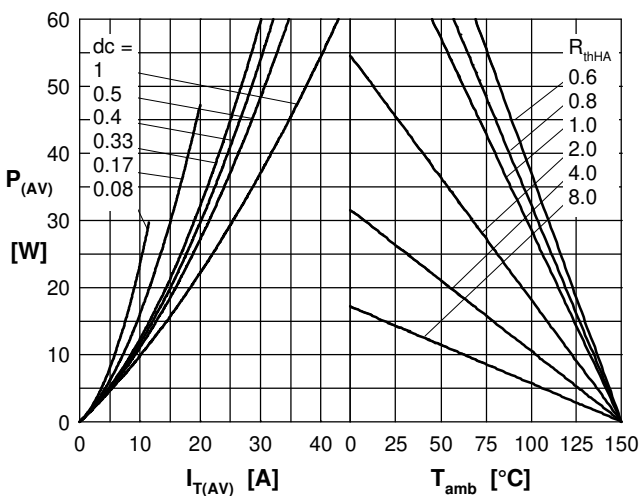
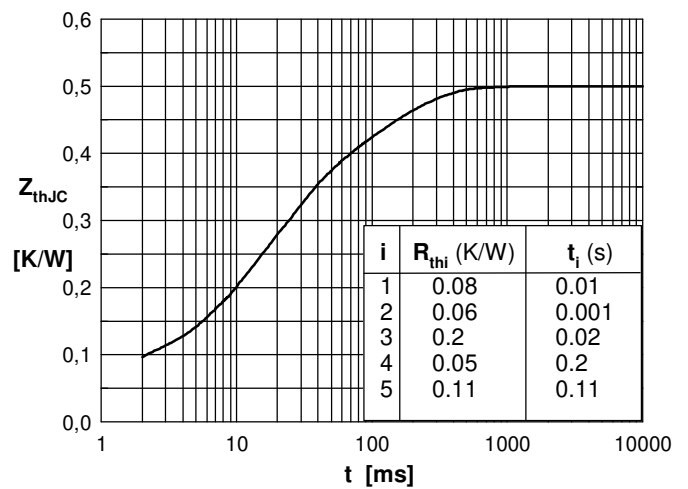

 Fig. 7a Power dissipation versus direct output current  
 Fig. 7b and ambient temperature


Fig. 7 Transient thermal impedance junction to case

