

Polar™ HiPerFET™ Power MOSFET

IXFB300N10P

N-Channel Enhancement Mode
Avalanche Rated
Fast Intrinsic Diode

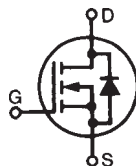

$$V_{DSS} = 100V$$

$$I_{D25} = 300A$$

$$R_{DS(on)} \leq 5.5m\Omega$$

$$t_{rr} \leq 200ns$$

Symbol	Test Conditions	Maximum Ratings	
V_{DSS}	$T_J = 25^\circ C$ to $175^\circ C$	100	V
V_{DGR}	$T_J = 25^\circ C$ to $175^\circ C$, $R_{GS} = 1M\Omega$	100	V
V_{GSS}	Continuous	± 20	V
V_{GSM}	Transient	± 30	V
I_{D25}	$T_C = 25^\circ C$	300	A
I_{LRMS}	Leads Current Limit, RMS	160	A
I_{DM}	$T_C = 25^\circ C$, Pulse Width Limited by T_{JM}	900	A
I_A	$T_C = 25^\circ C$	100	A
E_{AS}	$T_C = 25^\circ C$	3	J
dv/dt	$I_S \leq I_{DM}$, $V_{DD} \leq V_{DSS}$, $T_J \leq 175^\circ C$	20	V/ns
P_D	$T_C = 25^\circ C$	1500	W
T_J		-55 ... +175	$^\circ C$
T_{JM}		175	$^\circ C$
T_{stg}		-55 ... +175	$^\circ C$
T_L	Maximum Lead Temperature for Soldering	300	$^\circ C$
T_{SOLD}	1.6 mm (0.062in.) from Case for 10s	260	$^\circ C$
F_C	Mounting Force	30..120/6.7..27	N/lb
Weight		10	g

PLUS264™

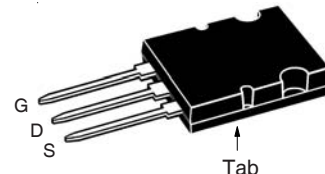

G = Gate D = Drain
S = Source Tab = Drain

Features

- Low $R_{DS(on)}$ and Q_G
- Avalanche Rated
- Low Package Inductance
- Fast Intrinsic Diode

Advantages

- High Power Density
- Easy to Mount
- Space Savings

Applications

- DC-DC Converters
- Battery Chargers
- Switch-Mode and Resonant-Mode Power Supplies
- DC Choppers
- AC and DC Motor Drives
- Uninterrupted Power Supplies
- High Speed Power Switching Applications

Symbol	Test Conditions ($T_J = 25^\circ C$, Unless Otherwise Specified)	Characteristic Values		
		Min.	Typ.	Max.
BV_{DSS}	$V_{GS} = 0V$, $I_D = 3mA$	100		V
$V_{GS(th)}$	$V_{DS} = V_{GS}$, $I_D = 8mA$	2.5		5.0 V
I_{GSS}	$V_{GS} = \pm 20V$, $V_{DS} = 0V$			± 200 nA
I_{DSS}	$V_{DS} = V_{DSS}$, $V_{GS} = 0V$ $T_J = 150^\circ C$			25 μA 1.5 mA
$R_{DS(on)}$	$V_{GS} = 10V$, $I_D = 50A$, Note 1			5.5 m Ω

Symbol	Test Conditions ($T_J = 25^\circ\text{C}$, Unless Otherwise Specified)	Characteristic Values		
		Min.	Typ.	Max.
g_{fs}	$V_{DS} = 10\text{V}, I_D = 60\text{A}$, Note 1	55	92	S
C_{iss}	$V_{GS} = 0\text{V}, V_{DS} = 25\text{V}, f = 1\text{MHz}$		23	nF
C_{oss}			6100	pF
C_{rss}			417	pF
$t_{d(on)}$	Resistive Switching Times $V_{GS} = 10\text{V}, V_{DS} = 0.5 \cdot V_{DSS}, I_D = 100\text{A}$ $R_G = 1\Omega$ (External)		36	ns
t_r			35	ns
$t_{d(off)}$			56	ns
t_f			25	ns
$Q_{g(on)}$	$V_{GS} = 10\text{V}, V_{DS} = 0.5 \cdot V_{DSS}, I_D = 0.5 \cdot I_{D25}$		279	nC
Q_{gs}			84	nC
Q_{gd}			107	nC
R_{thJC}			0.10	$^\circ\text{C/W}$
R_{thCS}		0.13		$^\circ\text{C/W}$

Source-Drain Diode

Symbol	Test Conditions ($T_J = 25^\circ\text{C}$, Unless Otherwise Specified)	Characteristic Values		
		Min.	Typ.	Max.
I_S	$V_{GS} = 0\text{V}$			300 A
I_{SM}	Repetitive, Pulse Width Limited by T_{JM}			1000 A
V_{SD}	$I_F = 100\text{A}, V_{GS} = 0\text{V}$, Note 1			1.3 V
t_{rr}	$I_F = 150\text{A}, -di/dt = 100\text{A}/\mu\text{s}$ $V_R = 50\text{V}$		0.71	200 ns
Q_{RM}				μC
I_{RM}			10	A

Note 1: Pulse test, $t \leq 300\mu\text{s}$, duty cycle, $d \leq 2\%$.

PLUS264™ (IXFB) Outline

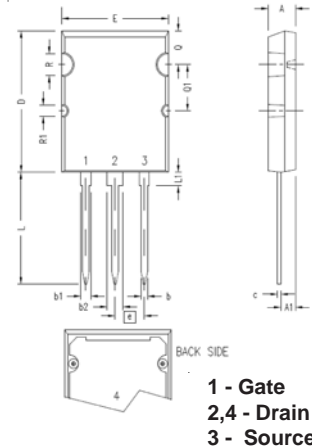

SYM	INCHES		MILLIMETERS	
	MIN	MAX	MIN	MAX
A	.185	.209	4.70	5.31
A1	.102	.118	2.59	3.00
b	.037	.055	0.94	1.40
b1	.087	.102	2.21	2.59
b2	.110	.126	2.79	3.20
c	.017	.029	0.43	0.74
D	1.007	1.047	25.58	26.59
E	.760	.799	19.30	20.29
e	.215 BSC		5.46 BSC	
L	.779	.842	19.79	21.39
L1	.087	.102	2.21	2.59
Q	.240	.256	6.10	6.50
Q1	.330	.346	8.38	8.79
ØR	.155	.187	3.94	4.75
ØR1	.085	.093	2.16	2.36

IXYS Reserves the Right to Change Limits, Test Conditions, and Dimensions.

IXYS MOSFETs and IGBTs are covered by one or more of the following U.S. patents:

4,835,592	4,931,844	5,049,961	5,237,481	6,162,665	6,404,065 B1	6,683,344	6,727,585	7,005,734 B2	7,157,338B2
4,860,072	5,017,508	5,063,307	5,381,025	6,259,123 B1	6,534,343	6,710,405 B2	6,759,692	7,063,975 B2	
4,881,106	5,034,796	5,187,117	5,486,715	6,306,728 B1	6,583,505	6,710,463	6,771,478 B2	7,071,537	

Fig. 1. Extended Output Characteristics @ $T_J = 25^\circ\text{C}$

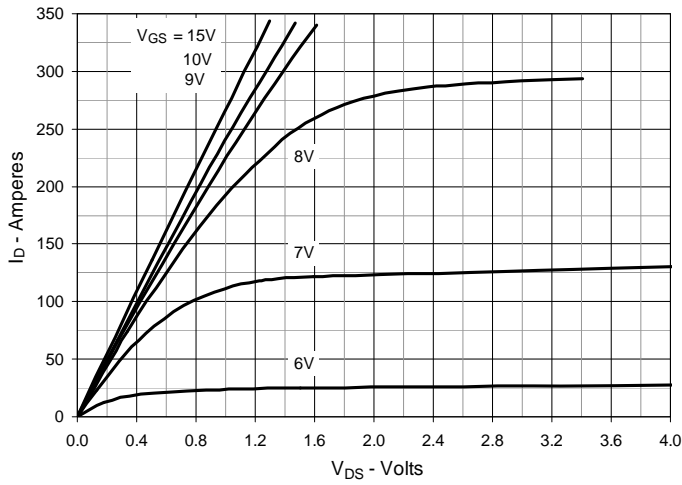

Fig. 2. Output Characteristics @ $T_J = 150^\circ\text{C}$

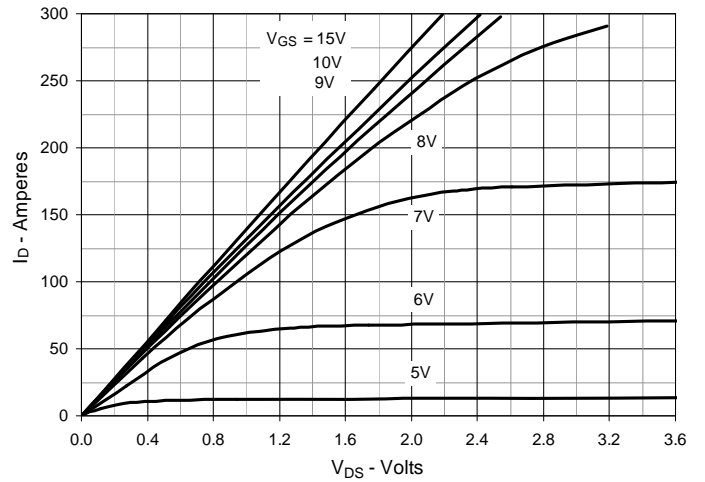

Fig. 3. $R_{DS(on)}$ Normalized to $I_D = 150\text{A}$ Value vs. Junction Temperature

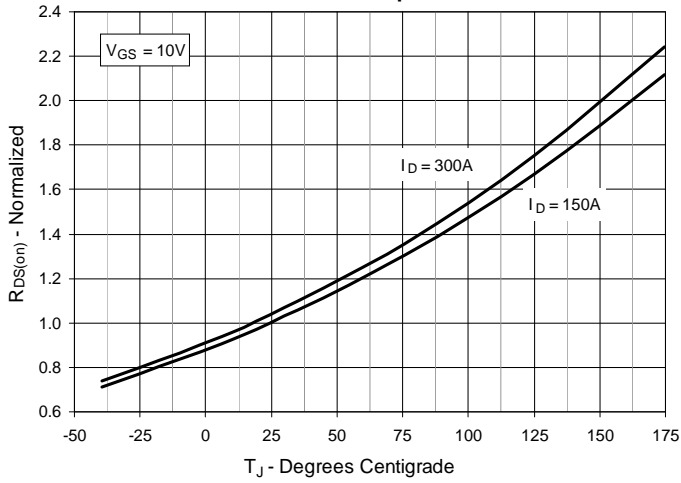

Fig. 4. $R_{DS(on)}$ Normalized to $I_D = 150\text{A}$ Value vs. Drain Current

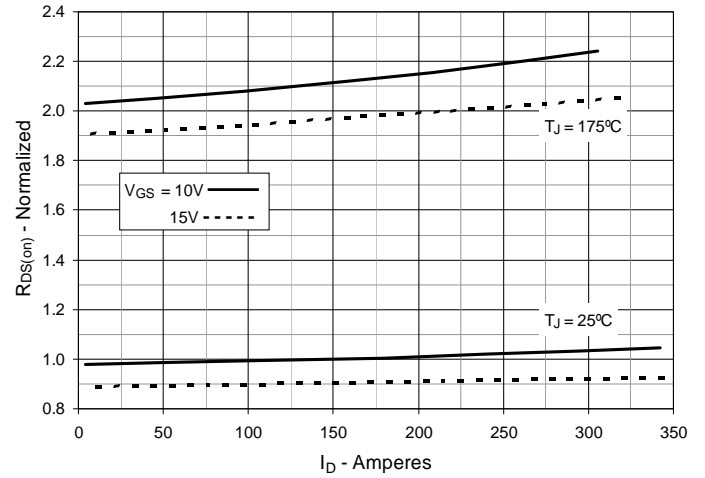

Fig. 5. Maximum Drain Current vs. Case Temperature

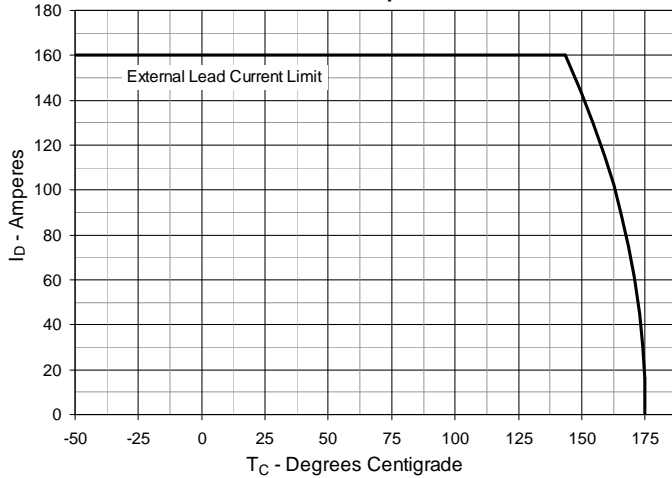

Fig. 6. Input Admittance

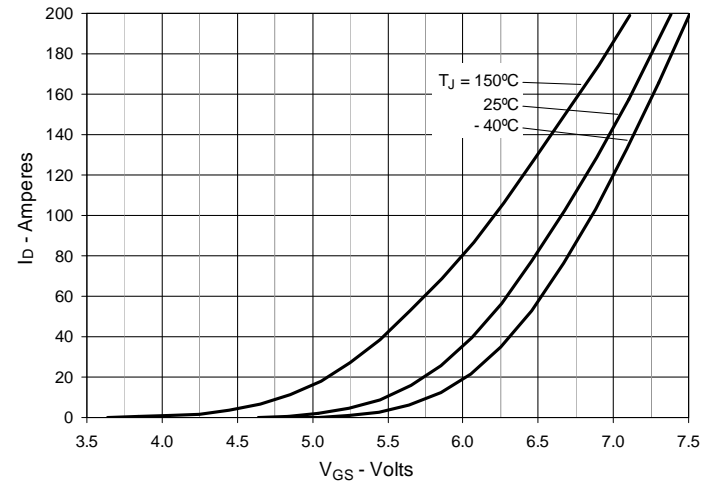

Fig. . Transconductance

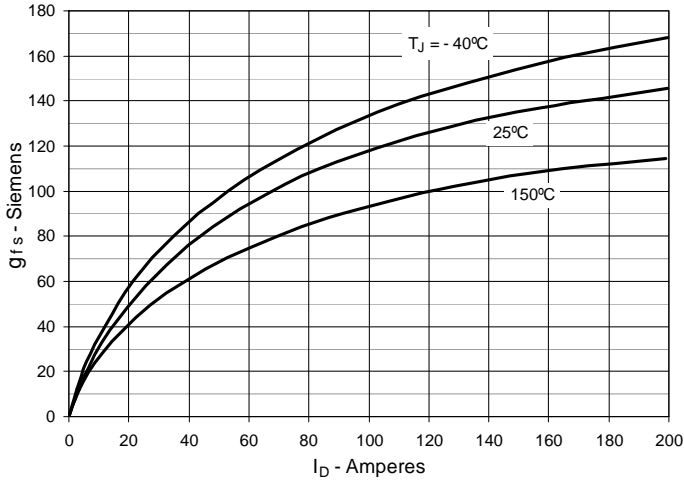

Fig. 8. Forward Voltage Drop of Intrinsic Diode

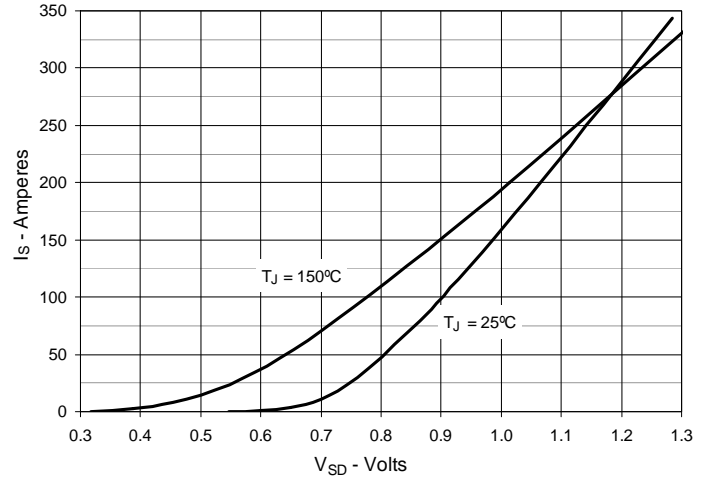

Fig. 9. Gate Charge

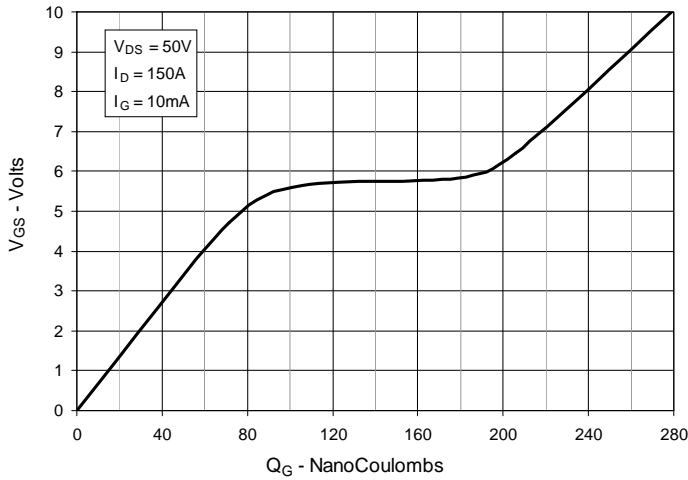

Fig. 10. Capacitance

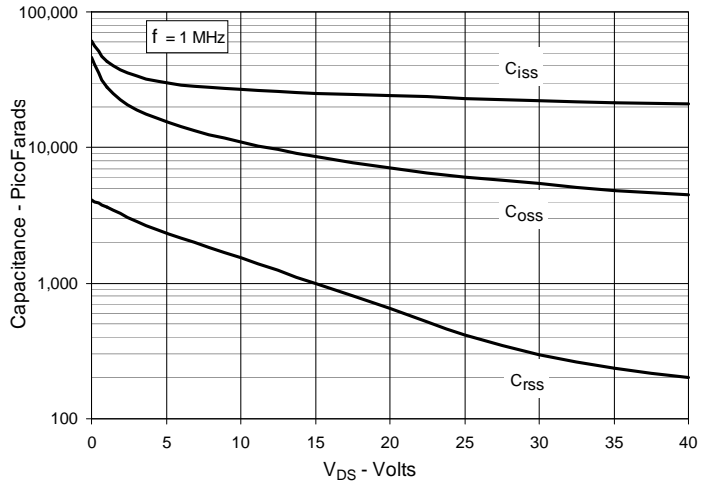

Fig. 11. Forward-Bias Safe Operating Area

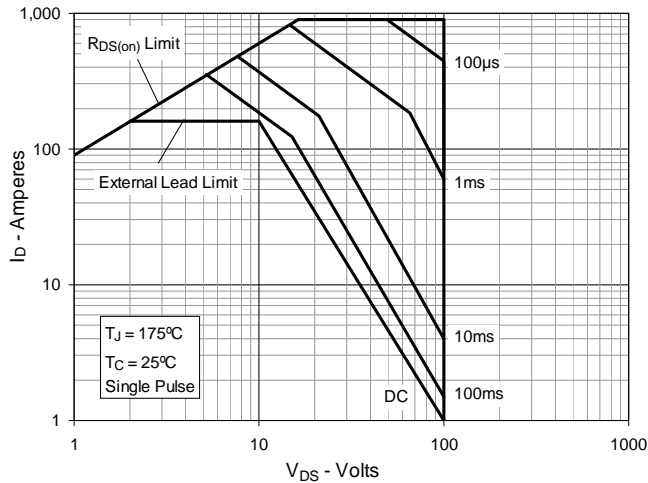
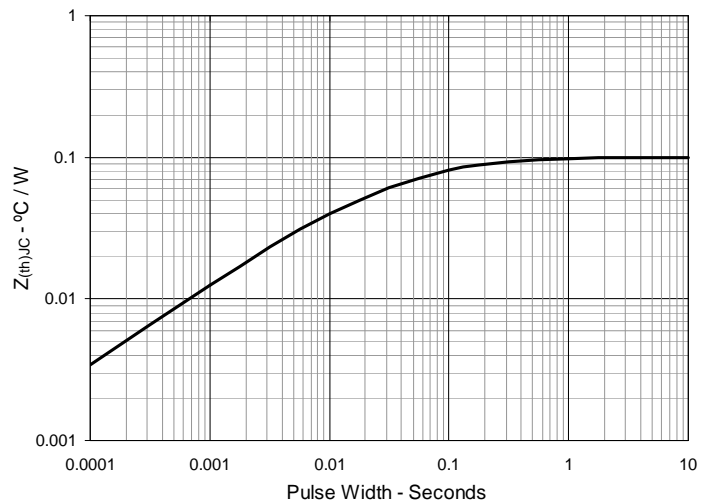

Fig. 12. Maximum Transient Thermal Impedance





Disclaimer Notice - Information furnished is believed to be accurate and reliable. However, users should independently evaluate the suitability of and test each product selected for their own applications. Littelfuse products are not designed for, and may not be used in, all applications. Read complete Disclaimer Notice at www.littelfuse.com/disclaimer-electronics.