

DST860S-A

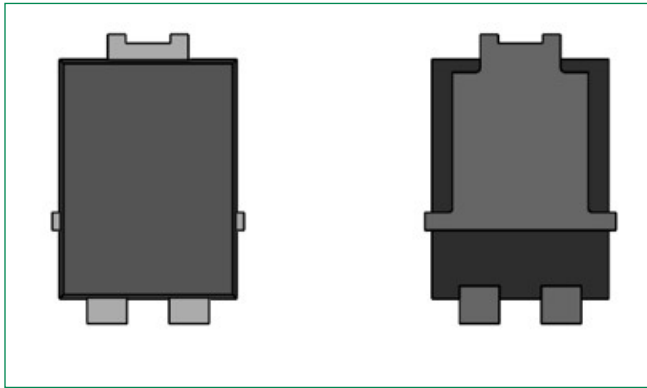

Pin out

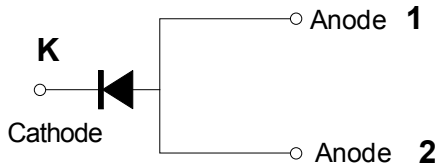

Description

Littelfuse DST series Ultra Low V_F Schottky Barrier Rectifier is designed to meet the general requirements of commercial and industrial applications by providing high temperature, low leakage and lower V_F products.

It is suitable for high frequency switching mode power supply, free-wheeling diodes and polarity protection diodes.

Features

- High reliability application and AEC-Q101 qualified
- Ultra low forward voltage drop
- High frequency operation
- MSL: Level 1 - unlimited
- High junction temperature capability
- Trench MOS Schottky technology
- Single die in TO-277B Package
- Pb-free E3 means 2nd level interconnect is Pb-free and the terminal finish material is tin(Sn) (IPC/ JEDEC J-STD-609A.01)

Applications

- Switching mode power supply
- DC/DC converters
- Free-Wheeling diodes
- Polarity Protection Diodes

Maximum Ratings

Parameters	Symbol	Test Conditions	Max	Unit
Peak Inverse Voltage	V_{RWM}	-	60	V
Average Forward Current	$I_{F(AV)}$	50% duty cycle @ $T_J = 125^\circ\text{C}$ rectangular wave form	8	A
Peak One Cycle Non-Repetitive Surge Current	I_{FSM}	8.3 ms, half Sine pulse	140	A

Electrical Characteristics

Parameters	Symbol	Test Conditions	Typ	Max	Unit
Forward Voltage Drop*	V_{F1}	@4A, Pulse, $T_J = 25^\circ\text{C}$	0.42	-	V
		@8A, Pulse, $T_J = 25^\circ\text{C}$	0.50	0.61	
	V_{F2}	@4A, Pulse, $T_J = 125^\circ\text{C}$	0.34	-	
		@8A, Pulse, $T_J = 125^\circ\text{C}$	0.44	0.55	
Reverse Current*	I_{R1}	@ $V_R = \text{rated } V_R, T_J = 25^\circ\text{C}$	0.02	0.6	mA
	I_{R2}	@ $V_R = \text{rated } V_R, T_J = 125^\circ\text{C}$	10	25	
Junction Capacitance	C_T	@ $V_R = 5V, T_C = 25^\circ\text{C}, f_{SIG} = 1\text{MHz}$	502	-	pF

* Pulse Width < 300 μs , Duty Cycle <2%

Thermal-Mechanical Specifications

Parameters	Symbol	Test Conditions	Max	Unit
Junction Temperature	T_J		-55 to +150	°C
Storage Temperature	T_{stg}		-55 to +150	°C
Maximum Thermal Resistance Junction to Ambient	R_{thJA}	DC operation	75	°C/W
Maximum Thermal Resistance Junction to Lead	R_{thJL}		4	°C/W
Approximate Weight	wt		0.08	g
Case Style		TO-277B		

Figure 1: Typical Forward Characteristics

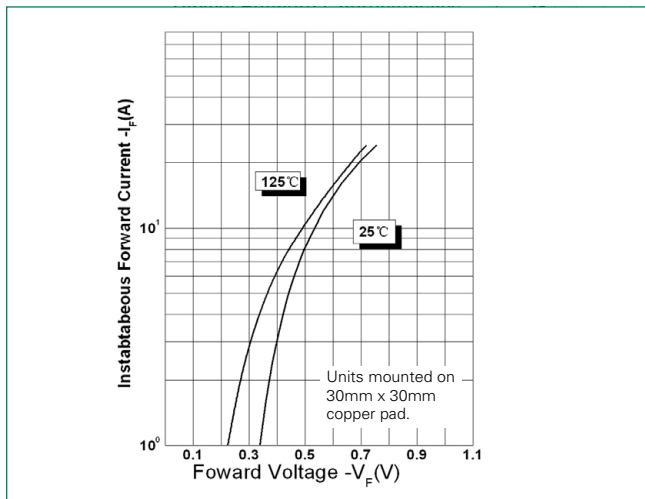

Figure 2: Typical Reverse Characteristics

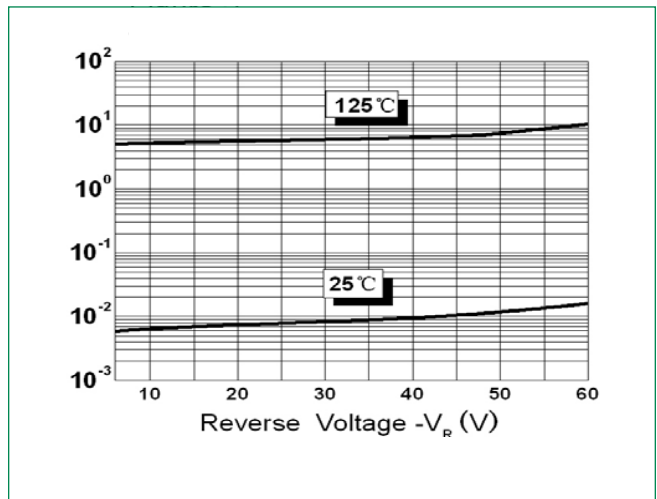
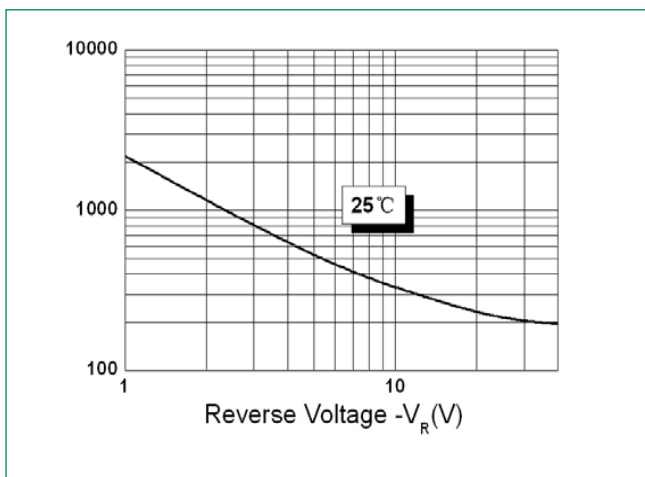
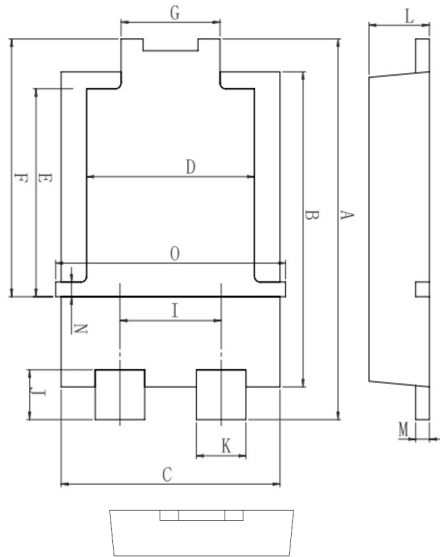

Figure 3: Typical Junction Capacitance



Dimensions-TO-277B



Mounting Pad Layout

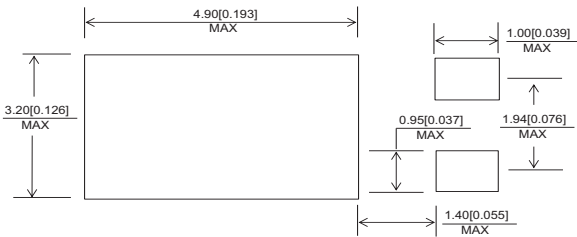

Symbol	Millimeters		
	Min	Typ	Max
A	6.30	6.50	6.70
B	5.28	5.38	5.48
C	3.88	3.98	4.08
D	2.90	3.05	3.20
E	3.40	3.55	3.70
F	4.20	4.40	4.60
G	1.70	1.80	1.90
I	1.74	1.84	1.94
J	0.65	0.85	1.05
K	0.85	0.90	0.95
L	0.95	1.10	1.25
M	0.20	0.25	0.30
N	0.25	0.40	0.55
O	4.00	4.05	4.25

Part Numbering and Marking System

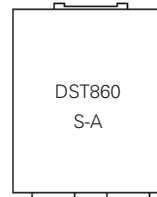

- DST = Device Type
- 10 = Forward Current (10A)
- 80 = Reverse Voltage (80V)
- 60 = Package Type (60V)
- LF = AEC-Q101 qualified device
- YY = Littelfuse Year
- WW = Week
- L = Lot Number

Packing Options

Part Number	Marking	Packing Mode	M.O.Q
DST860S-A	DST860S-A	5000pcs / Reel	5000

Carrier Tape & Reel Specification

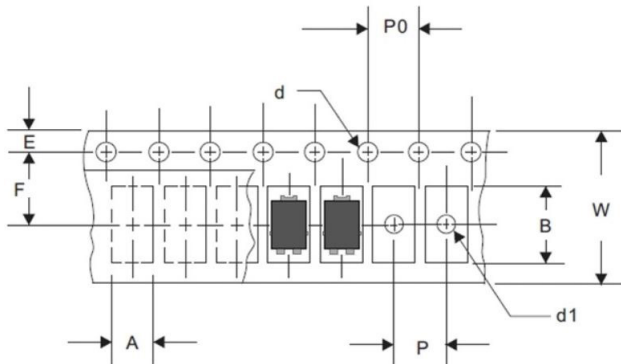

Symbol	Millimeters	
	Min	Max
A	4.28	4.48
B	6.80	7.00
d	1.40	1.60
d1	-	1.50
E	1.65	1.85
F	5.40	5.60
P	7.90	8.10
P0	3.90	4.10
W	11.70	12.30

Disclaimer Notice

Information furnished is believed to be accurate and reliable. However, users should independently evaluate the suitability of and test each product selected for their own applications. Littelfuse products are not designed for, and may not be used in, all applications. Read complete Disclaimer Notice at <http://www.littelfuse.com/disclaimer-electronics>.



Part of:

