

**AQ7520-08UTG**

0.32pF 12kV Diode Array, Low Capacitance ESD Protection

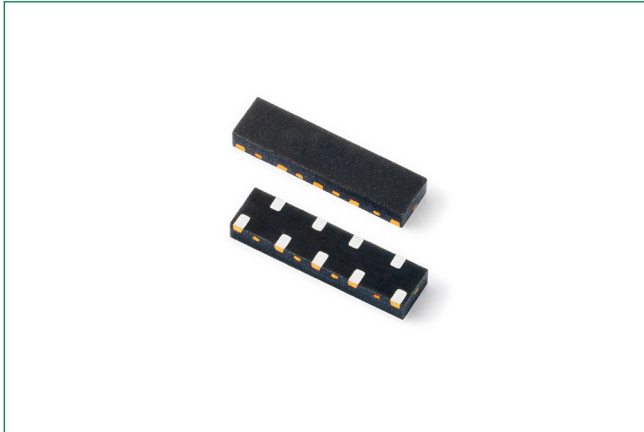
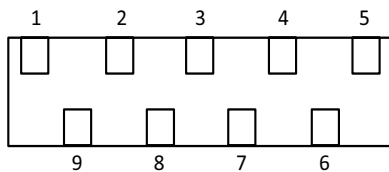
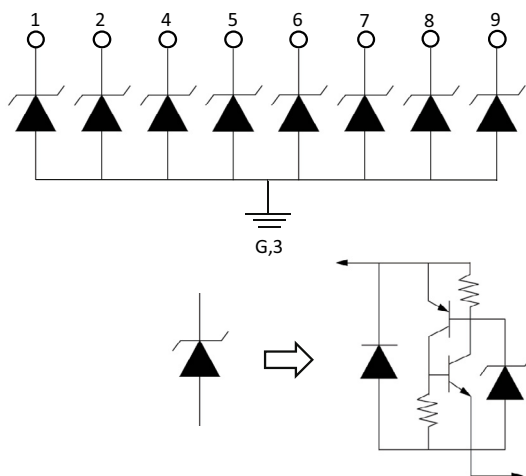

**Note:** This package image is for example and reference only. For detail package drawing, please refer to the package section in this datasheet.

**Pinout****Functional Block Diagram****Description**

The AQ7520-08UTG includes eight channels ultra low capacitance and high-level ESD protection diodes to protect high-speed data rate such as USB 3.1, DisplayPort and e-SATA. The typical capacitance of 0.32pF helps ensure signal integrity and this robust device can safely absorb repetitive ESD strikes at the maximum level specified in the IEC 61000-4-2 international standard (Level 4,  $\pm 8$ kV contact discharge) without performance degradation and safely dissipate 6A of 8/20 $\mu$ s surge current (IEC 61000-4-5 2nd edition).

**Features**

- ESD, IEC 61000-4-2,  $\pm 12$ kV contact,  $\pm 15$ kV air
- ESD, ISO 10605, 330pF 330 $\Omega$ ,  $\pm 12$ kV contact,  $\pm 12$ kV air
- EFT, IEC 61000-4-4, 40A (5/50ns)
- Maximum surge tolerance, IEC 61000-4-5 2<sup>nd</sup> edition, 6A ( $t_p=8/20\mu$ s)
- Low capacitance of 0.32pF@1.5V (TYP)
- Low leakage current of 0.02 $\mu$ A (TYP) at 3.3V
- Low operating and clamping voltage
- AEC-Q101 qualified and PPAP capable
- Halogen free, Lead free and RoHS compliant
- Moisture Sensitivity Level (MSL -1)

**Applications**

- V-By-One
- Embedded DisplayPort
- USB 2.0/3.0/3.1 Ports
- Automotive
- Flat Panel Displays
- LCD/LED TVs
- Smartphones
- Mobile Computing

**Life Support Note:**

Not Intended for Use in Life Support or Life Saving Applications  
The products shown herein are not designed for use in life sustaining or life saving applications unless otherwise expressly indicated.

**AQ7520-08UTG**

0.32pF 12kV Diode Array, Low Capacitance ESD Protection

**Absolute Maximum Ratings**

Symbol	Parameter	Value	Units
$I_{PP}$	Peak Current ( $t_p=8/20\mu s$ )	6.0	A
$T_{OP}$	Operating Temperature	-40 to 150	°C
$T_{STOR}$	Storage Temperature	-55 to 150	°C

**Caution:** Stresses above those listed in "Absolute Maximum Ratings" may cause permanent damage to the component. This is a stress only rating and operation of the component at these or any other conditions above those indicated in the operational sections of this specification is not implied.

**Electrical Characteristics ( $T_{OP}=25^\circ C$ )**

Parameter	Symbol	Test Conditions	Min	Typ	Max	Units
Reverse Standoff Voltage	$V_{RWM}$	Pin-1,-2,-4,-5,-6,-7,-8,-9 to pin-3			3.3	V
Breakdown Voltage	$V_{BR}$	$I_R=1mA$	6.5	8.5		V
Reverse Leakage Current	$I_{LEAK}$	$V_R=3.3V$		0.02	0.1	$\mu A$
Holding Voltage	$V_{HOLD}$	I/O to GND		1.7		V
Clamp Voltage <sup>1</sup>	$V_C$	$I_{PP}=1A, t_p=8/20\mu s$		2.7	3.5	V
		$I_{PP}=6A, t_p=8/20\mu s$		4.0	6.0	
Dynamic Resistance <sup>2</sup>	$R_{DYN}$	TLP, $t_p=100ns$		0.25		$\Omega$
ESD Withstand Voltage <sup>1,3</sup>	$V_{ESD}$	IEC 61000-4-2 (Contact Discharge)	$\pm 12$			kV
		IEC 61000-4-2 (Air Discharge)	$\pm 15$			kV
Diode Capacitance <sup>1</sup>	$C_{I/O-GND}$	Reverse Bias=1.5V, $f=1MHz$		0.32	0.4	pF

**Notes:**

- Parameter is guaranteed by design and/or component characterization.
- Transmission Line Pulse (TLP) with 100ns width, 0.2ns rise time, and average window  $t1=70ns$  to  $t2=90ns$
- Device stressed with ten non-repetitive ESD pulses.

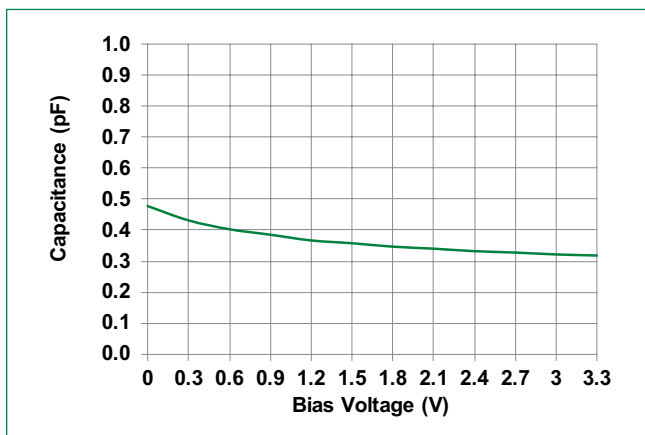
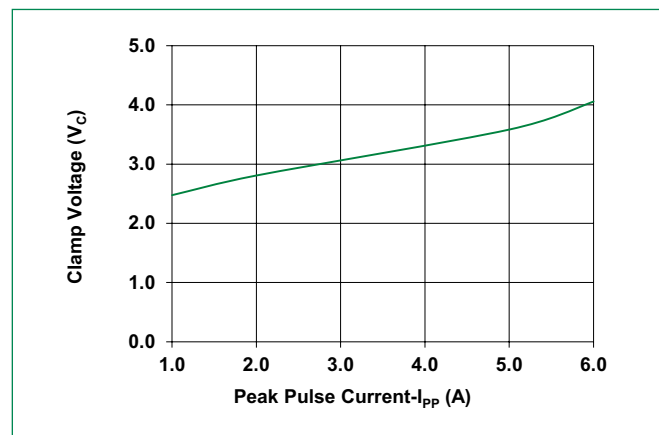
**Capacitance vs. Reverse Bias****Clamping Voltage vs  $I_{PP}$** 

# AQ7520-08UTG

## 0.32pF 12kV Diode Array, Low Capacitance ESD Protection

Positive Transmission Line Pulsing (TLP) Plot

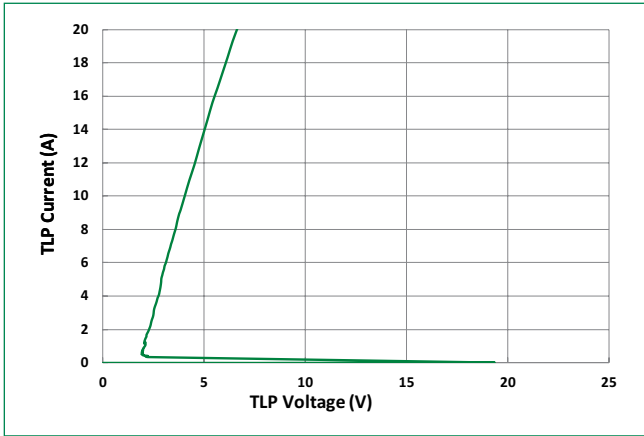

Negative Transmission Line Pulsing (TLP) Plot

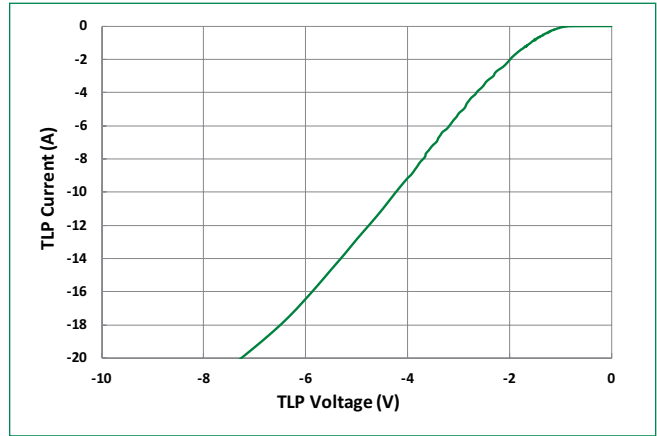

IEC 61000-4-2 +8 kV Contact ESD Clamping Voltage



IEC 61000-4-2 -8 kV Contact ESD Clamping Voltage

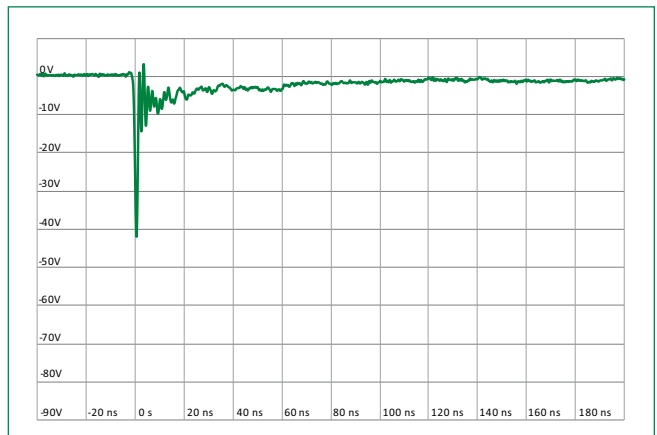

ISO10605 Contact Discharge Plot at +8KV



ISO10605 Contact Discharge Plot at -8 kV



# AQ7520-08UTG

## 0.32pF 12kV Diode Array, Low Capacitance ESD Protection

### Soldering Parameters

<b>Reflow Condition</b>	Pb – Free assembly	
<b>Pre Heat</b>	- Temperature Min ( $T_{s(min)}$ )	150°C
	- Temperature Max ( $T_{s(max)}$ )	200°C
	- Time (min to max) ( $t_s$ )	60 – 120 secs
<b>Average ramp up rate (Liquidus) Temp (<math>T_L</math>) to peak</b>	3°C/second max	
<b><math>T_{S(max)}</math> to <math>T_L</math> - Ramp-up Rate</b>	3°C/second max	
<b>Reflow</b>	- Temperature ( $T_L$ ) (Liquidus)	217°C
	- Temperature ( $t_L$ )	60 – 150 seconds
<b>Peak Temperature (<math>T_p</math>)</b>	260 <sup>+0/-5</sup> °C	
<b>Time within 5°C of actual peak Temperature (<math>t_p</math>)</b>	30 seconds	
<b>Ramp-down Rate</b>	6°C/second max	
<b>Time 25°C to peak Temperature (<math>T_p</math>)</b>	8 minutes Max.	
<b>Do not exceed</b>	260°C	

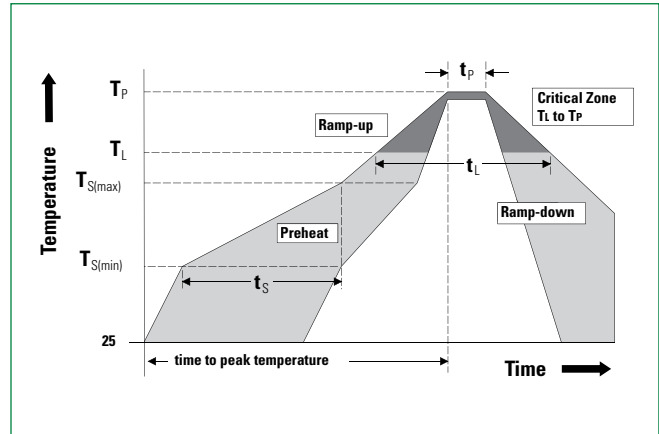

### Ordering Information

Part Number	Package	Min. Order Qty.
AQ7520-08UTG	μDFN-9	3000

### Product Characteristics

<b>Lead Plating</b>	Matte Tin
<b>Lead material</b>	Copper Alloy
<b>Substrate Material</b>	Silicon
<b>Body Material</b>	Molded Compound
<b>Flammability</b>	UL Recognized compound meeting flammability rating V-0

### Part Marking System

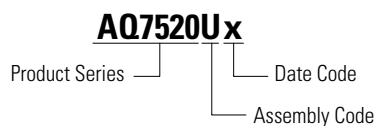

### Part Numbering System

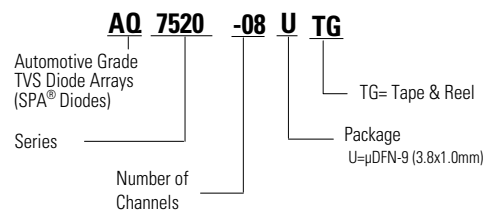

**AQ7520-08UTG**

0.32pF 12kV Diode Array, Low Capacitance ESD Protection

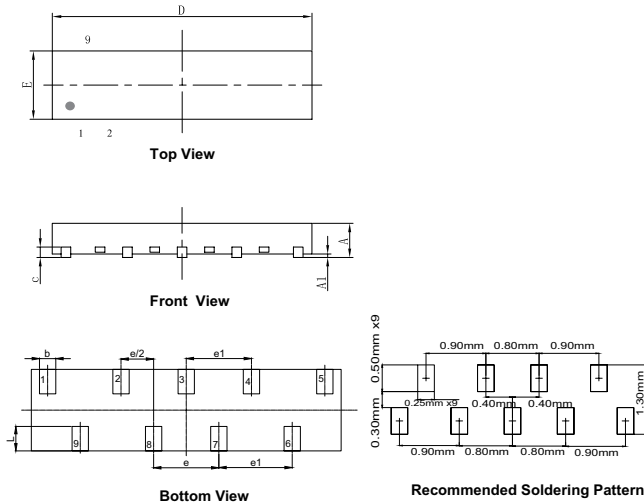
**Package Dimensions**

µDFN-9 (3.8x1.0mm)						
Symbol	Millimeters			Inches		
	Min	Nom	Max	Min	Nom	Max
<b>A</b>	0.45	0.50	0.55	0.018	0.020	0.022
<b>A1</b>	-	0.02	0.05	-	0.001	0.002
<b>b</b>	0.15	0.20	0.25	0.006	0.008	0.010
<b>c</b>	0.10	0.15	0.20	0.004	0.006	0.008
<b>D</b>	3.70	3.80	3.90	0.146	0.150	0.154
<b>e</b>	0.80 BSC			0.031 BSC		
<b>e1</b>	0.90 BSC			0.035 BSC		
<b>E</b>	0.90	1.00	1.10	0.035	0.039	0.043
<b>L</b>	0.20	0.30	0.40	0.008	0.012	0.016

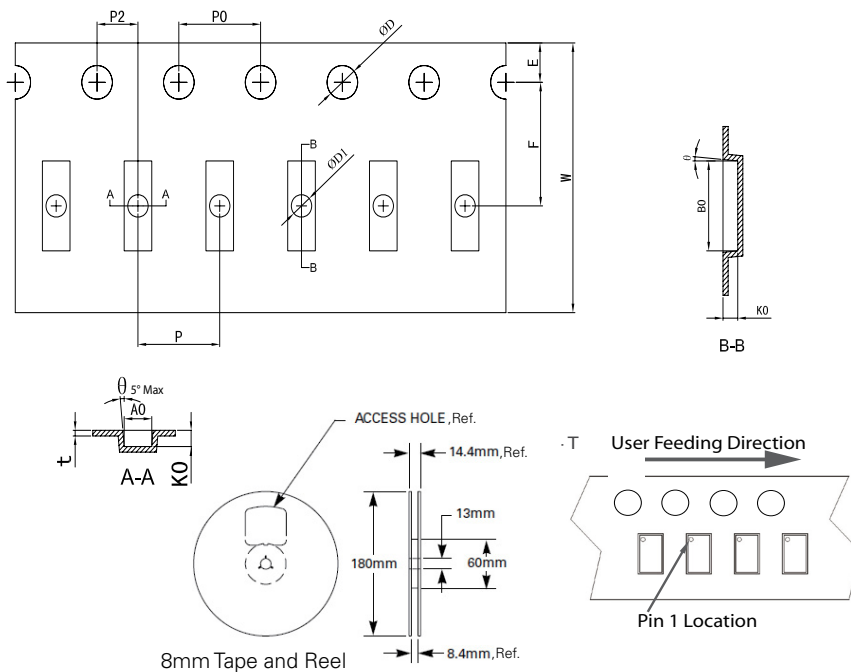
**Embossed Carrier Tape & Reel Specification**

Symbol	Millimeters
<b>A0</b>	1.35 +/- 0.10
<b>B0</b>	4.00 +/- 0.05
<b>D</b>	Ø 1.50 + 0.1/ -0
<b>D1</b>	Ø 1.00 +/- 0.05
<b>E</b>	1.75 +/- 0.10
<b>F</b>	5.50 +/- 0.05
<b>K0</b>	0.72 +/- 0.05
<b>P</b>	4.00 +/- 0.10
<b>P0</b>	4.00 +/- 0.10
<b>P2</b>	2.00 +/- 0.05
<b>T</b>	0.25 +/- 0.02
<b>W</b>	12.00 + 0.30 /- 0.10

**Product Disclaimer:** Littelfuse products are not designed for, and shall not be used for, any purpose (including, without limitation, automotive, military, aerospace, medical, life-saving, life-sustaining or nuclear facility applications, devices intended for surgical implant into the body, or any other application in which the failure or lack of desired operation of the product may result in personal injury, death, or property damage) other than those expressly set forth in applicable Littelfuse product documentation. Warranties granted by Littelfuse shall be deemed void for products used for any purpose not expressly set forth in applicable Littelfuse documentation. Littelfuse shall not be liable for any claims or damages arising out of products used in applications not expressly intended by Littelfuse as set forth in applicable Littelfuse documentation. The sale and use of Littelfuse products is subject to Littelfuse Terms and Conditions of Sale, unless otherwise agreed by Littelfuse. "Littelfuse" includes Littelfuse, Inc., and all of its affiliate entities. <http://www.littelfuse.com/disclaimer-electronics>