

High Voltage, High Gain BiMOSFET™

IXBL64N250

$V_{CES} = 2500V$
 $I_{C110} = 46A$
 $V_{CE(sat)} \leq 3.0V$

Monolithic Bipolar MOS Transistor

(Electrically Isolated Tab)

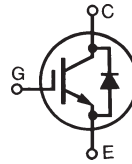

ISOPLUS i5-Pak™

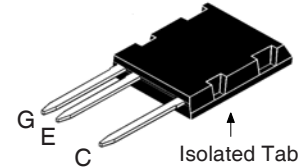

G = Gate C = Collector
E = Emitter

Symbol	Test Conditions	Maximum Ratings	
V_{CES}	$T_J = 25^\circ C$ to $150^\circ C$	2500	V
V_{CGR}	$T_J = 25^\circ C$ to $150^\circ C$, $R_{GE} = 1M\Omega$	2500	V
V_{GES}	Continuous	± 25	V
V_{GEM}	Transient	± 35	V
I_{C25}	$T_C = 25^\circ C$	116	A
I_{C110}	$T_C = 110^\circ C$	46	A
I_{CM}	$T_C = 25^\circ C$, 1ms	750	A
SSOA	$V_{GE} = 15V$, $T_{VJ} = 125^\circ C$, $R_G = 1\Omega$	$I_{CM} = 160$	A
(RBSOA)	Clamped Inductive Load	$V_{CE} \leq 0.8 \cdot V_{CES}$	
T_{SC} (SCSOA)	$V_{GE} = 15V$, $T_J = 125^\circ C$ $R_G = 5\Omega$, $V_{CE} = 1250V$, Non-Repetitive	10	μs
P_C	$T_C = 25^\circ C$	500	W
T_J		-55 ... +150	$^\circ C$
T_{JM}		150	$^\circ C$
T_{stg}		-55 ... +150	$^\circ C$
T_L	Maximum Lead Temperature for Soldering	300	$^\circ C$
T_{SOLD}	1.6 mm (0.062 in.) from Case for 10	260	$^\circ C$
V_{ISOL}	50/60Hz, 1 minute	2500	V~
F_C	Mounting Force with Clip	30..170 / 7..36	Nm/lb-in.
Weight		8	g

Features

- Silicon Chip on Direct-Copper Bond (DCB) Substrate
- Isolated Mounting Surface
- 2500V~ Electrical Isolation
- High Blocking Voltage
- Low Switching Losses
- High Current Handling Capability
- Anti-Parallel Diode

Advantages

- High Power Density
- Low Gate Drive Requirement

Applications

- Switch-Mode and Resonant-Mode Power Supplies
- Uninterrupted Power Supplies (UPS)
- Capacitor Discharge Circuits
- Laser Generators

Symbol	Test Conditions ($T_J = 25^\circ C$, Unless Otherwise Specified)	Characteristic Values		
		Min.	Typ.	Max.
BV_{CES}	$I_C = 1mA$, $V_{GE} = 0V$	2500		V
$V_{GE(th)}$	$I_C = 4mA$, $V_{CE} = V_{GE}$	3.0		5.0 V
I_{CES}	$V_{CE} = 0.8 \cdot V_{CES}$, $V_{GE} = 0V$ Note 2, $T_J = 125^\circ C$			50 μA 6 mA
I_{GES}	$V_{CE} = 0V$, $V_{GE} = \pm 25V$			± 200 nA
$V_{CE(sat)}$	$I_C = 64A$, $V_{GE} = 15V$, Note 1 $T_J = 125^\circ C$		2.5 3.1	3.0 V V

Symbol Test Conditions ($T_J = 25^\circ\text{C}$ Unless Otherwise Specified)		Characteristic Values		
		Min.	Typ.	Max.
g_{fs}	$I_C = 64\text{A}, V_{CE} = 10\text{V}, \text{Note 1}$	40	72	S
C_{ies}	$V_{CE} = 25\text{V}, V_{GE} = 0\text{V}, f = 1\text{MHz}$		8900	pF
C_{oes}			345	pF
C_{res}			118	pF
Q_g	$I_C = 64\text{A}, V_{GE} = 15\text{V}, V_{CE} = 600\text{V}$		400	nC
Q_{ge}			46	nC
Q_{gc}			155	nC
$t_{d(on)}$	Resistive Switching Times, $T_J = 25^\circ\text{C}$ $I_C = 128\text{A}, V_{GE} = 15\text{V}$ $V_{CE} = 1250\text{V}, R_G = 1\Omega$		49	ns
t_r			318	ns
$t_{d(off)}$			232	ns
t_f			170	ns
$t_{d(on)}$	Resistive Switching Times, $T_J = 125^\circ\text{C}$ $I_C = 128\text{A}, V_{GE} = 15\text{V}$ $V_{CE} = 1250\text{V}, R_G = 1\Omega$		54	ns
t_r			578	ns
$t_{d(off)}$			222	ns
t_f			175	ns
R_{thJC}				0.25 °C/W
R_{thCS}		0.15		°C/W

ISOPLUS i5-Pak™ HV (IXBL) Outline

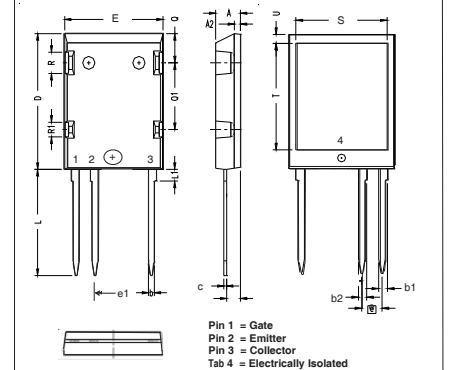

SYM	INCHES		MILLIMETER	
	MIN	MAX	MIN	MAX
A	0.190	0.205	4.83	5.21
A1	0.102	0.118	2.59	3.00
A2	0.046	0.055	1.17	1.40
b	0.045	0.055	1.14	1.40
b1	0.063	0.072	1.60	1.83
b2	0.058	0.068	1.47	1.73
c	0.020	0.029	0.51	0.74
D	1.020	1.040	25.91	26.42
E	0.770	0.799	19.56	20.29
e	0.150 BSC		3.81 BSC	
e1	0.450 BSC		11.43 BSC	
L	0.780	0.820	19.81	20.83
L1	0.080	0.102	2.03	2.59
Q	0.210	0.235	5.33	5.97
Q1	0.490	0.513	12.45	13.03
R	0.150	0.180	3.81	4.57
R1	0.100	0.130	2.54	3.30
S	0.668	0.690	16.97	17.53
T	0.801	0.821	20.34	20.85
U	0.065	0.080	1.65	2.03

Reverse Diode

Symbol Test Conditions ($T_J = 25^\circ\text{C}$ Unless Otherwise Specified)		Characteristic Values		
		Min.	Typ.	Max.
V_F	$I_F = 64\text{A}, V_{GE} = 0\text{V}, \text{Note 1}$			3.0 V
t_{rr}	$I_F = 64\text{A}, V_{GE} = 0\text{V}, -di_F/dt = 650\text{A}/\mu\text{s}$		160	ns
I_{RM}		$V_R = 600\text{V}, V_{GE} = 0\text{V}$		480

Notes:

1. Pulse test, $t \leq 300\mu\text{s}$, duty cycle, $d \leq 2\%$.
2. Part must be heatsunk for high-temp I_{ces} measurement.

Additional provisions for lead-to-lead isolation are required at $V_{CE} > 1200\text{V}$.

IXYS Reserves the Right to Change Limits, Test Conditions, and Dimensions.

IXYS MOSFETs and IGBTs are covered by one or more of the following U.S. patents:	4,835,592	4,931,844	5,049,961	5,237,481	6,162,665	6,404,065 B1	6,683,344	6,727,585	7,005,734 B2	7,157,338B2
	4,860,072	5,017,508	5,063,307	5,381,025	6,259,123 B1	6,534,343	6,710,405 B2	6,759,692	7,063,975 B2	
	4,881,106	5,034,796	5,187,117	5,486,715	6,306,728 B1	6,583,505	6,710,463	6,771,478 B2	7,071,537	

Fig. 1. Output Characteristics @ $T_J = 25^\circ\text{C}$

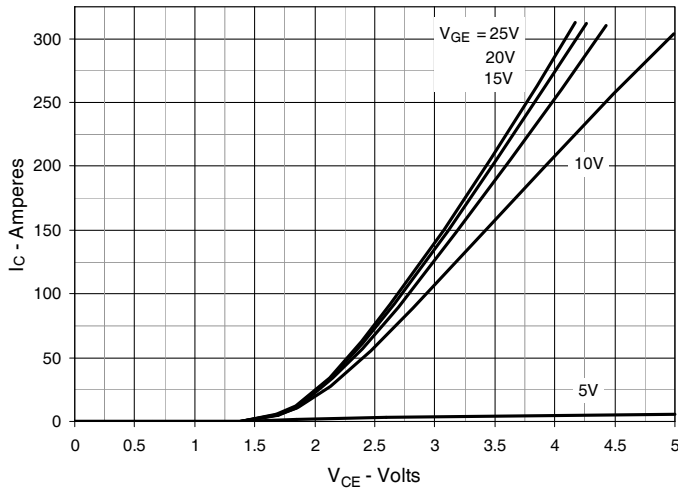

Fig. 2. Output Characteristics @ $T_J = 125^\circ\text{C}$

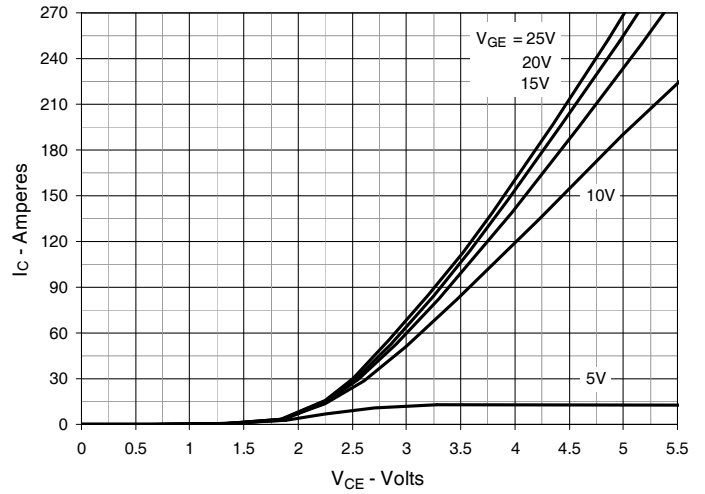

Fig. 3. Dependence of $V_{CE(sat)}$ on Junction Temperature

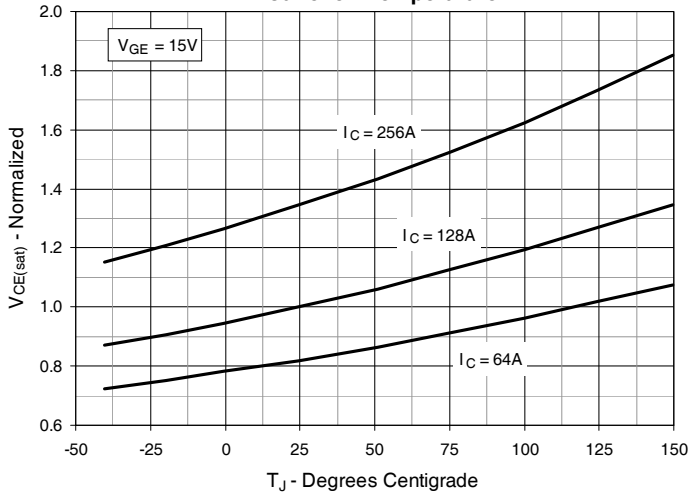

Fig. 4. Collector-to-Emitter Voltage vs. Gate-to-Emitter Voltage

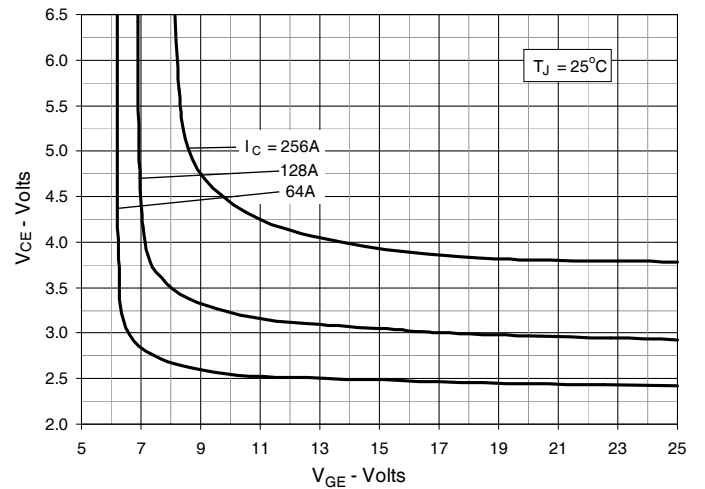

Fig. 5. Breakdown & Threshold Voltages vs. Junction Temperature

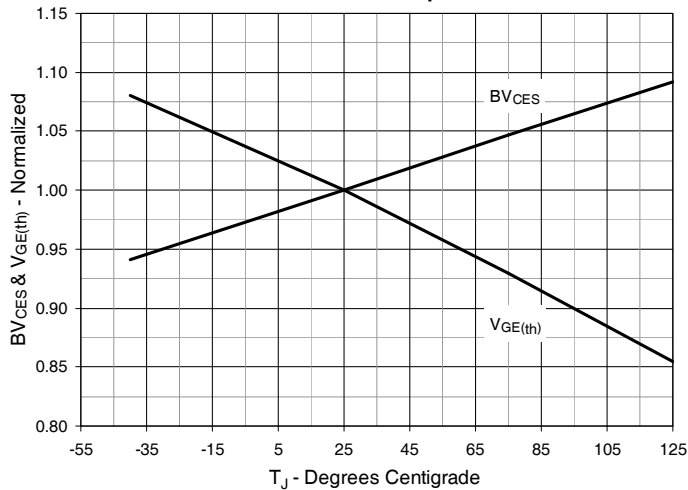

Fig. 6. Input Admittance

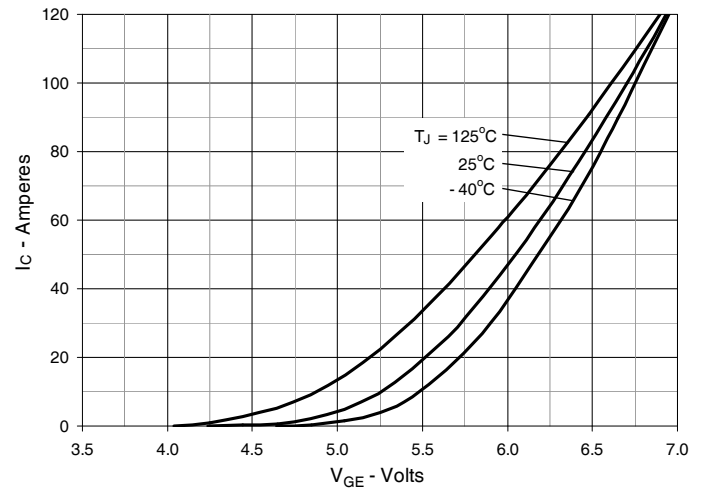

Fig. 7. Transconductance

Fig. 8. Forward Voltage Drop of Intrinsic Diode

Fig. 9. Gate Charge

Fig. 10. Capacitance

Fig. 11. Reverse-Bias Safe Operating Area

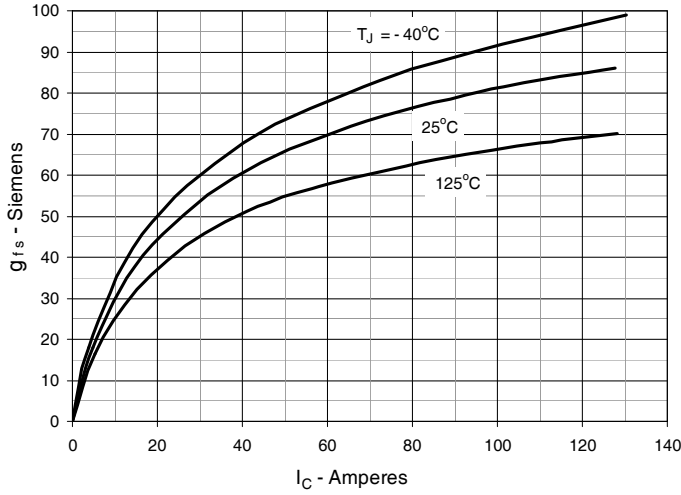
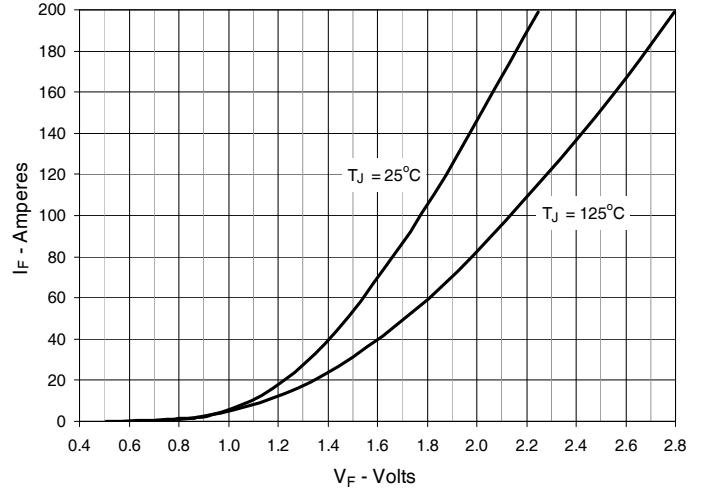
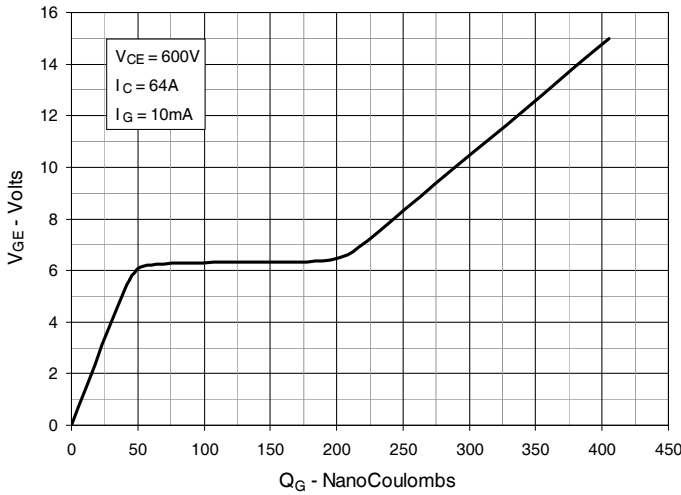
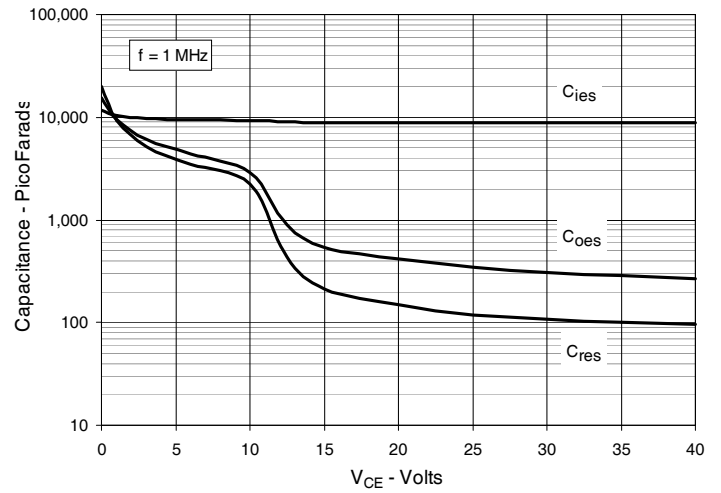
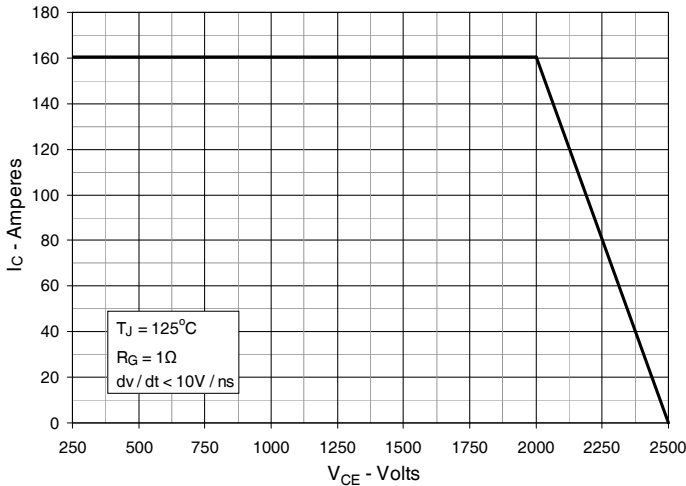
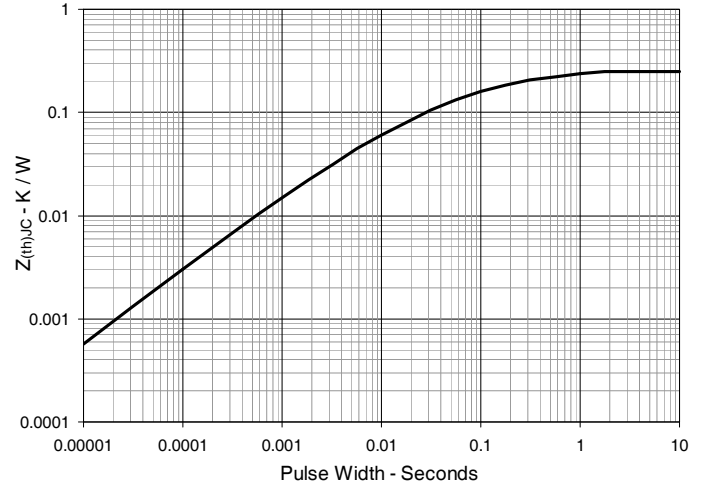
Fig. 12. Maximum Transient Thermal Impedance

Fig. 13. Resistive Turn-on Rise Time vs. Junction Temperature

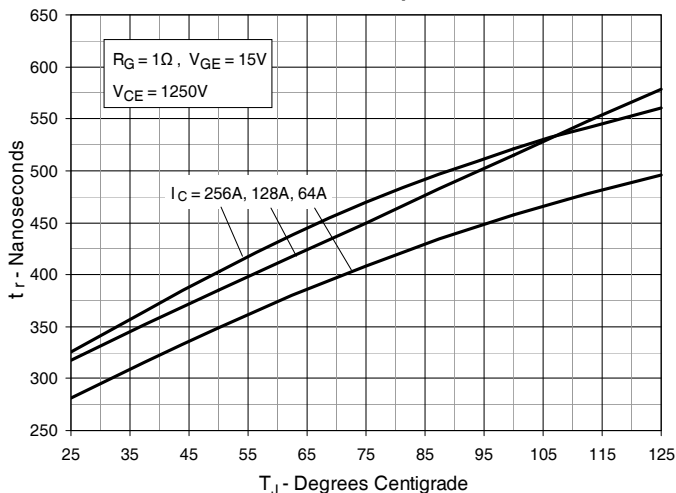

Fig. 14. Resistive Turn-on Rise Time vs. Drain Current

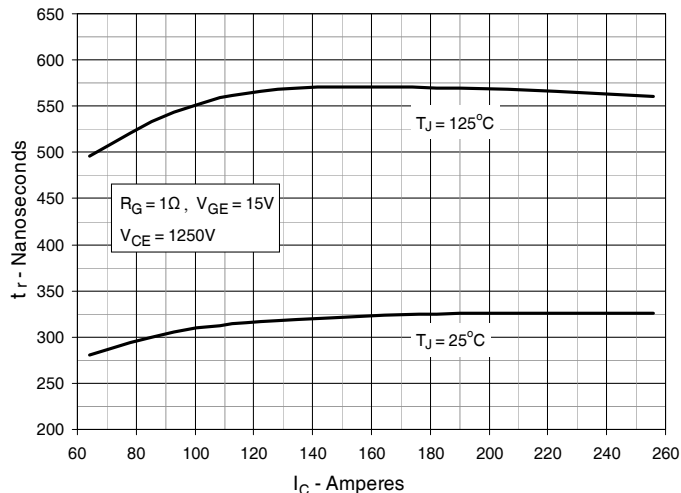

Fig. 15. Resistive Turn-on Switching Times vs. Gate Resistance

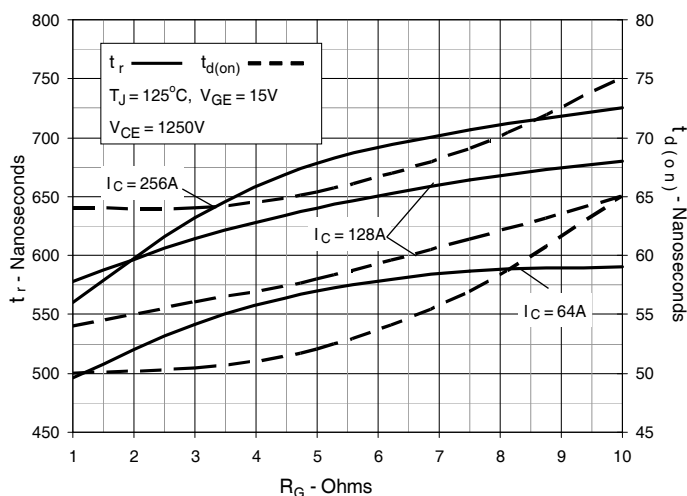

Fig. 16. Resistive Turn-off Switching Times vs. Junction Temperature

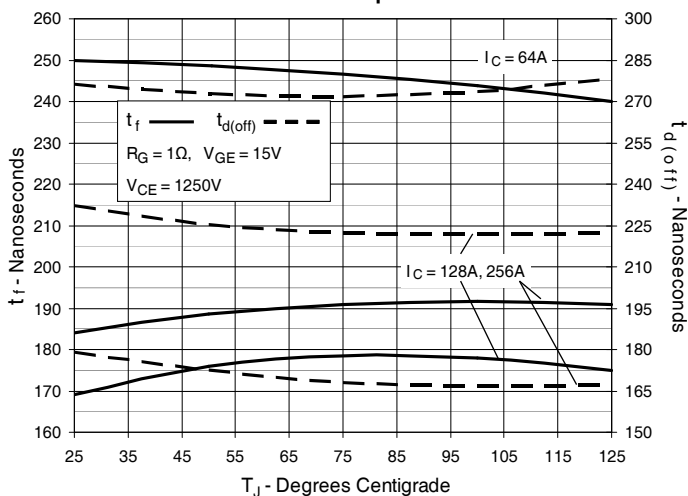

Fig. 17. Resistive Turn-off Switching Times vs. Drain Current

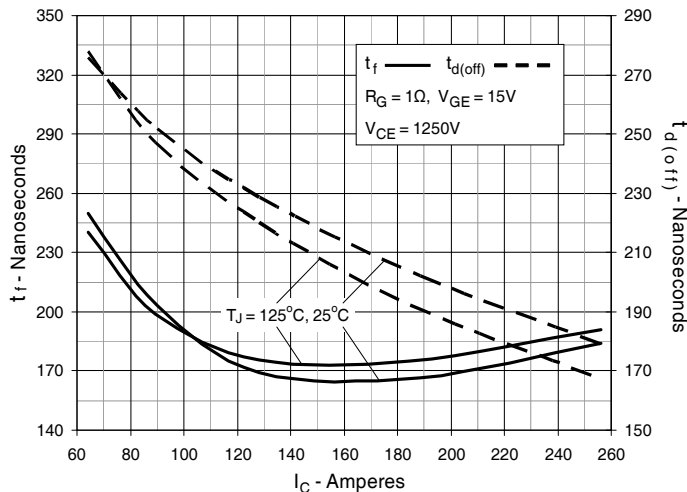

Fig. 18. Resistive Turn-off Switching Times vs. Gate Resistance

